

Intel® Desktop Board DX58S02 Product Guide

Order Number: G13825-001

Revision History

Revision	Revision History	Date
-001	First release of the Intel® Desktop Board DX58SO2 Product Guide	November 2010

Disclaimer

INFORMATION IN THIS DOCUMENT IS PROVIDED IN CONNECTION WITH INTEL® PRODUCTS. NO LICENSE, EXPRESS OR IMPLIED, BY ESTOPPEL OR OTHERWISE, TO ANY INTELLECTUAL PROPERTY RIGHTS IS GRANTED BY THIS DOCUMENT. EXCEPT AS PROVIDED IN INTEL'S TERMS AND CONDITIONS OF SALE FOR SUCH PRODUCTS, INTEL ASSUMES NO LIABILITY WHATSOEVER, AND INTEL DISCLAIMS ANY EXPRESS OR IMPLIED WARRANTY, RELATING TO SALE AND/OR USE OF INTEL PRODUCTS INCLUDING LIABILITY OR WARRANTIES RELATING TO FITNESS FOR A PARTICULAR PURPOSE, MERCHANTABILITY, OR INFRINGEMENT OF ANY PATENT, COPYRIGHT OR OTHER INTELLECTUAL PROPERTY RIGHT. Intel products are not intended for use in medical, life saving, or life sustaining applications. Intel may make changes to specifications and product descriptions at any time, without notice.

Intel Desktop Board DX58SO2 may contain design defects or errors known as errata which may cause the product to deviate from published specifications. Current characterized errata are available on request. Contact your local Intel sales office or your distributor to obtain the latest specifications and before placing your product order.

Copies of documents which have an ordering number and are referenced in this document, or other Intel literature, may be obtained from Intel Corporation by going to the World Wide Web site at: <http://www.intel.com/> or by calling 1-800-548-4725.

Intel, Intel Core, and Xeon are trademarks of Intel Corporation in the United States and other countries.

* Other names and brands may be claimed as the property of others.

Copyright © 2010, Intel Corporation. All rights reserved.

Preface

This Product Guide gives information about board layout, component installation, BIOS update, and regulatory requirements for Intel® Desktop Board DX58S02.

Intended Audience

The Product Guide is intended for technically qualified personnel. It is not intended for general audiences.

Use Only for Intended Applications

All Intel Desktop Boards are evaluated as Information Technology Equipment (I.T.E.) for use in personal computers (PC) for installation in homes, offices, schools, computer rooms, and similar locations. The suitability of this product for other PC or embedded non-PC applications or other environments, such as medical, industrial, alarm systems, test equipment, etc. may not be supported without further evaluation by Intel.

Document Organization

The chapters in this Product Guide are arranged as follows:

- 1 Desktop Board Features: a summary of product features
- 2 Installing and Replacing Desktop Board Components: instructions on how to install the Desktop Board and other hardware components
- 3 Updating the BIOS: instructions on how to update the BIOS
- 4 Configuring for RAID: information about configuring your system for RAID
- A Error Messages and Indicators: information about BIOS error messages and beep codes
- B Regulatory Compliance: describes the board's adherence to safety standards and EMC regulations and its product certifications

Conventions

The following conventions are used in this manual:



CAUTION

Cautions warn the user about how to prevent damage to hardware or loss of data.



NOTE

Notes call attention to important information.

Terminology

The table below gives descriptions of some common terms used in the product guide.

Term	Description
GB	Gigabyte (1,073,741,824 bytes)
GHz	Gigahertz (one billion hertz)
KB	Kilobyte (1024 bytes)
MB	Megabyte (1,048,576 bytes)
Mb	Megabit (1,048,576 bits)
MHz	Megahertz (one million hertz)

Contents

1 Desktop Board Features

Supported Operating Systems.....	11
Desktop Board Components.....	12
Processor.....	14
Main Memory.....	15
Intel® X58 Express Chipset.....	16
Audio Subsystem	16
LAN Subsystem	17
USB 2.0 Support.....	18
Serial ATA.....	18
Legacy I/O.....	19
Expandability.....	19
BIOS.....	19
Serial ATA and IDE Auto Configuration.....	19
PCI and PCI Express* Auto Configuration	19
Security Passwords.....	20
Back to BIOS Button	20
Hardware Management	21
Hardware Monitoring and Fan Speed Control	21
Intel® Precision Cooling Technology	21
Chassis Intrusion.....	21
Power Management.....	21
Software Support	22
ACPI.....	22
Hardware Support	22
Power Connectors	22
Fan Headers	22
LAN Wake Capabilities.....	22
Instantly Available PC Technology.....	23
+5 V Standby Power Indicator.....	23
Wake from USB	24
PME# Signal Wake-up Support.....	24
WAKE# Signal Wake-up Support	24
Wake from Consumer IR	25
Onboard System Control Switches	25
Base Clock Frequency Increase Switch.....	26
Base Clock Frequency Decrease Switch.....	26
Power Switch	26
Reset Switch.....	26
Diagnostic/Status LEDs	27
Diagnostic LEDs	28
CPU and VR Hot LEDs.....	29
SATA Drive Activity LED	29
Speaker.....	29
Battery	29
Real-Time Clock.....	29

2 Installing and Replacing Desktop Board Components

Before You Begin	31
Installation Precautions.....	32
Prevent Power Supply Overload	32
Observe Safety and Regulatory Requirements.....	32
Installing the I/O Shield	33
Installing and Removing the Desktop Board	34
Installing and Removing a Processor	35
Installing a Processor	35
Installing the Processor Fan Heat Sink	39
Connecting the Processor Fan Heat Sink Cable.....	39
Removing the Processor	40
Installing and Removing Memory.....	40
Installing DIMMs	41
Removing DIMMs.....	43
Installing and Removing PCI Express x16 Add-in Cards	43
Installing PCI Express x16 Graphics Cards.....	43
Removing a PCI Express x16 Add-in Card.....	44
Installing Linked PCI Express x16 Graphics Cards.....	45
Connecting the Serial ATA (SATA) Cables	47
Connecting to the Internal Headers	48
Front Panel Audio Header	49
S/PDIF Header	49
IEEE 1394a Header.....	49
Consumer IR (CIR) Headers	50
Chassis Intrusion Header	51
USB 2.0 Headers	51
Alternate Front Panel Power LED Header	52
Front Panel Header	52
Connecting to the Audio System.....	53
Connecting Chassis Fan and Power Supply Cables.....	54
Connecting Chassis Fan Cables	54
Connecting Power Supply Cables	55
Setting the BIOS Configuration Jumper	56
Clearing Passwords	57
Replacing the Battery	58
Installing the WiFi/Bluetooth* Module in a Desktop Chassis.....	63

3 Updating the BIOS

Updating the BIOS with the Intel® Express BIOS Update Utility.....	65
Updating the BIOS Using the F7 Function Key	66
Updating the BIOS with the Intel® Flash Memory Update Utility or the ISO Image BIOS Update File	66
Obtaining the BIOS Update File	66
Updating the BIOS with the Intel Flash Memory Update Utility.....	67
Updating the BIOS with the ISO Image BIOS Update File	67
Recovering the BIOS.....	68

4 Configuring for RAID

Configuring for RAID Using Intel® Matrix Storage Technology	69
Configuring the BIOS	69
Creating Your RAID Set	69
Loading the Intel Matrix Storage Technology RAID Drivers and Software	70
Setting Up a “RAID Ready” System	70
Configuring for External RAID Using Marvell* Storage Technology.....	71
Configuring the BIOS	71
Creating Your RAID Set	71
Loading the Marvell Storage Technology RAID Drivers and Software	71

A Error Messages and Indicators

BIOS Error Codes.....	73
BIOS Error Messages.....	74
Port 80h POST Codes.....	75

B Regulatory Compliance

Safety Standards	79
Battery Caution	79
European Union Declaration of Conformity Statement.....	80
Product Ecology Statements	81
Recycling Considerations	81
China RoHS	84
EMC Regulations	85
FCC Declaration of Conformity.....	85
Canadian Department of Communications Compliance Statement.....	86
Japan VCCI Statement	86
Korea Class B Statement	87
Ensure Electromagnetic Compatibility (EMC) Compliance.....	87
Product Certifications.....	88
Board-Level Certifications	88
Chassis- and Component-Level Certifications	89
ENERGY STAR*, e-Standby, and ErP Compliance	89

Figures

1. Intel Desktop Board DX58S02 Components.....	12
2. LAN Connector LEDs	17
3. Location of the Back to BIOS Button.....	20
4. Location of the Standby Power Indicator	24
5. Onboard System Control Switches	25
6. Location of the Diagnostic/Status LEDs	27
7. Installing the I/O Shield	33
8. Intel Desktop Board DX58S02 Mounting Screw Hole Locations	34
9. Unlatch the Socket Lever.....	35
10. Lift the Load Plate.....	36
11. Remove the Processor from the Protective Processor Cover	37
12. Install the Processor	37
13. Close the Load Plate	38
14. Connecting the Processor Fan Heat Sink Cable to the Processor Fan Header	39
15. Example Configuration Using Three DIMMs.....	40

Intel Desktop Board DX58SO2 Product Guide

16. Example Configuration Using Six DIMMs	40
17. Use DDR3 DIMMs	41
18. Installing a DIMM	42
19. Installing a PCI Express x16 Card	44
20. Removing a PCI Express x16 Card	45
21. Installing Linked PCI Express Graphics Cards.....	46
22. Connecting the Serial ATA Cables.....	47
23. Internal Headers	48
24. Back Panel Audio Connectors	53
25. Location of the Chassis Fan Headers.....	54
26. Connecting Power Supply Cables	55
27. Location of the BIOS Configuration Jumper Block	56
28. Removing the Battery	62
29. Installing the WiFi/Bluetooth Module	64
30. POST Code LED Display	75
31. Intel Desktop Board DX58SO2 China RoHS Material Self Declaration Table.....	84

Tables

1. Feature Summary.....	9
2. Intel Desktop Board DX58SO2 Components.....	13
3. LAN Connector LEDs	18
4. Diagnostic LEDs	28
5. Front Panel Audio Header Signal Names.....	49
6. S/PDIF Header Signal Names	49
7. IEEE 1394a Header Signal Names	49
8. Front Panel CIR Receiver (Input) Header Signal Names.....	50
9. Back Panel CIR Header Emitter (Output) Header Signal Names	50
10. Chassis Intrusion Header Signal Names	51
11. USB 2.0 Header Signal Names.....	51
12. Alternate Front Panel Power LED Header Signal Names	52
13. Front Panel Header Signal Names	52
14. Jumper Settings for the BIOS Setup Program Modes.....	57
15. BIOS Beep Codes	73
16. Front-panel Power LED Blink Codes.....	73
17. BIOS Error Messages	74
18. Port 80h POST Codes	76
19. Safety Standards.....	79
20. EMC Regulations.....	85
21. Regulatory Compliance Marks.....	88

1 Desktop Board Features

This chapter briefly describes the features of Intel® Desktop Board DX58SO2. Table 1 summarizes the major features of the Desktop Board.

Table 1. Feature Summary

Form Factor	ATX (304.80 millimeters [12.00 inches] x 243.84 millimeters [9.60 inches])
Processor	Support for an Intel® processor in the LGA1366 package
Main Memory	<ul style="list-style-type: none"> • Six 240-pin DDR3 SDRAM Dual Inline Memory Module (DIMM) sockets arranged in three channels • Support for DDR3 1600+, DDR3 1333 MHz, DDR3 1066 MHz, and DDR3 800 MHz DIMMs. Speeds over 1600 MHz are supported via XMP profiles • Support for ECC and non-ECC memory • Support for up to 24 GB of system memory
Chipset	Intel® X58 Express Chipset consisting of: <ul style="list-style-type: none"> • Intel X58 Express Chipset I/O Hub (IOH) • Intel® I/O Controller Hub (ICH10R) supporting Intel® Matrix Storage Technology
Graphics	Support for multiple PCI Express* graphics cards including linked cards using Nvidia* SLI* technology and ATI CrossFireX* technology
Audio	<ul style="list-style-type: none"> • Independent multi-streaming 8-channel (7.1) audio and 2-channel audio subsystem, featuring: <ul style="list-style-type: none"> – Intel® High Definition Audio interface – RealTek* ALC892 codec • HD Audio front panel header • Onboard 3-pin S/PDIF header and a back panel optical S/PDIF connector
Expansion Capabilities	<ul style="list-style-type: none"> • Three PCI Express 2.0 x16 ports • Two PCI Express 1.1 x1 ports • One PCI* bus connector
Legacy I/O Support	Legacy I/O Controller that provides Consumer Infrared (CIR) support
Peripheral Interfaces	<ul style="list-style-type: none"> • Up to 12 USB 2.0 ports: <ul style="list-style-type: none"> – Six ports routed to the back panel – Six ports routed to three USB headers • Up to two IEEE 1394a ports: <ul style="list-style-type: none"> – One port routed to the back panel – One port routed to an IEEE 1394a header • Two Serial ATA (SATA) channels (6.0 Gb/s) via a discrete controller • Six Serial ATA (SATA) channels (3.0 Gb/s) via ICH10R • Two external SATA (eSATA) channels via a discrete controller
RAID	<ul style="list-style-type: none"> • Intel® Matrix Storage Technology for Serial ATA

continued

Table 1. Feature Summary (continued)

LAN Support	Gigabit (10/100/1000 Mb/s) dual LAN subsystem using the Intel® 82567L and Intel® 82574L Gigabit Ethernet Controllers
BIOS	<ul style="list-style-type: none"> • Intel® Platform Innovation Framework for extensible firmware interface • 16 Mb symmetrical flash memory device • Support for SMBIOS • Intel® Rapid BIOS Boot • Intel® Express BIOS Update
Power Management	<ul style="list-style-type: none"> • Support for Advanced Configuration and Power Interface (ACPI) • Suspend to RAM (STR) • Wake on USB, PCI, PCI Express, LAN, CIR, and front panel • ENERGY STAR* capable
Hardware Management	<p>Hardware monitor with:</p> <ul style="list-style-type: none"> • Four fan sensing inputs used to monitor fan activity • Intel® Precision Cooling Technology fan speed control • Voltage sensing to detect out of range values

Supported Operating Systems

- Microsoft Windows* 7 Ultimate 64-bit edition
- Microsoft Windows 7 Ultimate 32-bit edition
- Microsoft Windows 7 Professional 64-bit edition
- Microsoft Windows 7 Professional 32-bit edition
- Microsoft Windows 7 Home Premium 64-bit edition
- Microsoft Windows 7 Home Premium 32-bit edition
- Microsoft Windows 7 Starter 64-bit edition
- Microsoft Windows 7 Starter 32-bit edition
- Microsoft Windows Vista* Ultimate 32-bit edition
- Microsoft Windows Vista Business 32-bit edition
- Microsoft Windows Vista Home Premium 32-bit edition
- Microsoft Windows Vista Home Basic 32-bit edition
- Microsoft Windows Vista Ultimate 64-bit edition
- Microsoft Windows Vista Business 64-bit edition
- Microsoft Windows Vista Home Premium 64-bit edition
- Microsoft Windows Vista Home Basic 64-bit edition
- Microsoft Windows* XP Media Center Edition 2005
- Microsoft Windows XP Professional
- Microsoft Windows XP Professional x64 Edition
- Microsoft Windows XP Home

Desktop Board Components

Figure 1 shows the approximate location of the major components on Intel Desktop Board DX58S02.

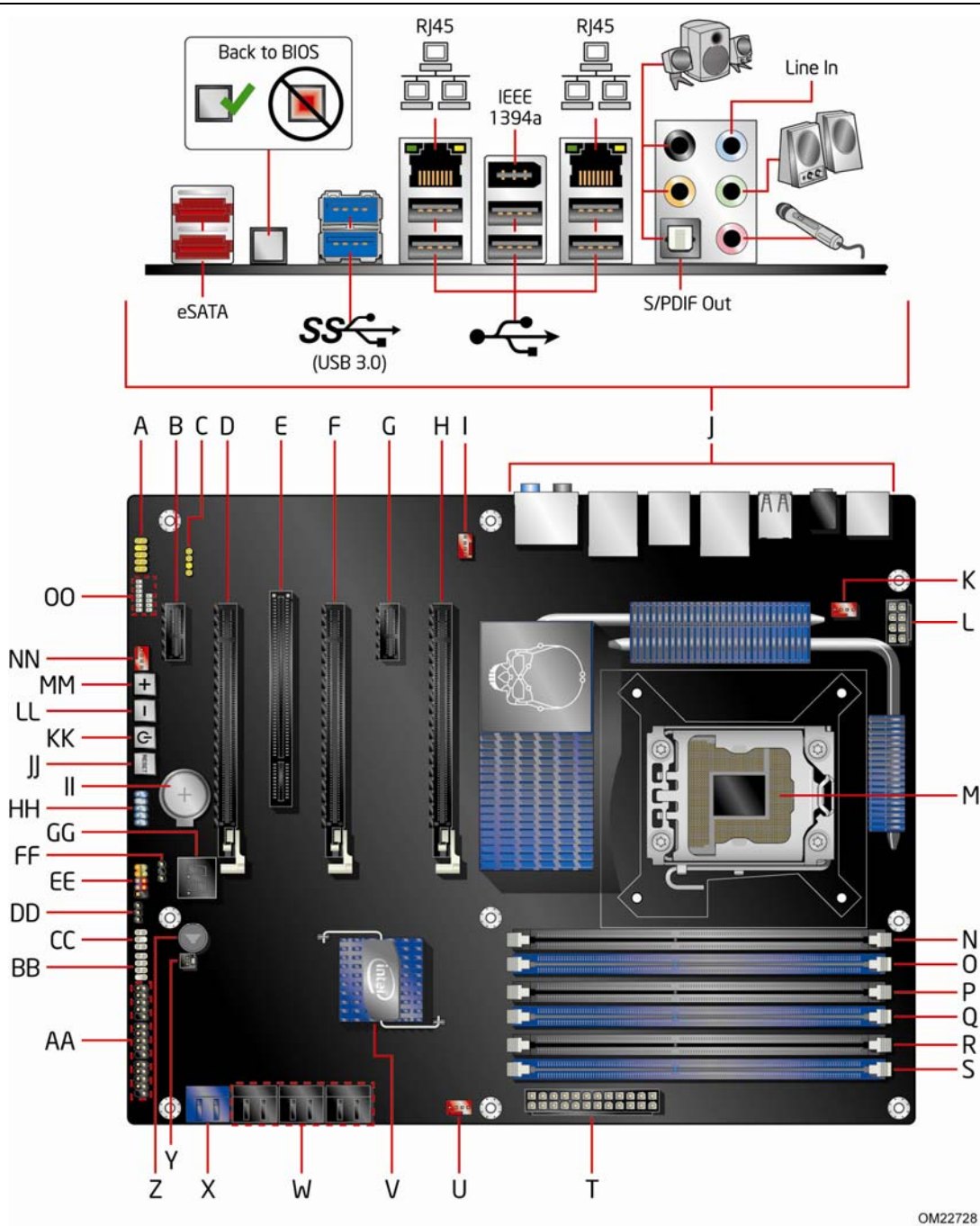

Figure 1. Intel Desktop Board DX58S02 Components

Table 2. Intel Desktop Board DX58S02 Components

Label	Description
A	Front panel audio header
B	PCI Express 1.1 x1 connector
C	S/PDIF header
D	PCI Express 2.0 x16 connector (x8 electrical)
E	PCI bus connector
F	PCI Express 2.0 x16 connector
G	PCI Express 1.1 x1 connector
H	PCI Express 2.0 x16 connector
I	Rear chassis fan header
J	Back panel connectors
K	Processor fan header
L	12 V processor core voltage connector (2 x 4 pin)
M	Processor socket
N	DIMM 4 socket
O	DIMM 1 socket
P	DIMM 5 socket
Q	DIMM 2 socket
R	DIMM 6 socket
S	DIMM 3 socket
T	Main power connector (2 x 12 pin)
U	Front chassis fan header
V	ICH10R
W	Serial ATA connectors (3 Gb/s)
X	Serial ATA connectors (6 Gb/s)
Y	Chassis intrusion header
Z	Speaker
AA	USB 2.0 headers
BB	Front panel CIR receiver (input) header
CC	Back panel CIR transmitter (output) header
DD	BIOS configuration jumper block
EE	Front panel header
FF	Alternate front panel power LED header
GG	POST code LED display
HH	IEEE 1394a header
II	Battery
JJ	Reset button
KK	Power button
LL	Base clock frequency decrease button
MM	Base clock frequency increase button
NN	Auxiliary chassis fan header
OO	Diagnostic/status LEDs

Online Support

For more information on Intel Desktop Board DX58SO2 consult the following online resources:

- Intel Desktop Board DX58SO2 <http://www.intel.com/products/motherboard/index.htm>
- Desktop Board Support http://www.intel.com/p/en_US/support?iid=hdr+support
- Available configurations for Intel Desktop Board DX58SO2 <http://ark.intel.com>
- Supported processors <http://processormatch.intel.com>
- Chipset information <http://www.intel.com/products/desktop/chipsets/index.htm>
- BIOS and driver updates <http://downloadcenter.intel.com/>
- Integration information <http://www.intel.com/support/go/buildit>

Processor



CAUTION

Failure to use an appropriate power supply and/or not connecting the 12 V (2 x 4 pin) power connector to the Desktop Board may result in damage to the board, or the system may not function properly.

Intel Desktop Board DX58SO2 supports an Intel processor in the LGA1366 package. Processors are not included with the Desktop Board and must be purchased separately. The processor connects to the Desktop Board through the LGA1366 socket.

Go to the following page or link for more information about:

- Instructions on installing or upgrading the processor, page 35 in Chapter 2
- Supported processors for Intel Desktop Board DX58SO2, <http://processormatch.intel.com>

Main Memory



NOTE

To be fully compliant with all applicable Intel® SDRAM memory specifications, the board should be populated with DIMMs that support the Serial Presence Detect (SPD) data structure. If your memory modules do not support SPD, you will see a notification to this effect on the screen at power up. The BIOS will attempt to configure the memory controller for normal operation.

The Desktop Board supports the following memory and interface:

- Six 240-pin Double Data Rate 3 (DDR3) SDRAM Dual Inline Memory Module (DIMM) connectors with gold-plated contacts arranged in three channels
- 1600+/1333/1066/800 MHz DDR3 SDRAM Memory Modules



NOTE

DDR3 1600 or higher memory support on this desktop board requires compatible XMP-enabled memory or advanced knowledge of BIOS and manual memory tuning. Individual results may vary.

- Support for single-, dual-, and triple-channel memory interleaving
- Unbuffered, non-registered single or double-sided DIMMs with a voltage rating of 1.65 V or less



NOTE

Using a DIMM with a voltage rating higher than 1.65 V may damage the processor.

- ECC and non-ECC DDR3 memory
- Serial Presence Detect (SPD) memory only
- Up to 24 GB maximum total system memory



NOTE

32-bit operating systems are limited to a maximum of 4 GB of memory. The operating system report less than 4 GB because of the memory used by add-in graphics cards.

Go to the following links or pages for more information about:

- SDRAM specifications, <http://www.intel.com/technology/memory/>
- Installing memory, page 40 in Chapter 2

Intel® X58 Express Chipset

The Intel X58 Express Chipset consists of the following devices:

- Intel X58 Express Chipset I/O Hub (IOH)
- Intel 82801IJR I/O Controller Hub (ICH10R)

The IOH provides interfaces to the processor and the PCI Express bus. ICH10R is the centralized controller for the board's I/O paths.

Go to the following link for more information about the Intel X58 Express Chipset:

<http://developer.intel.com/products/chipsets/index.htm>

Audio Subsystem

The onboard audio subsystem consists of the following components:

- Intel® ICH10R I/O controller hub
- RealTek ALC892 codec

The subsystem has the following headers and connectors:

- Back panel audio connectors, including an S/PDIF optical port
- High Definition (HD) Audio front panel header that provides mic in and line out signals for front panel audio connectors
- S/PDIF header

The audio subsystem supports the following features:

- Dolby* Home Theater
- A signal-to-noise (S/N) ratio of 95 dB
- Independent multi-streaming 8-channel (7.1) audio (using the back panel audio connectors) and 2-channel audio (using the Intel High Definition Audio front panel header)

Go to the following link or pages for more information about:

- The location of the onboard audio headers, Figure 23 on page 48
- The signal names for the Intel High Definition Audio front panel header, page 49
- The back panel audio connectors, Figure 24 on page 53

LAN Subsystem

The Dual Gigabit (10/100/1000 Mb/s) LAN subsystem includes:

- Intel ICH10R
- Intel 82567LF Gigabit Ethernet LAN Controller
- Intel 82574L Gigabit Ethernet LAN Controller
- Two RJ-45 LAN connectors with integrated status LEDs

The subsystem features:

- CSMA/CD protocol engine
- LAN connect interface between ICH10R and the Intel 82567LF Gigabit Ethernet LAN Controller
- PCI bus power management

Go to the following link for information about LAN software and drivers:

<http://www.intel.com/products/motherboard/index.htm>

Two LEDs are built into each RJ-45 LAN connector located on the back panel (see Figure 2). These LEDs indicate the status of the LAN.

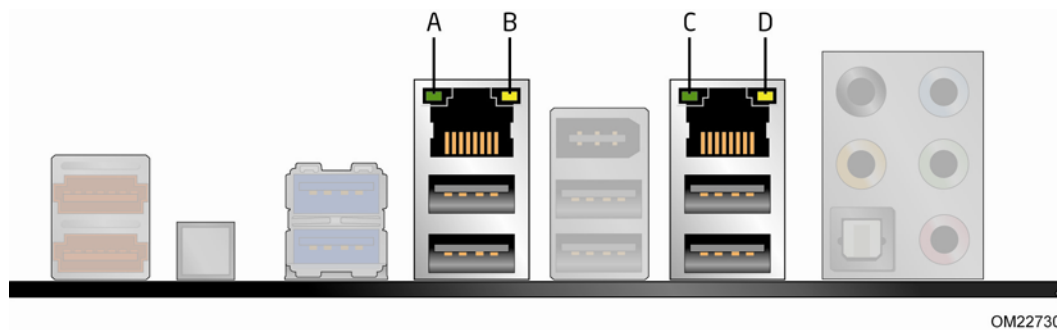

Figure 2. LAN Connector LEDs

Table 3 describes the LED states when the board is powered up and the LAN subsystem is operating.

Table 3. LAN Connector LEDs

LED	LED Color	LED State	Indicates
A	Green	Off	LAN link is not established
		On	LAN link is established
		Blinking	LAN activity is occurring
B	N/A	Off	10 Mb/s data rate
	Green	On	100 Mb/s data rate
	Yellow	On	1000 Mb/s data rate
C	Green	Off	LAN link is not established
		On	LAN link is established
		Blinking	LAN activity is occurring
D	N/A	Off	10 Mb/s data rate
	Green	On	100 Mb/s data rate
	Yellow	On	1000 Mb/s data rate

USB 2.0 Support

The Desktop Board supports USB 3.0 and USB 2.0. USB 3.0 is supported via two USB 3.0 ports (blue) on the back panel. USB 3.0 ports are backward compatible with USB 2.0 and USB 1.1 devices. The USB 3.0 ports are SuperSpeed, high-speed, full-speed, and low-speed capable. USB 3.0 support requires both an operating system and drivers that fully support USB 3.0 transfer rates.

There are 12 USB 2.0 ports (six ports routed to back panel connectors (black) and six ports routed to three onboard headers). The USB 2.0 ports are high-speed, full-speed, and low-speed capable. USB 2.0 support requires both an operating system and drivers that fully support USB 2.0 transfer rates.

Serial ATA

The board provides two onboard 6.0 Gb/s Serial ATA (SATA) channels (blue connectors) and six onboard 3.0 Gb/s SATA channels (black connectors).

The onboard Serial ATA channels provided by ICH10R support the following RAID (Redundant Array of Independent Drives) levels:

- RAID 0 - data striping
- RAID 1 - data mirroring
- RAID 0+1 (or RAID 10) - data striping and data mirroring
- RAID 5 - distributed parity

For information on configuring your system for RAID using Intel® Matrix Storage Technology see Chapter 4.

The board also provides two 3.0 Gb/s external SATA (eSATA) channels via back panel connectors.

Legacy I/O

Intel Desktop Board DX58SO2 includes an I/O controller that provides the following legacy I/O features:

- Consumer Infrared (CIR) support
- Low pin count (LPC) interface
- Intelligent power management, including a programmable wake up event interface
- PCI power management support

Expandability

Intel Desktop Board DX58SO2 provides the following expansion capability:

- Three PCI Express 2.0 x16 ports
- Two PCI Express 1.1 x1 ports
- One PCI bus connector

BIOS

The BIOS provides the Power-On Self-Test (POST), the BIOS Setup program, and the PCI/PCI Express and IDE auto-configuration utilities. The BIOS is stored in the Serial Peripheral Interface (SPI) Flash device.

The BIOS can be updated by following the instructions on page 65 in Chapter 3.

Serial ATA and IDE Auto Configuration

If you install a Serial ATA or IDE device (such as a hard drive) in your computer, the auto-configuration utility in the BIOS automatically detects and configures the device for your computer. You do not need to run the BIOS Setup program after installing a Serial ATA or IDE device. You can override the auto-configuration options by specifying manual configuration in the BIOS Setup program.

PCI and PCI Express* Auto Configuration

If you install a PCI/PCI Express add-in card in your computer, the PCI/PCI Express auto-configuration utility in the BIOS automatically detects and configures the resources (IRQs, DMA channels, and I/O space) for that add-in card. You do not need to run the BIOS Setup program after you install a PCI/PCI Express add-in card.

Security Passwords

The BIOS includes security features that restrict whether the BIOS Setup program can be accessed and who can boot the computer. A supervisor password and a user password can be set for the BIOS Setup and for booting the computer, with the following restrictions:

- The supervisor password gives unrestricted access to view and change all Setup options. If only the supervisor password is set, pressing <Enter> at the password prompt of Setup gives the user restricted access to Setup.
- If both the supervisor and user passwords are set, you must enter either the supervisor password or the user password to access Setup. Setup options are then available for viewing and changing depending on whether the supervisor or user password was entered.
- Setting a user password restricts who can boot the computer. The password prompt is displayed before the computer is booted. If only the supervisor password is set, the computer boots without asking for a password. If both passwords are set, you can enter either password to boot the computer.

For instructions on resetting the password, go to Clearing Passwords on page 57.

Back to BIOS Button

The back panel Back to BIOS button (Figure 3, A) duplicates the functionality of the BIOS configuration jumper with the following exceptions:

- It can only be used to force the board to power on to the BIOS Maintenance Menu using default values but it will retain all previously saved changes.
- It cannot be used to override passwords set in the BIOS.
- It cannot be used to invoke BIOS recovery mode.

The button glows red when it is activated.



NOTE

Using the Back to BIOS button does not set the board to the factory BIOS defaults. To restore settings to the factory defaults, use the <F9> key once BIOS setup mode is active.

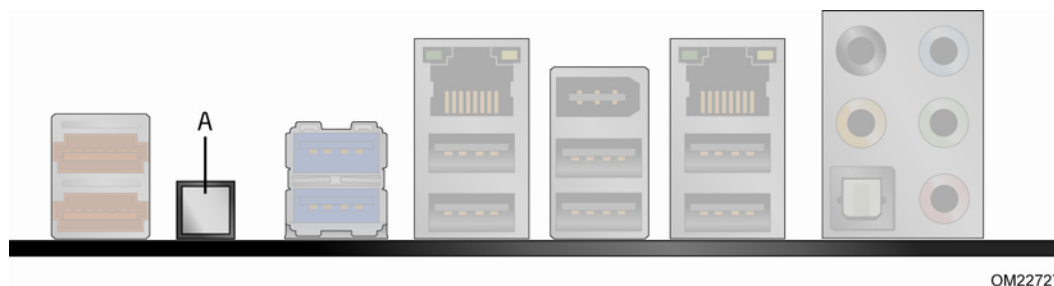

Figure 3. Location of the Back to BIOS Button

Hardware Management

The hardware management features of Intel Desktop Board DX58SO2 enable the board to be compatible with the Wired for Management (WfM) specification. The board has several hardware management features including the following:

- Fan speed monitoring and control
- Thermal and voltage monitoring
- Chassis intrusion detection

Hardware Monitoring and Fan Speed Control

The features of the hardware monitoring and fan speed control include:

- Monitoring of power supply voltages to detect levels above and below acceptable values
- Intel® Precision Cooling Technology fan speed control, delivering acoustically-optimized thermal management
- A thermal sensor in the processor
- Thermally monitored closed-loop fan control, for all onboard fans, that can adjust fan speed

Intel® Precision Cooling Technology

Intel Precision Cooling Technology automatically adjusts processor fan speed based on the processor temperature and adjusts chassis fan speeds based on the internal system temperature.

Chassis Intrusion

The board supports a chassis security feature that detects if the chassis cover has been removed. The security feature uses a mechanical switch on the chassis that can be connected to the chassis intrusion header on the Desktop Board. See Figure 23 for the location of the chassis intrusion header.

Power Management

Power management is implemented at several levels, including software support through the Advanced Configuration and Power Interface (ACPI) and the following hardware support:

- Power connectors
- Fan headers
- LAN wake capabilities
- Instantly Available PC technology (Suspend to RAM)
- +5 V standby power indicator LED
- Wake from USB
- Power Management Event signal (PME#) wakeup support
- WAKE# signal wake-up support
- Wake from Consumer IR

Software Support

ACPI

ACPI gives the operating system direct control over the power management and Plug and Play functions of a computer. The use of ACPI with the Desktop Board requires an operating system that provides full ACPI support.

Hardware Support

Power Connectors

ATX12V-compliant power supplies can turn off the computer power through system control. When an ACPI-enabled computer receives the correct command, the power supply removes all non-standby voltages.

When resuming from an AC power failure, the computer returns to the power state it was in before power was interrupted (either on or off). The computer's response can be set by using the Last Power State feature in the BIOS Setup program's Boot menu.

The Desktop Board has three power connectors. See Figure 26 on page 55 for the location of the power connectors.

Fan Headers

The function/operation of the fans is as follows:

- The fans are on when the computer is in the ACPI S0 state.
- The fans are off when the computer is in the ACPI S3, S4, or S5 state.
- Each fan header is wired to a tachometer input of the hardware monitoring and control device.
- All fan headers support closed-loop fan control that can adjust the fan speed or switch the fan on or off as needed.
- All fan headers have a +12 V DC connection.

The Desktop Board has a 4-pin processor fan header and three 4-pin chassis fan headers.

LAN Wake Capabilities



CAUTION

For LAN wake capabilities, the 5 V standby line for the power supply must be capable of delivering adequate +5 V standby current. Failure to provide adequate standby current when using this feature can damage the power supply.

LAN wakeup capabilities enable remote wake-up of the computer through a network. The LAN subsystem monitors network traffic and upon detecting a Magic Packet* frame, it asserts a wake-up signal that powers up the computer.

Instantly Available PC Technology



CAUTIONS

For Instantly Available PC technology, the 5 V standby line for the power supply must be capable of delivering adequate +5 V standby current. Failure to provide adequate standby current when using this feature can damage the power supply and/or effect ACPI S3 sleep state functionality.

Power supplies used with this Desktop Board must be able to provide enough standby current to support the standard Instantly Available (ACPI S3 sleep state) configuration. If the standby current necessary to support multiple wake events from the PCI and/or USB buses exceeds power supply capacity, the Desktop Board may lose register settings stored in memory.

Instantly Available PC technology enables the board to enter the ACPI S3 (Suspend-to-RAM) sleep state. While in the S3 sleep state, the computer will appear to be off. If the computer has a dual-colored power LED on the front panel, the sleep state is indicated by the LED turning amber. When signaled by a wake-up device or event, the computer quickly returns to its last known awake state.

The Desktop Board supports the *PCI Bus Power Management Interface Specification*. Add-in cards that support this specification can participate in power management and can be used to wake the computer.

+5 V Standby Power Indicator



CAUTION

If the AC power has been switched off and the standby power indicator is still lit, disconnect the power cord before installing or removing any devices connected to the board. Failure to do so could damage the board and any attached devices.

The Desktop Board's standby power indicator, shown in Figure 4, is lit when there is standby power still present on the board even when the computer appears to be off. For example, when this LED is lit, standby power is still present at the memory module sockets and the PCI bus connectors.

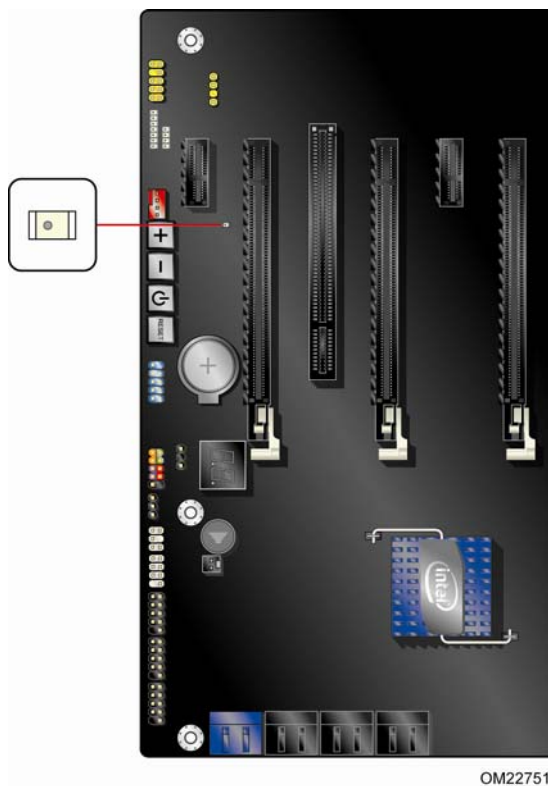

Figure 4. Location of the Standby Power Indicator

For more information on standby current requirements for the Desktop Board, refer to the Technical Product Specification at <http://www.intel.com/products/motherboard/index.htm>

Wake from USB



NOTE

Wake from USB requires the use of a USB peripheral that supports Wake from USB and an operating system that supports Wake from USB.

USB bus activity wakes the computer from an ACPI S3 state.

PME# Signal Wake-up Support

When the PME# signal on the PCI bus is asserted, the computer wakes from an ACPI S1, S3, S4, or S5 state.

WAKE# Signal Wake-up Support

When the WAKE# signal on the PCI Express bus is asserted, the computer wakes from an ACPI S1, S3, S4, or S5 state.

Wake from Consumer IR

Consumer IR device activity wakes the computer from an ACPI S3, S4, or S5 state.

Onboard System Control Switches

The board contains the following lighted button switches that can be used to control board operation:

- Base Clock Frequency Increase
- Base Clock Frequency Decrease
- Power
- Reset

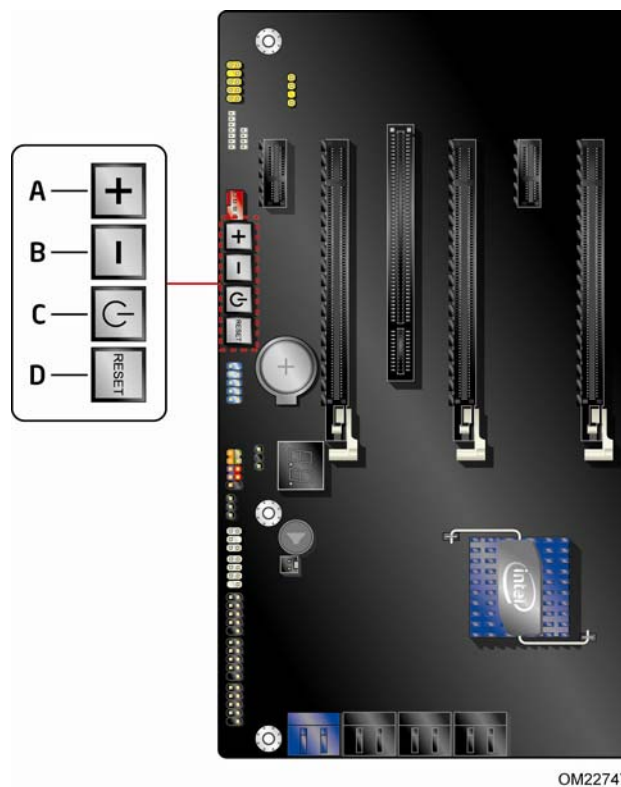

Figure 5. Onboard System Control Switches

Base Clock Frequency Increase Switch

This button switch can be used to overclock the board by increasing the processor's Base Clock (BCLK) frequency by 1 MHz each time the switch is pressed. If the button is held down for approximately 0.5 seconds, the BCLK frequency will continue to increase by 1-MHz steps approximately once every 0.1 second.

The BCLK frequency is used to set the frequencies of all major functional parts of the system. Among them are processor frequency, the Uncore Clock (UCLK), the memory frequency, and the frequency of the QPI interface

Base Clock Frequency Decrease Switch

This button switch can be used during overclocking to decrease the system's Base Clock (BCLK) frequency by 1 MHz each time the switch is pressed. If the button is held down for approximately 0.5 seconds, the BCLK frequency will continue to decrease by 1-MHz steps approximately once every 0.1 second.

Power Switch

The power button switch (see Figure 5, C) can be used to turn the desktop board on or off. This power button switch behaves the same as a chassis power switch connected via the front panel header. The onboard power button switch does not remove standby power. To turn off the computer using the onboard power button switch, keep it pressed down for three seconds.

Reset Switch

The reset button switch (see Figure 5, D) can be used to reset the desktop board. This power button switch behaves the same as a chassis reset switch connected via the front panel header. When the reset button switch is pressed, the board resets and runs the POST.

Diagnostic/Status LEDs

The Desktop Board provides 11 LEDs that allow you to monitor the board's progress through the BIOS POST along with other board activities and conditions (see Figure 6).

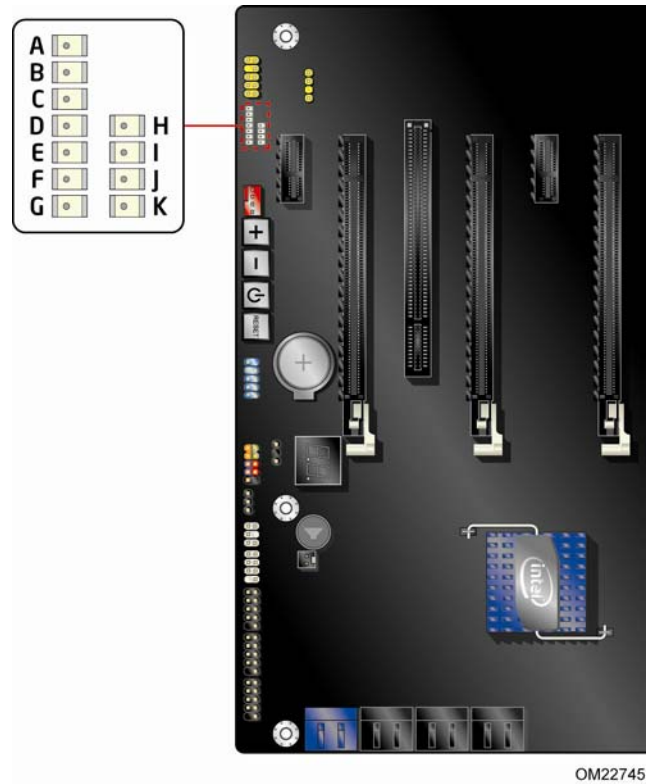

Figure 6. Location of the Diagnostic/Status LEDs

Diagnostic LEDs

At initial power on, the eight diagnostic LEDs are off. When the BIOS starts an activity such as memory initialization, the corresponding LED starts flashing. Once the activity has completed, the LED will remain on. Table 4 lists the LEDs and describes their function.

Table 4. Diagnostic LEDs

Activity	Item/Callout in Figure 6	LED Color	Description
Watch Dog Timer Fire/ Back to BIOS	K	Red	When the watch dog timer fires to reset the board, this LED will flash. In addition, this LED will light and stay on when the Back to BIOS button has been pressed.
Processor Initialization	G	Green	This LED will flash when the processor initialization activity starts. Then the LED will stay on when processor initialization is complete.
Memory Initialization	F	Green	This LED will flash when the memory initialization activity starts. Then the LED will stay on when memory initialization is complete.
Video Initialization	E	Green	This LED will flash when the video initialization activity starts. Then the LED will stay on when video initialization is complete.
USB Initialization	C	Green	This LED will flash when the USB initialization activity starts. Then the LED will stay on when USB initialization is complete.
Mass Storage Initialization	B	Green	This LED will flash when the hard drive activity starts. Then the LED will stay on when hard drive initialization is complete.
Option ROM Initialization	D	Green	This LED will flash when the option ROM activity starts. Then the LED will stay on when option ROM initialization is complete.
OS Start	A	Green	Just before BIOS transfers control to the operating system, this LED will light and stay on.

CPU and VR Hot LEDs

The following red LEDs (see Figure 6) indicate the status of the processor and the board's voltage regulation circuitry:

- The CPU LED (Figure 6, I) indicates an elevated temperature on the processor that could affect performance.
- The VR LED (Figure 6, J) indicates an elevated temperature in the processor voltage regulator circuit that could affect performance.

SATA Drive Activity LED

The blue Mass Storage LED (Figure 6, H) indicates activity of hard drives connected to the IOH and either of the discrete SATA controllers on the board.

Speaker

A speaker is mounted on the Desktop Board. The speaker provides audible error code (beep code) information during the Power-On Self-Test (POST). Refer to Appendix A for a description of the board's beep codes.

Battery

A battery on the Desktop Board keeps the values in CMOS RAM and the clock current when the computer is turned off and disconnected from AC power. Go to page 58 for instructions on how to replace the battery.

Real-Time Clock

The Desktop Board has a time-of-day clock and 100-year calendar. The battery on the Desktop Board keeps the clock current when the computer is turned off.

2 Installing and Replacing Desktop Board Components

This chapter tells you how to:

- Install the I/O shield
- Install and remove the Desktop Board
- Install and remove a processor
- Install and remove memory
- Install and remove a PCI Express x16 card
- Connect the Serial ATA cables
- Connect to the internal headers and connectors
- Connect to the audio system
- Connect chassis fan and power supply cables
- Set the BIOS configuration jumper
- Clear passwords
- Replace the battery
- Install the WiFi/BlueTooth Module

Before You Begin



CAUTIONS

The procedures in this chapter assume familiarity with the general terminology associated with personal computers and with the safety practices and regulatory compliance required for using and modifying electronic equipment.

Disconnect the computer from its power source and from any telecommunications links, networks, or modems before performing any of the procedures described in this chapter. Failure to disconnect power, telecommunications links, networks, or modems before you open the computer or perform any procedures can result in personal injury or equipment damage. Some circuitry on the board can continue to operate even though the front panel power button is off.

Follow these guidelines before you begin:

- Always follow the steps in each procedure in the correct order.
- Set up a log to record information about your computer, such as model, serial numbers, installed options, and configuration information.
- Electrostatic discharge (ESD) can damage components. Perform the procedures described in this chapter only at an ESD workstation using an antistatic wrist strap and a conductive foam pad. If such a station is not available, you can provide some ESD protection by wearing an antistatic wrist strap and attaching it to a metal part of the computer chassis.

Installation Precautions

When you install and test the Intel Desktop Board, observe all warnings and cautions in the installation instructions.

To avoid injury, be careful of:

- Sharp pins on connectors
- Sharp pins on printed circuit assemblies
- Rough edges and sharp corners on the chassis
- Hot components (such as processors, voltage regulators, and heat sinks)
- Damage to wires that could cause a short circuit

Observe all warnings and cautions that instruct you to refer computer servicing to qualified technical personnel.

Prevent Power Supply Overload

Do not overload the power supply output. To avoid overloading the power supply, make sure that the calculated total current loads of all the modules within the computer is less than the output current rating of each of the power supplies output circuits.

Observe Safety and Regulatory Requirements

Read and follow the instructions in this section and the instructions supplied with the chassis and associated modules. If you do not follow these instructions and the instructions provided by the chassis and module suppliers, you increase your safety risk and the possibility of noncompliance with regional laws and regulations. If the instructions for the chassis are inconsistent with these instructions or the instructions for associated modules, contact the supplier to find out how you can ensure that your computer meets safety and regulatory requirements.

For information about the Desktop Board's regulatory compliance, refer to Appendix B.

Installing the I/O Shield

The Desktop Board comes with an I/O shield. When installed in the chassis, the shield blocks radio frequency transmissions, protects internal components from dust and foreign objects, and promotes correct airflow within the chassis.

Install the I/O shield before installing the Desktop Board in the chassis. Place the shield inside the chassis as shown in Figure 7. Press the shield into place so that it fits tightly and securely. If the shield does not fit, obtain a properly sized shield from the chassis supplier.

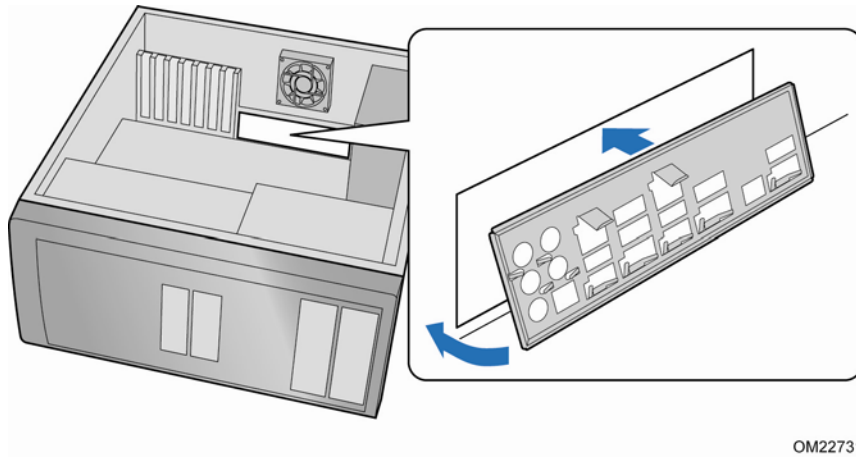

OM22731

Figure 7. Installing the I/O Shield

Installing and Removing the Desktop Board



CAUTION

Only qualified technical personnel should perform this procedure. Disconnect the computer from its power source before performing the procedures described here. Failure to disconnect the power before you open the computer can result in personal injury or equipment damage.

Refer to your chassis manual for instructions on installing and removing the Desktop Board.

Figure 8 shows the location of the mounting screw holes for Intel Desktop Board DX58S02.

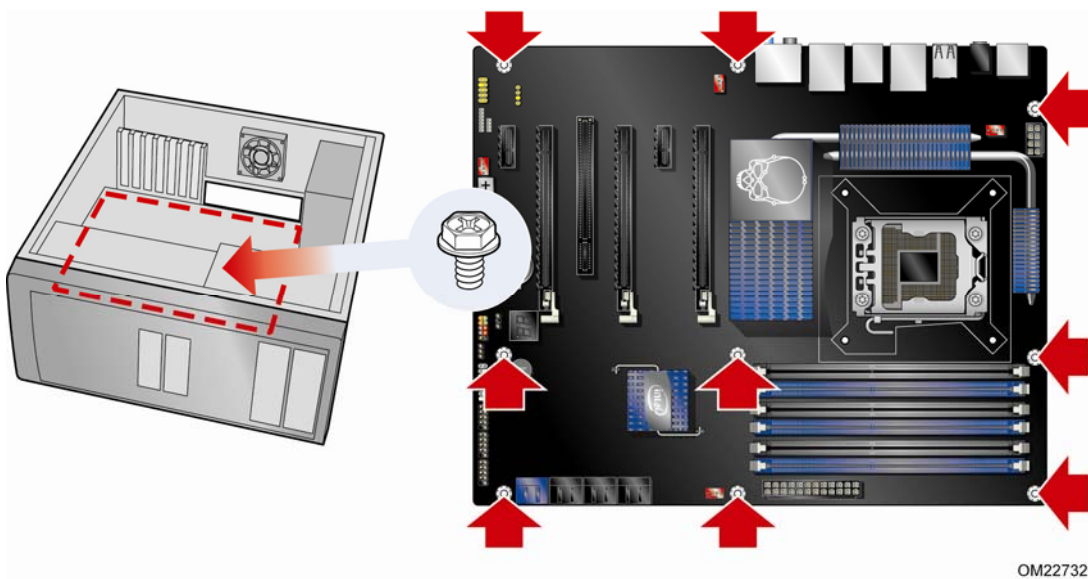

Figure 8. Intel Desktop Board DX58S02 Mounting Screw Hole Locations

Installing and Removing a Processor

Instructions on how to install the processor on the Desktop Board are given below.

Installing a Processor



CAUTION

Before installing or removing a processor, make sure the AC power has been removed by unplugging the power cord from the computer; the standby power LED should not be lit (see Figure 4 on page 24). Failure to do so could damage the processor and the board.

To install a processor, follow these instructions:

1. Observe the precautions in "Before You Begin" on page 31.
2. Open the socket lever by pushing the lever down and away from the socket (Figure 9, A and B).

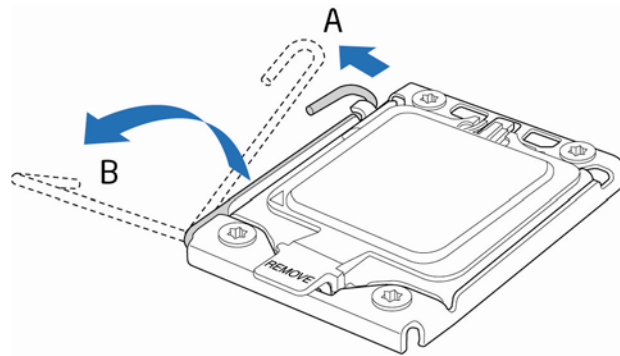

OM22765

Figure 9. Unlatch the Socket Lever

3. Lift the load plate as shown in Figure 10, A. Do not touch the socket contacts.

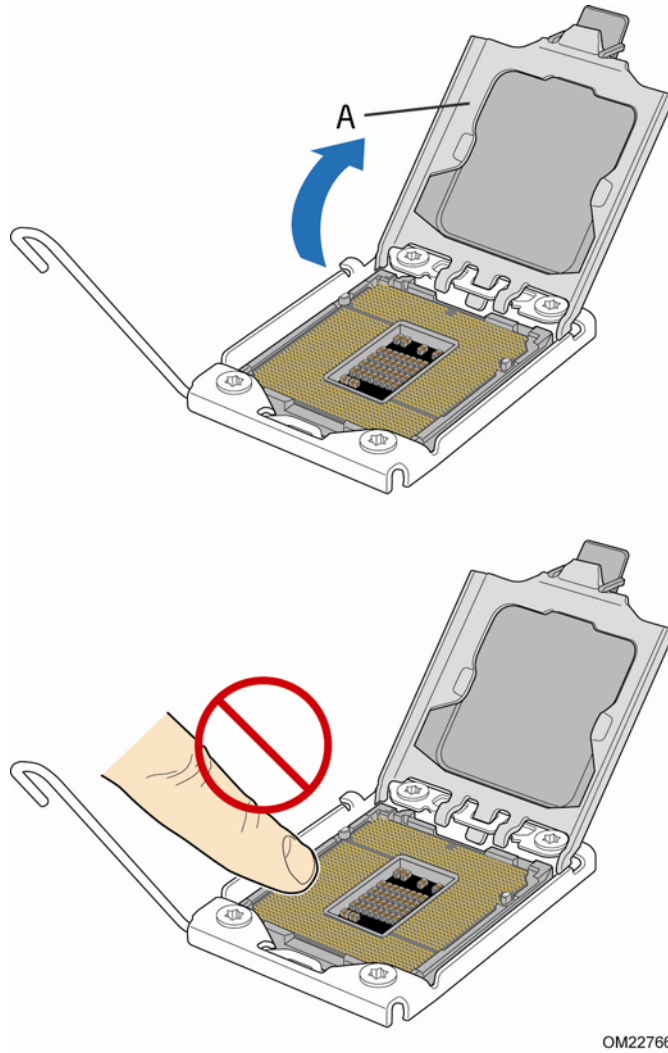

OM22766

Figure 10. Lift the Load Plate

4. Remove the processor from the protective processor cover. Hold the processor only at the edges, being careful not to touch the bottom of the processor (see Figure 11). Do not discard the protective processor cover. Always replace the processor cover if the processor is removed from the socket.

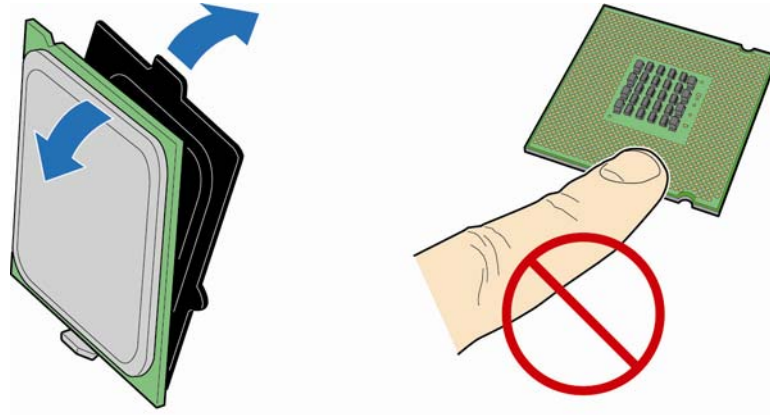

OM22767

Figure 11. Remove the Processor from the Protective Processor Cover

5. Hold the processor with your thumb and index finger oriented as shown in Figure 12. Make sure your fingers align to the socket cutouts (Figure 12, A). Align notches (Figure 12, B) with the posts on the socket (Figure 12, C). Lower the processor straight down without tilting or sliding it in the socket.

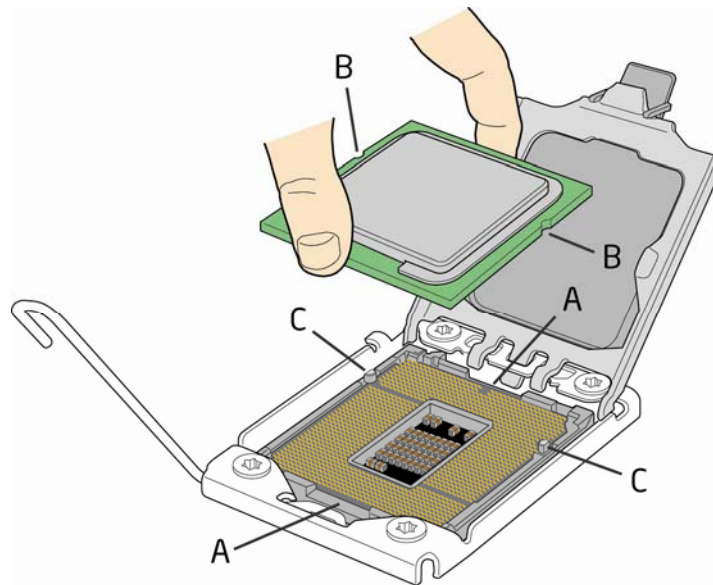

OM22768

Figure 12. Install the Processor

7. Close the load plate (Figure 13, A, B). As the load plate is closed, the socket cover (Figure 13, C) will pop off as shown. After the load plate is closed, engage the socket lever (Figure 13, D) under the latch.

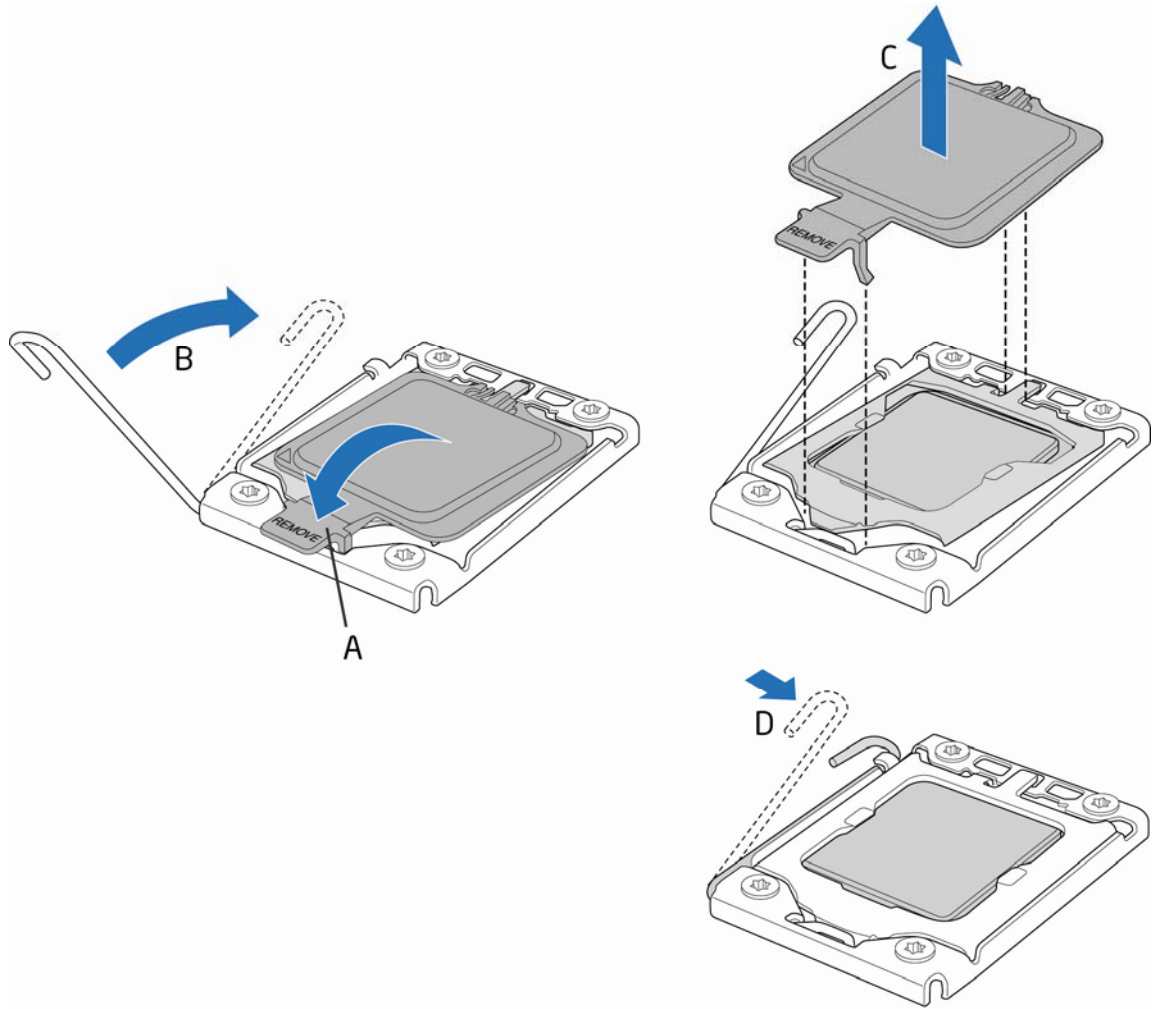

OM22769

Figure 13. Close the Load Plate

8. Pick up the socket cover (Figure 13, C) and remove it from the board.



NOTE

Do not discard the socket cover; save it for possible future use. Always replace the socket cover if you remove the processor from the socket.

Installing the Processor Fan Heat Sink

Intel Desktop Board DX58SO2 has mounting holes for a processor fan heat sink. For instructions on how to attach the processor fan heat sink to the Desktop Board, refer to the boxed processor manual or boxed thermal solution manual.

Connecting the Processor Fan Heat Sink Cable

Connect the processor fan heat sink cable to the 4-pin processor fan header (see Figure 14). A fan with a 4-pin connector as shown in Figure 14, A is recommended; however, a fan with a 3-pin connector (Figure 14, B) can be used. However, since the fan with a 3-pin connector cannot use the onboard fan control, the fan will always operate at full speed.

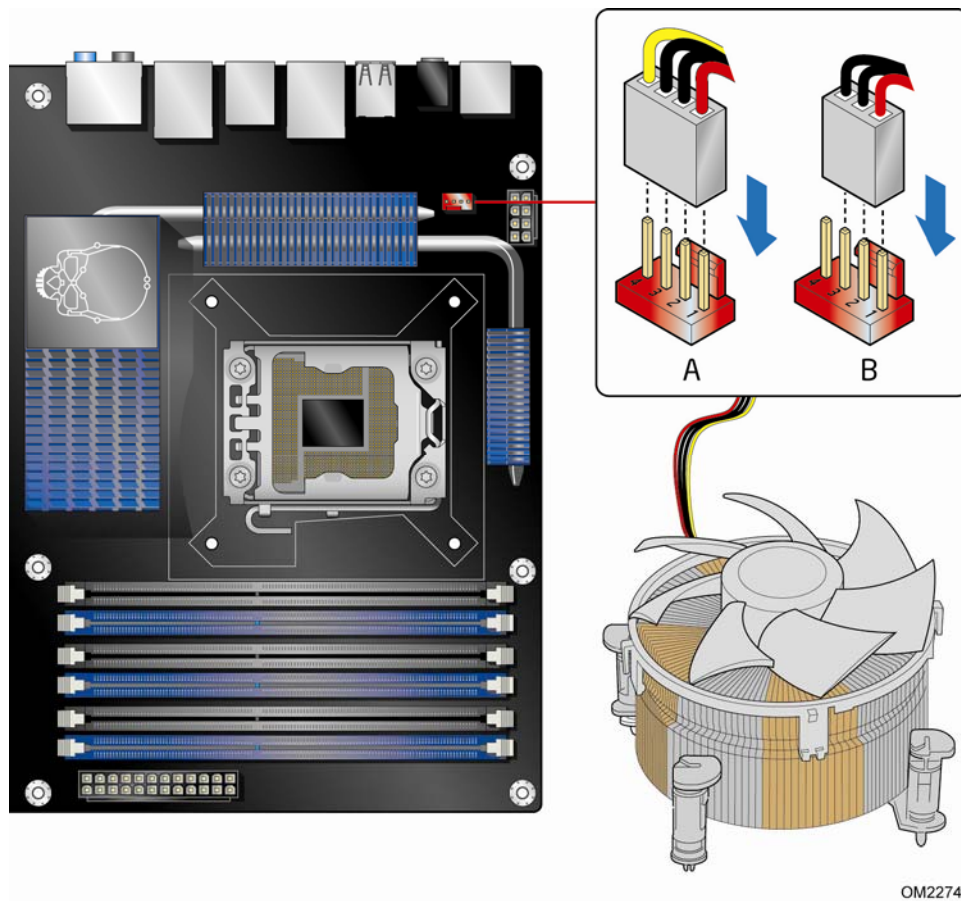

Figure 14. Connecting the Processor Fan Heat Sink Cable to the Processor Fan Header

Removing the Processor

For instructions on how to remove the processor fan heat sink and processor, refer to the processor installation manual.

Installing and Removing Memory

Intel Desktop board DX58SO2 has six 240-pin DDR3 DIMM sockets arranged in three channels (A, B, and C). Each channel has two sockets as shown in the following illustrations.

Optimal memory performance can be achieved by installing matched DIMMS of equal speed and size in each channel. Figure 15 and Figure 16 show two examples of memory configured for triple channel operation.



Figure 15. Example Configuration Using Three DIMMs

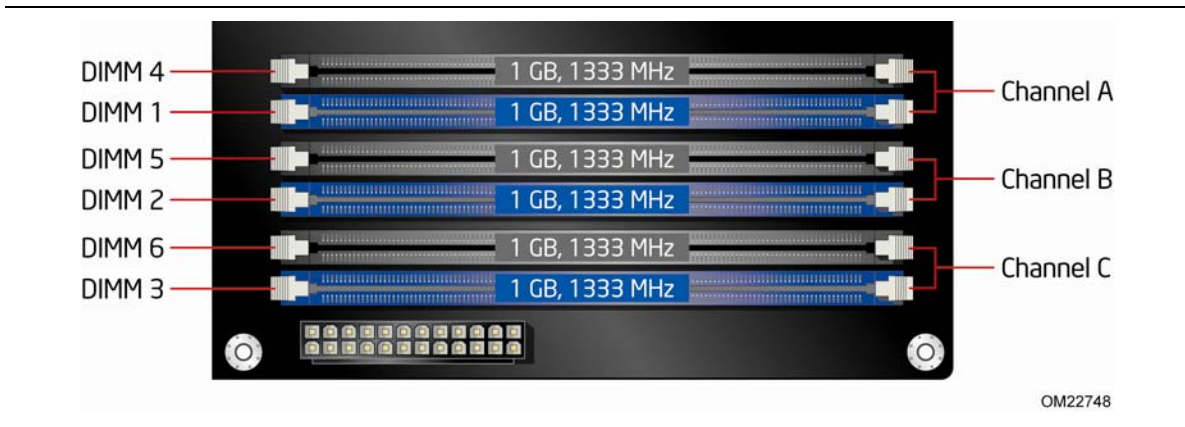

Figure 16. Example Configuration Using Six DIMMs

Installing DIMMs

To make sure you have the correct DIMM, place it on the illustration of the DDR3 DIMM in Figure 17. All the notches should match with the DDR3 DIMM.

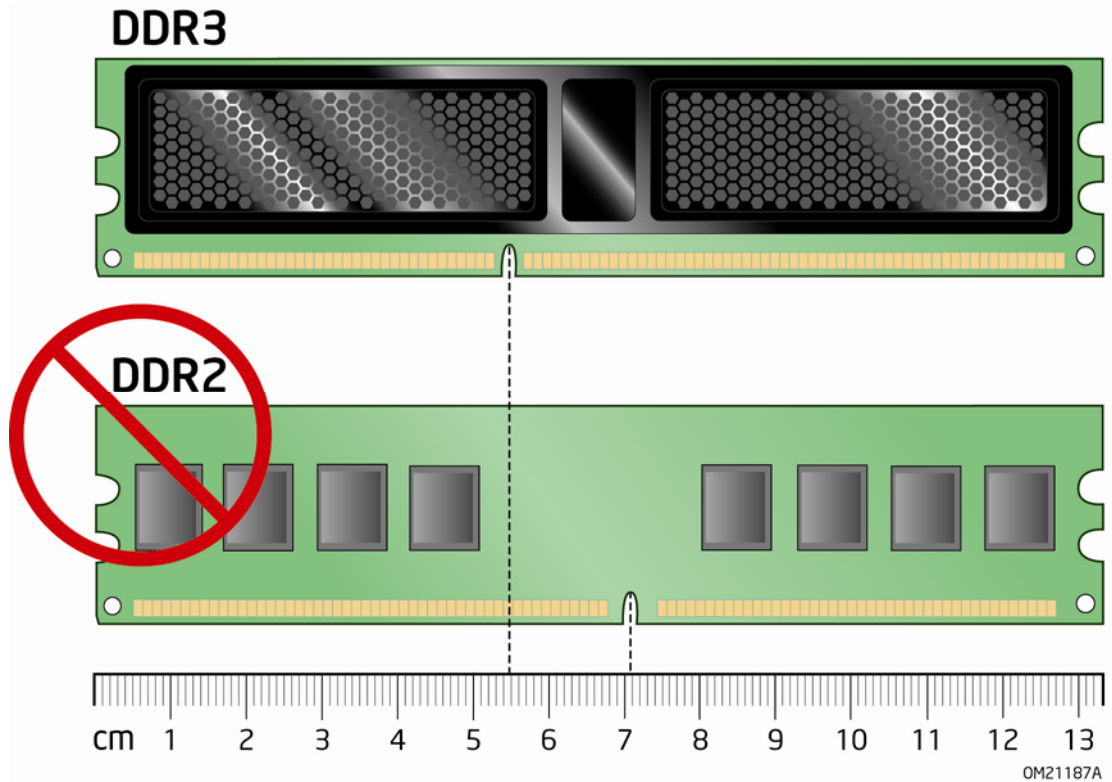

Figure 17. Use DDR3 DIMMs



NOTE

Using a DIMM with a voltage rating higher than 1.65 V may damage the processor.

To install a DIMM, follow these steps:

1. Observe the precautions in "Before You Begin" on page 31.
2. Turn off all peripheral devices connected to the computer. Turn off the computer and disconnect the AC power cord.
3. Remove the computer's cover and locate the DIMM sockets (see Figure 18).

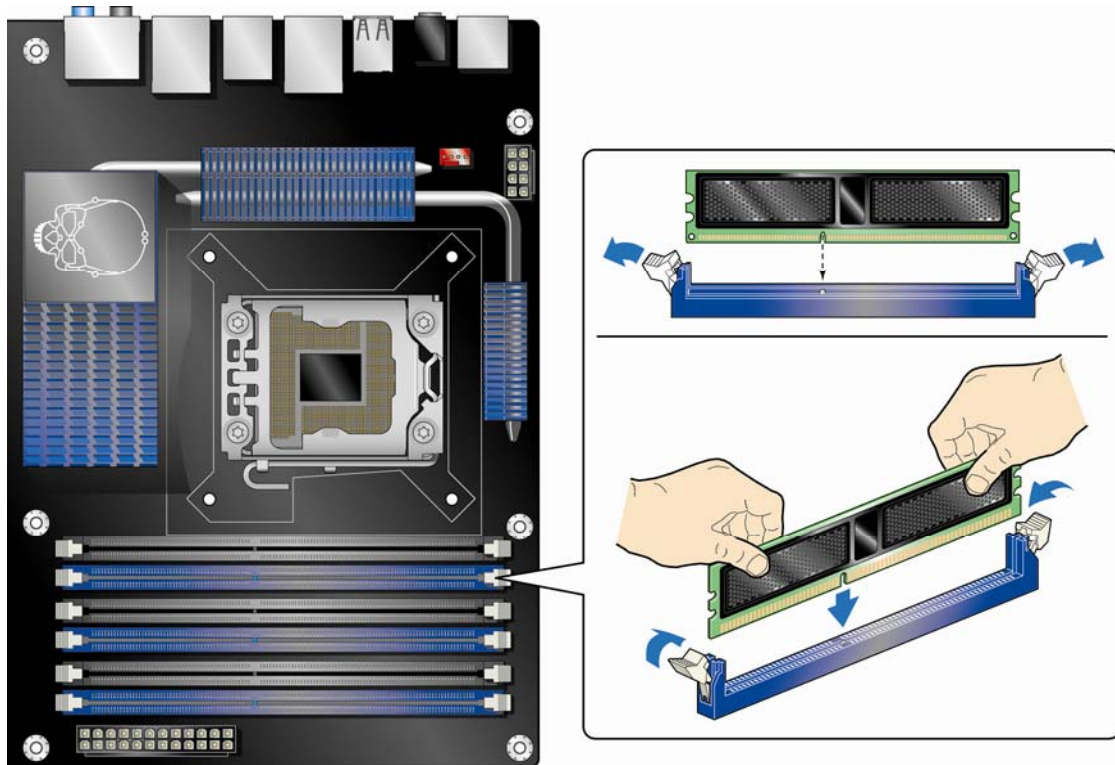

OM22734

Figure 18. Installing a DIMM

4. Make sure the clips at either end of the DIMM socket(s) are pushed outward to the open position.
5. Holding the DIMM by the edges, remove it from its anti-static package.
6. Position the DIMM above the socket. Align the small notch at the bottom edge of the DIMM with the keys in the socket (see inset in Figure 18).
7. Insert the bottom edge of the DIMM into the socket.
8. When the DIMM is inserted, push down on the top edge of the DIMM until the retaining clips snap into place. Make sure the clips are firmly in place.
9. Replace the computer's cover and reconnect the AC power cord.

Removing DIMMs

To remove a DIMM, follow these steps:

1. Observe the precautions in "Before You Begin" on page 31.
2. Turn off all peripheral devices connected to the computer. Turn off the computer.
3. Remove the AC power cord from the computer.
4. Remove the computer's cover.
5. Gently spread the retaining clips at each end of the DIMM socket. The DIMM pops out of the socket.
6. Hold the DIMM by the edges, lift it away from the socket, and store it in an anti-static package.
7. Reinstall and reconnect any parts you removed or disconnected to reach the DIMM sockets.
8. Replace the computer's cover and reconnect the AC power cord.

Installing and Removing PCI Express x16 Add-in Cards



CAUTION

When installing a PCI Express card on the Desktop Board, ensure that the card is fully seated in the PCI Express connector before you power on the system. If the card is not fully seated in the connector, an electrical short may result across the connector pins. Depending on the over-current protection of the power supply, certain Desktop Board components and/or traces may be damaged.

Installing PCI Express x16 Graphics Cards

If you are installing a single PCI Express x16 graphics card, install it in the PCI Express primary connector (Figure 19, A) for optimum performance.

Follow these instructions to install a PCI Express x16 card:

1. Observe the precautions in "Before You Begin" on page 31.
2. Place the card in a PCI Express x16 connector (Figure 19, A) and press down on the card until it is completely seated in the connector and the card retention notch on the card snaps into place around the retention mechanism pin on the connector.
3. Secure the card's metal bracket to the chassis back panel with a screw (Figure 19, B).

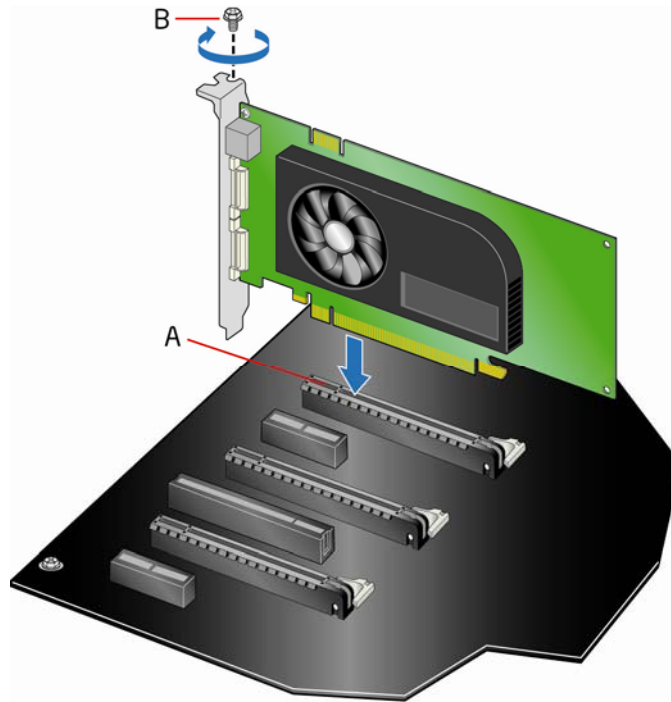

OM22735

Figure 19. Installing a PCI Express x16 Card

Removing a PCI Express x16 Add-in Card

Follow these instructions to remove a PCI Express x16 card from a connector:

1. Observe the precautions in "Before You Begin" on page 31.
2. Remove the screw (Figure 20, A) that secures the card's metal bracket to the chassis back panel.
3. Push the card ejector lever down using the tip of a pencil or similar tool (Figure 20, B) in the notch. This will release the card from the connector (C).
4. Pull the card straight up.

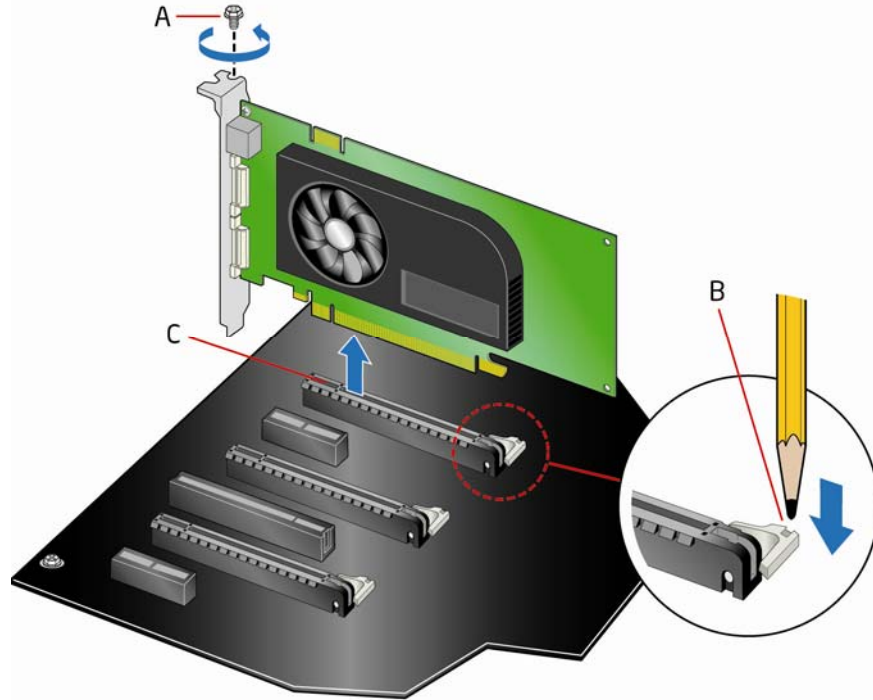

OM22737

Figure 20. Removing a PCI Express x16 Card

Installing Linked PCI Express x16 Graphics Cards

The Desktop Board supports the use of linked PCI Express x16 graphics cards with Nvidia* SLI* technology and ATI* CrossFireX* technology.

When installing linked graphics cards in the PCI Express x16 connectors, refer to the card manufacturer's instructions to determine correct card placement and interconnection. Use the connectors included with the Desktop Board to connect the graphics cards together.



NOTE

The installations steps that follow provide general instructions, for more complete installation and configuration information refer to the documentation supplied by the graphics card manufacturer or visit their website.

To install two linked PCI Express graphics cards:

1. Observe the precautions in "Before You Begin" on page 31.
2. Install the first card in the PCI Express x16 connector as described in "Installing PCI Express x16 Graphics Cards" on page 43.

3. Place the second card in the secondary PCI Express x16 connector (Figure 21, A) and press down on the card until it is completely seated in the connector and the card retention notch on the card snaps into place around the retention mechanism pin on the connector.
4. Secure the card's metal bracket to the chassis back panel with a screw (Figure 21, B).
5. Connect the two cards together with the SLI bridge (Figure 21, C) as shown.
6. Connect the monitor cable to the graphics card according to the manufacturer's instructions.

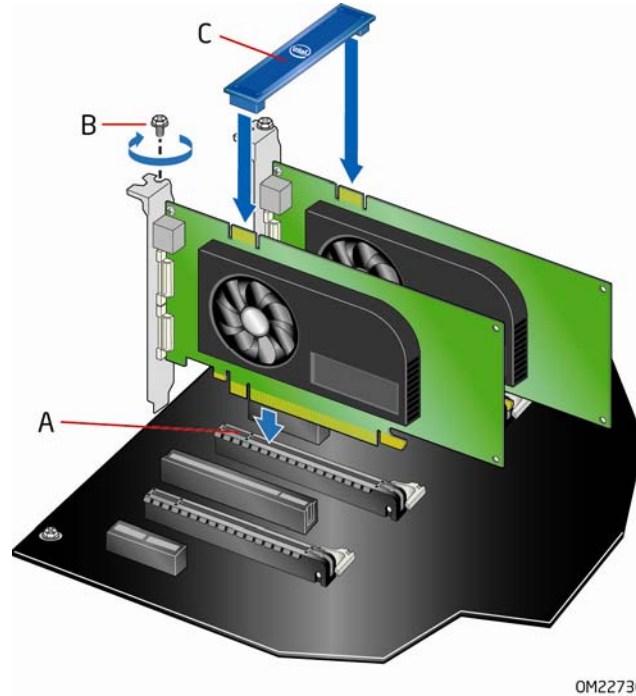

Figure 21. Installing Linked PCI Express Graphics Cards

For more complete installation and configuration information refer to the documentation supplied by the graphics card manufacturer or visit their website.

Connecting the Serial ATA (SATA) Cables

SATA cables support the Serial ATA protocol. Each cable can be used to connect one internal SATA drive to the Desktop Board. The blue connectors support SATA 6 Gb/s and lower transfer rates and the black connectors support SATA 3 Gb/s and lower transfer rates. For correct cable function:

1. Observe the precaution in "Before You Begin" on page 31.
2. Attach one end of the SATA cable to one of the SATA connectors on the board (Figure 22, A) and attach the other end of the cable to the SATA drive (Figure 22, B).

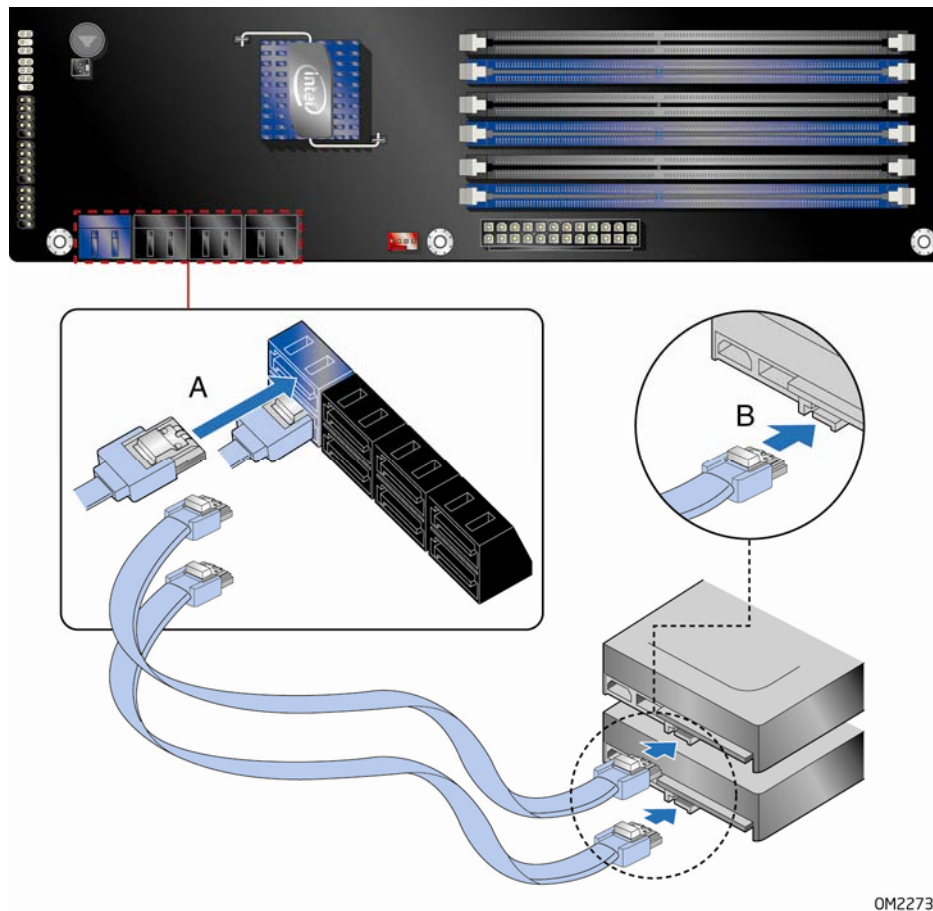
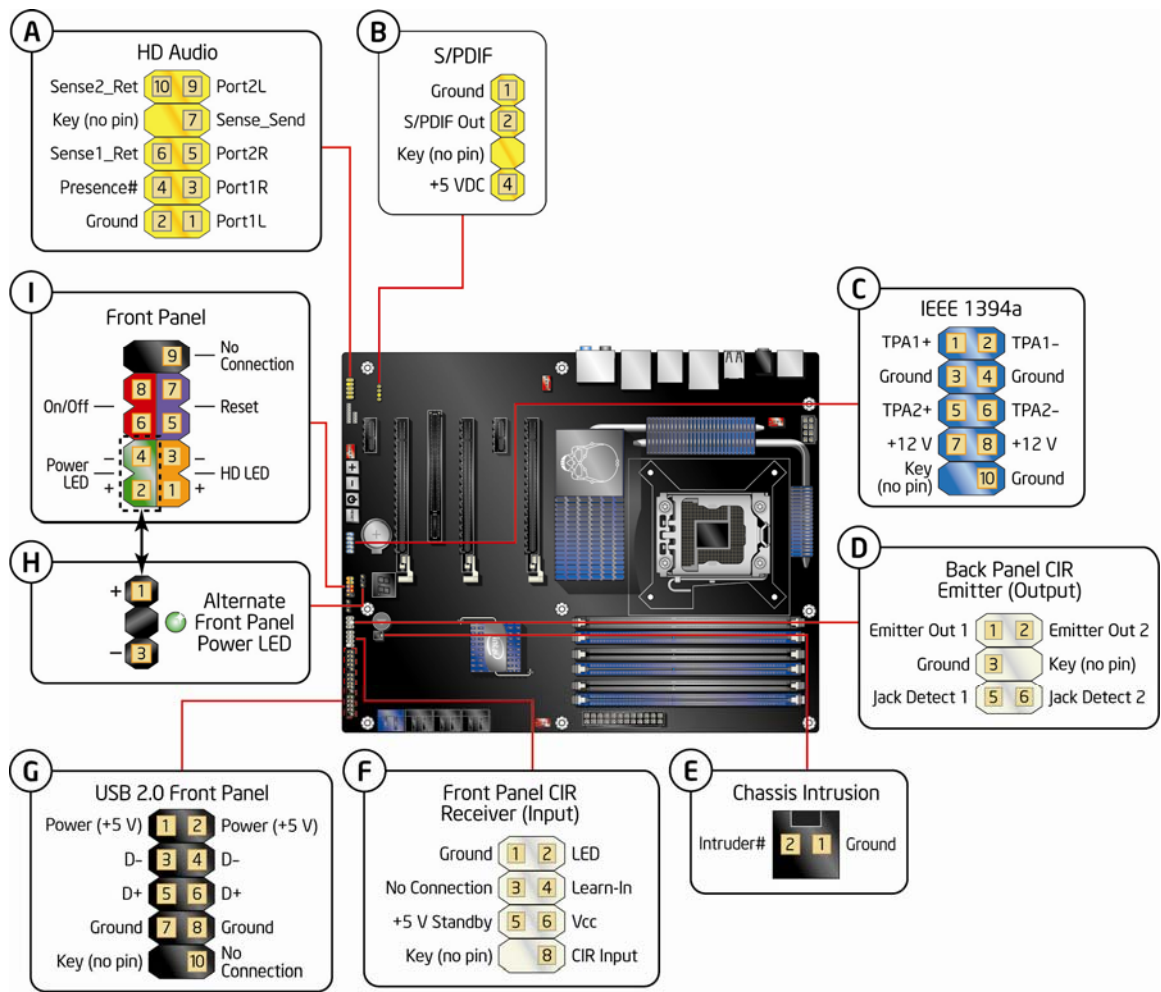

Figure 22. Connecting the Serial ATA Cables

Connecting to the Internal Headers

Before connecting cables to any of the internal headers, observe the precautions in “Before You Begin” on page 31. Figure 23 shows the location of the internal headers on Intel Desktop Board DX58S02.



0M22740

Figure 23. Internal Headers

Front Panel Audio Header

Figure 23, A shows the location of the front panel audio header. Table 5 shows the pin assignments and signal names for the front panel audio header.

Table 5. Front Panel Audio Header Signal Names

Pin	Signal Name	Pin	Signal Name
1	PORT 1L	2	GND
3	PORT 1R	4	PRESENCE#
5	PORT 2R	6	SENSE1_RETURN
7	SENSE_SEND	8	KEY (no pin)
9	PORT 2L	10	SENSE2_RETURN

S/PDIF Header

Figure 23, B shows the location of the S/PDIF header. Table 6 shows the pin assignments and signal names for the S/PDIF connector.

Table 6. S/PDIF Header Signal Names

Pin	Description
1	Vcc
2	S/PDIF Out
3	Ground

IEEE 1394a Header

Figure 23, C shows the location of the IEEE 1394a header. Table 7 shows the pin assignments and signal names for the IEEE 1394a header.

Table 7. IEEE 1394a Header Signal Names

Pin	Signal Name	Pin	Signal Name
1	TPA1+	2	TPA1-
3	Ground	4	Ground
5	TPA2+	6	TPA2-
7	+12 V	8	+12 V
9	Key (no pin)	10	Ground

Consumer IR (CIR) Headers

The Desktop Board has two CIR headers: the input or receiver header (Figure 23, F) and the output or emitter header (Figure 23, D). The receiver header consists of a filtered translated infrared input compliant with Microsoft CIR specifications and a “learning” infrared input. The learning input is a high-pass input which the computer can use to “learn” to speak the infrared communication language of other user remotes. The emitter header consists of two output ports which the computer can use to emulate “learned” infrared commands in order to control external electronic hardware.



NOTE

The Consumer IR option must be enabled in the system BIOS before it can function. Press <F2> at boot to enter the system BIOS, and go to Advanced > Peripheral Configuration > Enhanced Consumer IR, and set this option to Enabled.

Table 8 shows the pin assignments and signal names for the front panel CIR receiver (input) header and Table 9 shows the pin assignments and signal names for the back panel CIR emitter (output) header.

Table 8. Front Panel CIR Receiver (Input) Header Signal Names

Pin	Signal Name	Pin	Signal Name
1	Ground	2	LED
3	No Connection	4	Learn-In
5	+5 V Standby	6	Vcc
7	Key (no pin)	8	CIR Input

Table 9. Back Panel CIR Header Emitter (Output) Header Signal Names

Pin	Signal Name	Pin	Signal Name
1	Emitter Out 1	2	Emitter Out 2
3	Ground	4	Key (no pin)
5	Jack Detect 1	6	Jack Detect 2

Chassis Intrusion Header

Figure 23, E shows the location of the chassis intrusion header. This header can be connected to a mechanical switch on the chassis to detect if the chassis cover is removed.

Table 10 shows the pin assignments and signal names for the chassis intrusion header.

Table 10. Chassis Intrusion Header Signal Names

Pin	Description
1	Intruder
2	Ground

USB 2.0 Headers

Figure 23, G shows the location of the USB 2.0 headers. Table 11 shows the pin assignments and signal names for each USB 2.0 header. Each USB header can be used to connect two USB devices.

Table 11. USB 2.0 Header Signal Names

USB Port A		USB Port B	
Pin	Signal Name	Pin	Signal Name
1	Power (+5 V)	2	Power (+5 V)
3	D-	4	D-
5	D+	6	D+
7	Ground	8	Ground
9	Key	10	No Connection



NOTE

Computer systems that have an unshielded cable attached to a USB port might not meet FCC Class B requirements, even if no device or a low-speed USB device is attached to the cable. Use a shielded cable that meets the requirements for a full-speed USB device.

Alternate Front Panel Power LED Header

Figure 23, H shows the location of the alternate front panel power LED header. Pins 1 and 3 of this header duplicate the signals on pins 2 and 4 of the front panel header. If your chassis has a three-pin power LED cable, connect it to this header.

Table 12 shows the pin assignments and signal names for the alternate front panel power LED header.

Table 12. Alternate Front Panel Power LED Header Signal Names

Pin	Description	In/Out
1	Front panel green LED	Out
2	No pin	
3	Front panel yellow LED	Out

Front Panel Header

Figure 23, I shows the location of the front panel header. Table 13 shows the pin assignments and signal names for the front panel header.

Table 13. Front Panel Header Signal Names

Pin	Description	In/Out	Pin	Description	In/Out
Hard Drive Activity LED			Power LED		
1	Hard disk LED pull-up to +5 V	Out	2	Front panel green LED	Out
3	Hard disk active LED	Out	4	Front panel yellow LED	Out
Reset Switch			On/Off Switch		
5	Ground		6	Power switch	In
7	Reset switch	In	8	Ground	
Power			Not Connected		
9	Power	Out	10	No pin	

Connecting to the Audio System

After installing the RealTek audio driver from the Intel® Express Installer DVD-ROM, the multi-channel audio feature can be enabled. Figure 24 shows the back panel audio connectors. The default connector assignments are shown in the table.

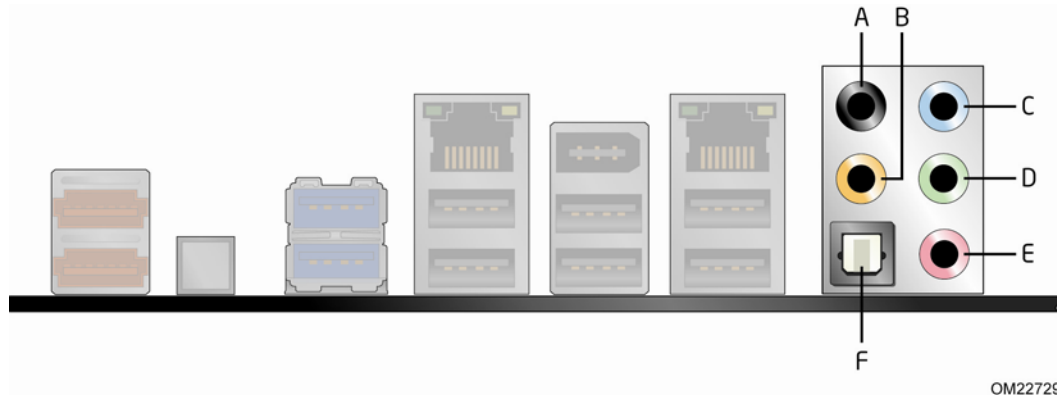

OM22729

Item	Description
A	Surround Left and Right
B	Center Channel and LFE (Subwoofer)
C	Side Surround Left and Right/Line In/Retasking Jack
D	Line Out
E	Mic In
F	S/PDIF Digital Audio Out (Optical)

Figure 24. Back Panel Audio Connectors



NOTE

The back panel line out connector is designed to power either headphones or amplified speakers only. Poor audio quality may occur if passive (non-amplified) speakers are connected to this output.

Connecting Chassis Fan and Power Supply Cables

Connecting Chassis Fan Cables

Connect chassis fan cables to the chassis fan headers on the Desktop Board. Figure 25 shows the location of the chassis fan headers.

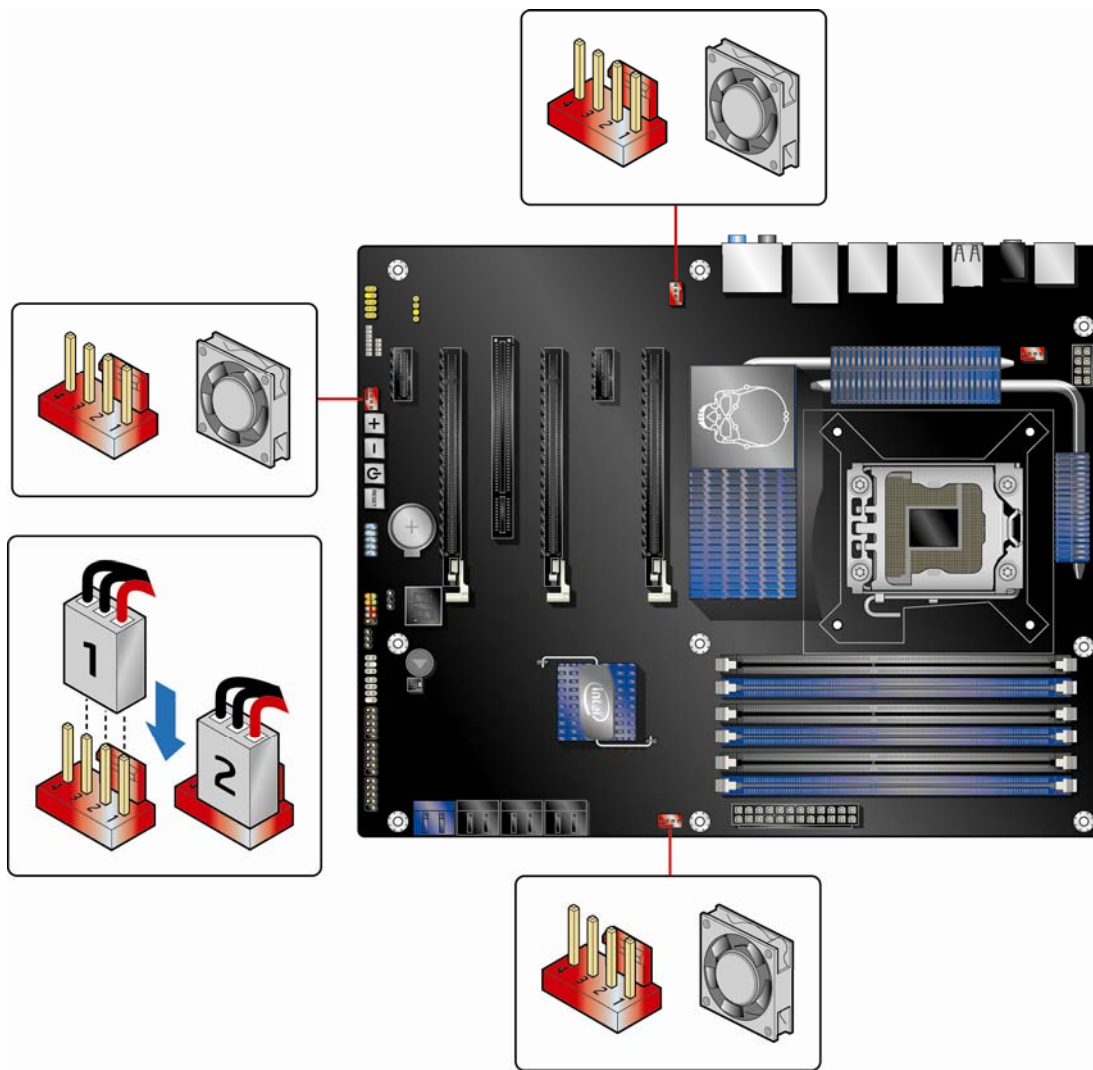

0M22741

Figure 25. Location of the Chassis Fan Headers

Connecting Power Supply Cables

Figure 26 shows the location of the power connectors.



CAUTION

Failure to use an appropriate power supply and/or not connecting the 12 V (Figure 26, A) power connector to the Desktop Board may result in damage to the board or the system may not function properly.

The 2 x 12 pin main power connector (Figure 26, B) is backwards compatible with ATX12V power supplies with 2 x 10 connectors.

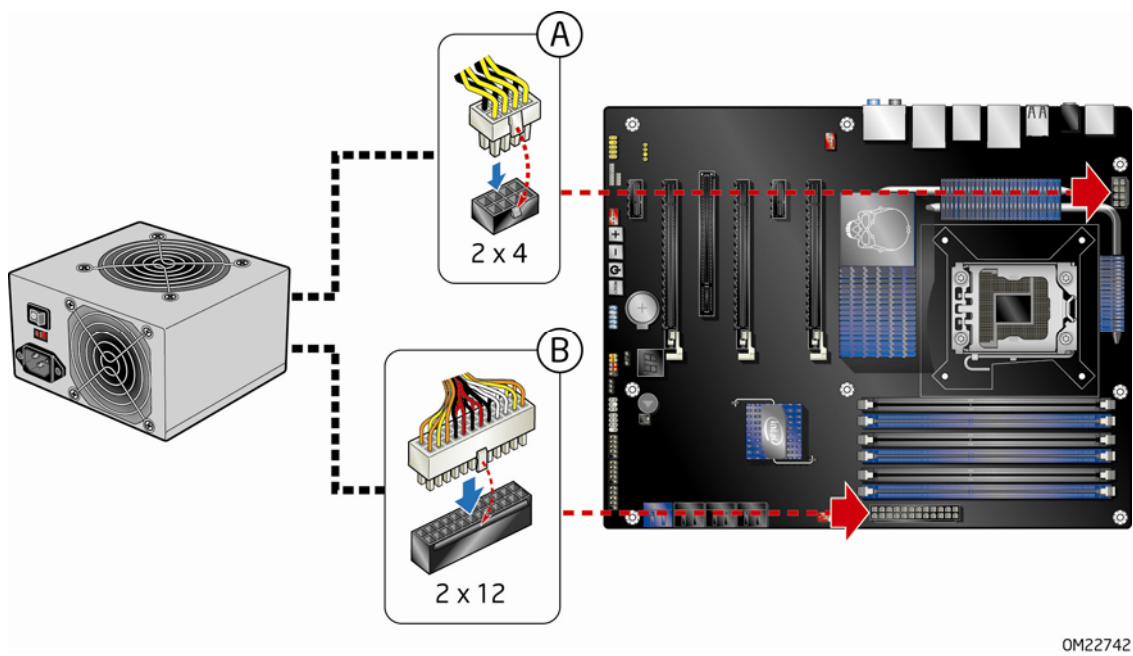

OM22742

Figure 26. Connecting Power Supply Cables

1. Observe the precautions in "Before You Begin" on page 31.
2. Connect the 12 V processor core voltage power supply cable to the 2 x 4 pin connector (Figure 26, A).
3. Connect the main power supply cable to the 2 x 12 pin connector (Figure 26, B).

Setting the BIOS Configuration Jumper



NOTE

Always turn off the power to the computer before moving the jumper. Moving the jumper with the power on may result in unreliable computer operation.

Figure 27 shows the location of the Desktop Board's BIOS configuration jumper block.

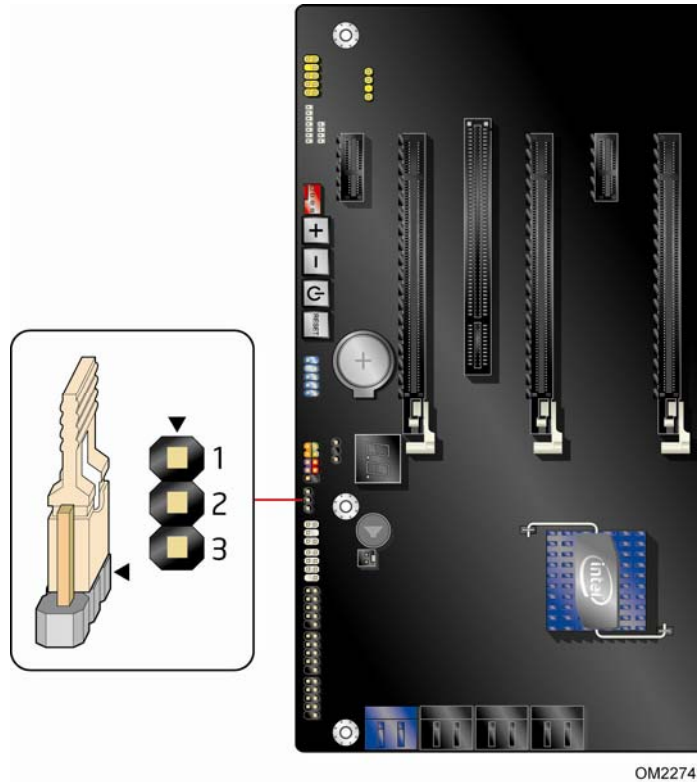
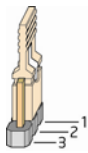
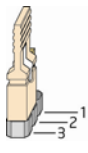
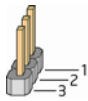

Figure 27. Location of the BIOS Configuration Jumper Block

The three-pin BIOS jumper block enables all board configurations to be done in the BIOS Setup program. Table 14 shows the jumper settings for the BIOS Setup program modes.

Table 14. Jumper Settings for the BIOS Setup Program Modes

Jumper Setting	Mode	Description
	Normal (default) (1-2)	The BIOS uses the current configuration and passwords for booting.
	Configure (2-3)	After the Power-On Self-Test (POST) runs, the BIOS displays the Maintenance Menu. Use this menu to clear passwords.
	Recovery (None)	The BIOS recovers data in the event of a failed BIOS update.

Clearing Passwords

This procedure assumes that the board is installed in the computer and the configuration jumper block is set to normal mode.

1. Observe the precautions in "Before You Begin" on page 31.
2. Turn off all peripheral devices connected to the computer. Turn off the computer. Disconnect the computer's power cord from the AC power source (wall outlet or power adapter).
3. Remove the computer cover.
4. Find the configuration jumper block (see Figure 27).
5. Place the jumper on pins 2-3 as shown below.

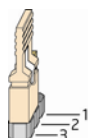

6. Replace the cover, plug in the computer, turn on the computer, and allow it to boot.
7. The computer starts the Setup program. Setup displays the Maintenance menu.
8. Use the arrow keys to select Clear Passwords. Press <Enter> and Setup displays a pop-up screen requesting that you confirm clearing the password. Select Yes and press <Enter>. Setup displays the maintenance menu again.
9. Press <F10> to save the current values and exit Setup.
10. Turn off the computer. Disconnect the computer's power cord from the AC power source.
11. Remove the computer cover.

12. To restore normal operation, place the jumper on pins 1-2 as shown below.

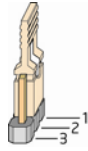

13. Replace the cover, plug in the computer, and turn on the computer.

Replacing the Battery

A coin-cell battery (CR2032) powers the real-time clock and CMOS memory. When the computer is not plugged into a wall socket, the battery has an estimated life of three years. When the computer is plugged in, the standby current from the power supply extends the life of the battery. The clock is accurate to ± 13 minutes/year at 25 °C with 3.3 VSB applied.

When the voltage drops below a certain level, the BIOS Setup program settings stored in CMOS RAM (for example, the date and time) might not be accurate. Replace the battery with an equivalent one. Figure 28 on page 62 shows the location of the battery.



CAUTION

Risk of explosion if the battery is replaced with an incorrect type. Batteries should be recycled where possible. Disposal of used batteries must be in accordance with local environmental regulations.



PRÉCAUTION

Risque d'explosion si la pile usagée est remplacée par une pile de type incorrect. Les piles usagées doivent être recyclées dans la mesure du possible. La mise au rebut des piles usagées doit respecter les réglementations locales en vigueur en matière de protection de l'environnement.



FORHOLDSREGEL

Eksplussionsfare, hvis batteriet erstattes med et batteri af en forkert type. Batterier bør om muligt genbruges. Bortskaffelse af brugte batterier bør foregå i overensstemmelse med gældende miljølovgivning.



OBS!

Det kan oppstå eksplosjonsfare hvis batteriet skiftes ut med feil type. Brukte batterier bør kastes i henhold til gjeldende miljølovgivning.



VIKTIGT!

Risk för explosion om batteriet ersätts med felaktig batterityp. Batterier ska kasseras enligt de lokala miljövårdsbestämmelserna.



VARO

Räjähdysvaara, jos pariston tyyppi on väärä. Paristot on kierrätettävä, jos se on mahdollista. Käytetyt paristot on hävitettävä paikallisten ympäristömääräysten mukaisesti.



VORSICHT

Bei falschem Einsetzen einer neuen Batterie besteht Explosionsgefahr. Die Batterie darf nur durch denselben oder einen entsprechenden, vom Hersteller empfohlenen Batterietyp ersetzt werden. Entsorgen Sie verbrauchte Batterien den Anweisungen des Herstellers entsprechend.



AVVERTIMENTO

Esiste il pericolo di un esplosione se la pila non viene sostituita in modo corretto. Utilizzare solo pile uguali o di tipo equivalente a quelle consigliate dal produttore. Per disfarsi delle pile usate, seguire le istruzioni del produttore.



PRECAUCIÓN

Existe peligro de explosión si la pila no se cambia de forma adecuada. Utilice solamente pilas iguales o del mismo tipo que las recomendadas por el fabricante del equipo. Para deshacerse de las pilas usadas, siga igualmente las instrucciones del fabricante.



WAARSCHUWING

Er bestaat ontploffingsgevaar als de batterij wordt vervangen door een onjuist type batterij. Batterijen moeten zoveel mogelijk worden gerecycled. Houd u bij het weggooien van gebruikte batterijen aan de plaatselijke milieuwetgeving.



ATENÇÃO

Haverá risco de explosão se a bateria for substituída por um tipo de bateria incorreto. As baterias devem ser recicladas nos locais apropriados. A eliminação de baterias usadas deve ser feita de acordo com as regulamentações ambientais da região.



AŠCIAROŽNÁŠĆ

Існуе рызыка выбуху, калі заменены акумулятар неправільнага тыпу. Акумулятары павінны, па магчымасці, перепрацоўвацца. Пазбаўляцца ад старых акумулятараў патрэбна згодна з мясцовым заканадаўствам па экалогіі.



UPOZORNĚNÍ

V případě výměny baterie za nesprávný druh může dojít k výbuchu. Je-li to možné, baterie by měly být recyklovány. Baterie je třeba zlikvidovat v souladu s místními předpisy o životním prostředí.



Προσοχή

Υπάρχει κίνδυνος για έκρηξη σε περίπτωση που η μπαταρία αντικατασταθεί από μία λανθασμένου τύπου. Οι μπαταρίες θα πρέπει να ανακυκλώνονται όταν κάτι τέτοιο είναι δυνατό. Η απόρριψη των χρησιμοποιημένων μπαταριών πρέπει να γίνεται σύμφωνα με τους κατά τόπο περιβαλλοντικούς κανονισμούς.



VIGYÁZAT

Ha a telepet nem a megfelelő típusú telepre cseréli, az felrobbanhat. A telepeket lehetőség szerint újra kell hasznosítani. A használt telepeket a helyi környezetvédelmi előírásoknak megfelelően kell kiselejtezni.



注意

異なる種類の電池を使用すると、爆発の危険があります。リサイクルが可能な地域であれば、電池をリサイクルしてください。使用後の電池を破棄する際には、地域の環境規制に従ってください。



AWAS

Risiko letupan wujud jika bateri digantikan dengan jenis yang tidak betul. Bateri sepatutnya dikitar semula jika boleh. Pelupusan bateri terpakai mestilah mematuhi peraturan alam sekitar tempatan.



OSTRZEŻENIE

Istnieje niebezpieczeństwo wybuchu w przypadku zastosowania niewłaściwego typu baterii. Zużyte baterie należy w miarę możliwości utylizować zgodnie z odpowiednimi przepisami ochrony środowiska.



PRECAUȚIE

Risc de explozie, dacă bateria este înlocuită cu un tip de baterie necorespunzător. Bateriile trebuie reciclate, dacă este posibil. Depozitarea bateriilor uzate trebuie să respecte reglementările locale privind protecția mediului.



ВНИМАНИЕ

При использовании батареи несоответствующего типа существует риск ее взрыва. Батареи должны быть утилизированы по возможности. Утилизация батарей должна проводиться по правилам, соответствующим местным требованиям.



UPOZORNENIE

Ak batériu vymeníte za nesprávny typ, hrozí nebezpečenstvo jej výbuchu. Batérie by sa mali podľa možnosti vždy recyklovať. Likvidácia použitých batérií sa musí vykonávať v súlade s miestnymi predpismi na ochranu životného prostredia.



POZOR

Zamenjava baterije z baterijo drugačnega tipa lahko povzroči eksplozijo. Če je mogoče, baterije reciklirajte. Rabljene baterije zavržite v skladu z lokalnimi okoljevarstvenimi predpisi.



คำเตือน

ระวังการระเบิดที่เกิดจากเปลี่ยนแบตเตอรี่ผิดประเภท หากเป็นไปได้ ควรนำแบตเตอรี่ไปรีไซเคิล การทิ้งแบตเตอรี่ใช้แล้วต้องเป็นไปตามกฎข้อบังคับด้านสิ่งแวดล้อมของท้องถิ่น.



UYARI

Yanlış türde pil takıldığında patlama riski vardır. Piller mümkün olduğunda geri dönüştürülmelidir. Kullanılmış piller, yerel çevre yasalarına uygun olarak atılmalıdır.



ОСТОРОГА

Використовуйте батареї правильного типу, інакше існуватиме ризик вибуху. Якщо можливо, використані батареї слід утилізувати. Утилізація використаних батарей має бути виконана згідно місцевих норм, що регулюють охорону довкілля.



UPOZORNĚNÍ

V případě výměny baterie za nesprávný druh může dojít k výbuchu. Je-li to možné, baterie by měly být recyklovány. Baterie je třeba zlikvidovat v souladu s místními předpisy o životním prostředí.



ETTEVAATUST

Kui patarei asendatakse uue ebasobivat tüüpi patareiga, võib tekkida plahvatusoht. Tühjad patareid tuleb võimaluse korral viia vastavasse kogumispunkti. Tühjade patareide äraviskamisel tuleb järgida kohalikke keskkonnakaitse alaseid reegleid.



FIGYELMEZTETÉS

Ha az elemet nem a megfelelő típusúra cseréli, felrobbanhat. Az elemeket lehetőség szerint újra kell hasznosítani. A használt elemeket a helyi környezetvédelmi előírásoknak megfelelően kell kiselejtezni.



UZMANĪBU

Pastāv eksplozijas risks, ja baterijas tiek nomainītas ar nepareiza veida baterijām. Ja iespējams, baterijas vajadzētu nodot attiecīgos pieņemšanas punktus. Bateriju izmešanai atkritumos jānotiek saskaņā ar vietējiem vides aizsardzības noteikumiem.



DĒMESIO

Naudojant netinkamo tipo baterijas įrenginys gali sprogti. Kai tik įmanoma, baterijas reikia naudoti pakartotinai. Panaudotas baterijas išmesti būtina pagal vietinius aplinkos apsaugos nuostatus.



ATTENZJONI

Riskju ta' splużjoni jekk il-batterija tinbidel b'tip ta' batterija mhux korrett. Il-batteriji għandhom jiġu riċiklati fejn hu possibbli. Ir-rimi ta' batteriji użati għandu jsir skond ir-regolamenti ambjentali lokali.



OSTRZEŻENIE

Ryzyko wybuchu w przypadku wymiany na baterie niewłaściwego typu. W miarę możliwości baterie należy poddać recyklingowi. Zużytych baterii należy pozbywać się zgodnie z lokalnie obowiązującymi przepisami w zakresie ochrony środowiska.

To replace the battery, follow these steps:

1. Observe the precautions in "Before You Begin" (see page 31).
2. Turn off all peripheral devices connected to the computer. Disconnect the computer's power cord from the AC power source (wall outlet or power adapter).
3. Remove the computer cover.
4. Locate the battery on the board (see Figure 28).
5. With a medium flat-bladed screwdriver, gently pry the battery free from its connector. Note the orientation of the "+" and "-" on the battery.
6. Install the new battery in the connector, orienting the "+" and "-" correctly.
7. Replace the computer cover.

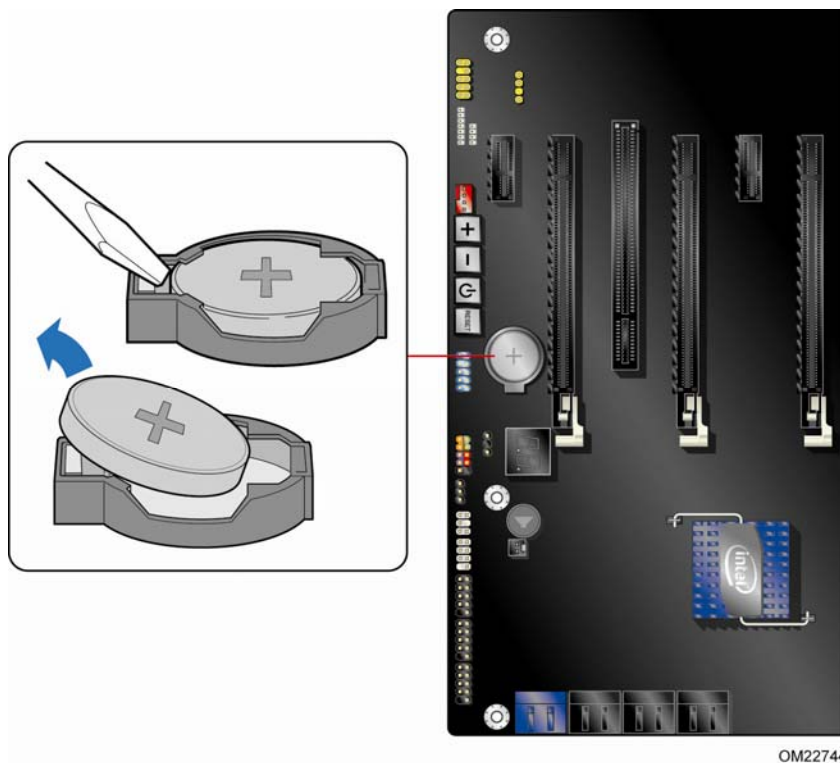

Figure 28. Removing the Battery

Installing the WiFi/Bluetooth* Module in a Desktop Chassis



NOTE

The WiFi/Bluetooth module is supplemental hardware that is included with certain Desktop Boards. Additional WiFi/Bluetooth modules can be ordered online from http://click.intel.com/Desktop_system_parts-0-C97.aspx.*

Installing the WiFi/Bluetooth module that is shipped with Intel Desktop Board DX58SO2 in your desktop system allows you to connect to wireless networks and Bluetooth peripherals.

The recommended installation procedure for a typical desktop chassis is as follows:

1. Observe the precautions in "Before You Begin" on page 31.
2. Make sure that the system is turned off and disconnected from its power source.
3. Remove the plastic cover from an empty 5-1/4 inch drive bay in the chassis bezel (Figure 29, A).
4. Remove the metal filler plate from the internal drive bay (Figure 29, B).
5. Remove the paper backing covering the adhesive on the back of the WiFi/Bluetooth Module and attach the module to the back side of the plastic drive bay cover (Figure 29, C).
6. Connect one end of the USB cable to the connector on the front of the module (Figure 29, D).
7. Reinstall the plastic drive bay cover in the chassis bezel while routing the USB cable into the chassis through the empty drive bay (Figure 29, E).
8. Connect the free end of the USB cable to an unused front panel USB header on the Desktop Board (see Figure 23, G for locations) (Figure 29, F).

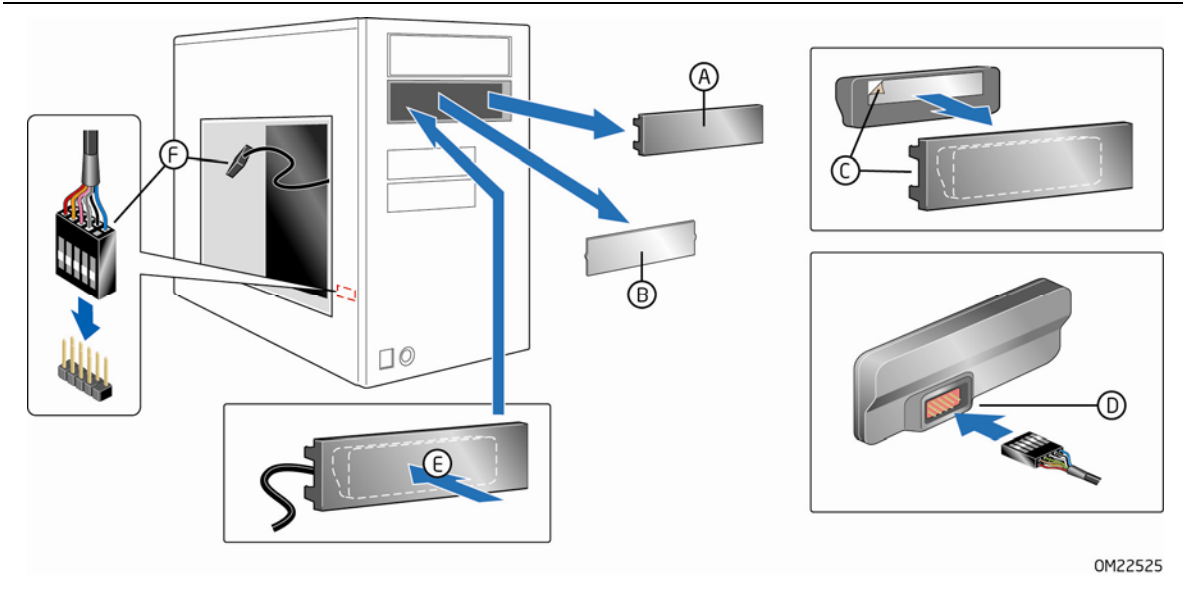

Figure 29. Installing the WiFi/Bluetooth Module

3 Updating the BIOS

The BIOS Setup program can be used to view and change the BIOS settings for the computer. You can access the BIOS Setup program by pressing the <F2> key after the Power-On Self-Test (POST) memory test begins and before the operating system boot begins.

This chapter tells you how to update the BIOS by either using the Intel Express BIOS Update utility or the Iflash Memory Update utility, and how to recover the BIOS if an update fails.

Updating the BIOS with the Intel® Express BIOS Update Utility

With the Intel Express BIOS Update utility you can update the system BIOS while in the Windows environment. The BIOS file is included in an automated update utility that combines the functionality of the Intel Flash Memory Update Utility and the ease of use of Windows-based installation wizards.

To update the BIOS with the Intel Express BIOS Update utility:

1. Go to the Intel World Wide Web site Download Center at <http://downloadcenter.intel.com/>
2. Navigate to the DX58SO2 page. Click on the "BIOS Update" link and then select the Express BIOS Update file.
3. Download the file to your hard drive. (You can also save this file to a removable USB device. This is useful if you are updating the BIOS for multiple identical systems.)
4. Close all other applications. This step is required. Your system will be rebooted at the last Express BIOS Update window.
5. Double-click the executable file from the location on your hard drive where it was saved. This runs the update program.
6. Follow the instructions provided in the dialog boxes to complete the BIOS update.

Updating the BIOS Using the F7 Function Key

To use this BIOS update method:

1. Download and save the Recovery BIOS (.BIO) file to a temporary directory.
2. Copy the .BIO to a USB thumb drive.
3. Plug the thumb drive into a USB port of the target computer.
4. Shut down the target computer.
5. Enable the F7 prompt display:
 - a. Power the computer on.
 - b. Enter the BIOS Setup by pressing F2 during boot.
 - c. Go to the Advanced > Boot Configuration menu.
 - d. Enable Display F7 to Update BIOS
 - e. Press F10 to save and exit.
6. During boot, when the F7 prompt is displayed, press F7 to enter the BIOS Flash Update tool.
7. Select the USB thumb drive and press Enter.
8. Select the .BIO file and press Enter
9. Confirm you want to update the BIOS by pressing Enter.
10. Wait 2-5 minutes for the update to complete.
11. Remove the thumb drive.
12. Restart the computer.

Updating the BIOS with the Intel® Flash Memory Update Utility or the ISO Image BIOS Update File

You can use the information in this section to update the BIOS using either the Intel® Flash Memory Update Utility or the ISO Image BIOS update file.

Obtaining the BIOS Update File

You can update to a new version of the BIOS by using the ISO Image BIOS update file (recommended), or Intel Flash Memory BIOS update file.

The ISO Image BIOS update file is a standardized image of a bootable CD-ROM that can be used to create a bootable CD that will update the BIOS.

The Intel Flash Memory BIOS update file is a compressed file that contains the files you need to update the BIOS. The BIOS update file contains:

- New BIOS file (including the Intel® Management Engine (Intel® ME) Firmware Image))
- Intel® Integrator Toolkit Configuration File (optional)
- Intel Flash Memory Update Utility

You can obtain either of these files through your computer supplier or by navigating to the Intel Desktop Board DX58SO2 page on the Intel World Wide Web site Download Center at <http://downloadcenter.intel.com>.

On the DX58SO2 page, click on the "BIOS Update" link and then select the the Iflash BIOS Update file.

Updating the BIOS with the Intel Flash Memory Update Utility

With the Intel Flash Memory Update Utility you can update the system BIOS from a bootable CD-ROM, bootable USB flash drive, or other bootable USB media. The utility available on the Intel World Wide Web site provides a simple method for creating a bootable CD-ROM that will automatically update your BIOS. The BIOS update files can also be extracted locally to your hard drive and copied to a bootable USB flash drive or other bootable USB media.

The Intel Flash Memory Update Utility allows you to:

- Update the BIOS and Intel Management Engine in flash memory
- Update the language section of the BIOS



NOTE

Review the instructions distributed with the update utility before attempting a BIOS update.



CAUTION

Do not interrupt the process or the system may not function properly.

1. Uncompress the BIOS update file and copy the .BIO file, IFLASH.EXE, and .ITK file (optional) to a bootable USB flash drive or other bootable USB media.
2. Configure the BIOS or use the F10 option during POST to boot to the USB device.
3. Manually run the IFLASH.EXE file from the USB device and manually update the BIOS.

Updating the BIOS with the ISO Image BIOS Update File

The ISO Image BIOS update allows for the update of an Intel® Desktop Board BIOS to the latest production release regardless of the operating system installed on the computer's hard drive and without the need to remove the BIOS configuration jumper. It requires a blank CD-R, a read/writeable CD drive, and software capable of uncompressing and writing the ISO image file to CD.

The image uses ISOLINUX* bootloader and automatically launches a script to upgrade the BIOS via the Intel Flash Memory Utility.



CAUTION

Do not interrupt the process or the system may not function properly.

Follow these instructions to upgrade the BIOS using the ISO Image BIOS file:

1. Download the ISO Image BIOS file.
2. Using software capable of uncompressing and writing an ISO image file to CD, burn the data to a blank CD.



NOTE

Copying the ISO Image BIOS file to CD will not work. The completed CD should contain multiple files and a directory.

3. Insert the CD that was created in the CD-ROM drive of the computer to be upgraded and boot the system.
4. When the "Press ENTER to continue booting from CD-ROM" prompt appears, press the Enter key. The system will boot from the hard drive if no key is pressed within 15 seconds.
5. At the "Welcome to the Intel Desktop Board BIOS Upgrade CD-ROM" page, press any key to confirm the BIOS upgrade operation.
6. Wait for the BIOS upgrade process to complete.



CAUTION

DO NOT POWER DOWN YOUR COMPUTER before the update is complete. The update may take up to 5 minutes.

Recovering the BIOS

It is unlikely that anything will interrupt the BIOS update; however, if an interruption occurs, the BIOS could be damaged. Due to BIOS size and recovery requirements, a CD-R with the .BIO file in the root directory will be required.

You can obtain the Recovery BIOS Update file through your computer supplier or by navigating to the Intel Desktop Board DX58SO2 page on the Intel World Wide Web site Download Center at <http://downloadcenter.intel.com>.

On the DX58SO2 page, click on the "BIOS Update" link and then select the Recovery BIOS Update file.



NOTE

For more information about updating the Intel Desktop Board BIOS or recovering from a BIOS update failure, go to <http://support.intel.com/support/motherboards/desktop/sb/CS-022312.htm>.

4 Configuring for RAID

Configuring for RAID Using Intel® Matrix Storage Technology



NOTE

Intel Matrix Storage Technology requires a Microsoft Windows 7, Microsoft Windows Vista, or Microsoft Windows XP operating system and SATA hard drives.

Configuring the BIOS

1. Assemble your system and attach two or more SATA hard drives to the SATA connectors.
2. Enter system BIOS Setup by pressing <F2> after the Power-On-Self-Test (POST) memory tests begin.
3. Go to **Advanced** → **Drive Configuration** → **Configure SATA as**; ensure that **RAID** is selected.
4. Then save your settings by pressing <F10>.

Creating Your RAID Set

1. Upon re-boot, you will see the following Intel Matrix Storage Manager option ROM status message on the screen: Press <Ctrl-I> to enter the RAID Configuration Utility. Press <Ctrl-I> and enter the RAID Configuration Utility.
2. In the Intel Matrix Storage Manager option ROM Main Menu, select option #1: Create RAID Volume. Enter a volume name (using English alphanumeric ASCII characters) and press <Enter>.
3. Use the arrow keys to select RAID 0 or RAID 1 (if only two SATA drives are available), RAID 5 and RAID 10 (these options will only appear if three or four SATA drives are installed respectively). Press <Enter> once you have selected the RAID LEVEL.
4. Select the drives to be used in the RAID array (only if there are more than two drives available) and press <Enter>.
5. Select the strip size, if necessary, and press <Enter>.
6. Enter the size of the volume (if you enter less than the maximum volume size, you can then create a second RAID array on the remaining portion of your volume) and press <Enter>.
7. Finally, press <Enter> to **Create Volume**.
8. Exit the Option ROM user interface by pressing <Esc> or going to the EXIT option in the MAIN MENU.

Loading the Intel Matrix Storage Technology RAID Drivers and Software

1. Begin Windows Setup by booting from the Windows installation CD.
2. At the beginning of Windows Setup, press <F6> to install a third-party SCSI or RAID driver. When prompted, insert the diskette that contains the Intel Matrix Storage Technology RAID Driver in a USB floppy disk drive. Refer to <http://support.microsoft.com/kb/916196/en-us> for information on supported USB floppy disk drives. Install the Intel® ICH10R SATA RAID Controller driver.
3. Finish the Windows installation and install all necessary drivers.
4. Install the Intel Matrix Storage Console software via the Intel Express Installer CD included with your Desktop Board or after downloading it from the Internet at http://www.intel.com/p/en_US/support?iid=hdr+support. The Intel Matrix Storage Console software can be used to manage the RAID configuration.

Setting Up a "RAID Ready" System

The Intel Matrix Storage Technology Console software offers the flexibility to upgrade from a single Serial ATA drive to RAID without reinstalling the operating system, when a second SATA hard drive is added to the system.

Follow the steps described above in: "Configuring the BIOS" and "Loading the Intel Matrix Storage Technology RAID Drivers and Software."

Once additional SATA drives have been added to the system, open the Intel Matrix Storage Technology Console Software and follow the directions to update to a RAID setup.

Configuring for External RAID Using Marvell* Storage Technology

Configuring the BIOS

1. Assemble your system and attach two External SATA hard drives to the Desktop Board's two back panel eSATA connectors.
2. Enter system BIOS Setup by pressing the <F2> key after the Power-On-Self-Test (POST) memory tests begin.
3. Go to **Advanced** → **Peripheral Configuration** → **Secondary SATA Controller**; ensure that **RAID** is selected.
4. Then save your settings by pressing <F10>.

Creating Your RAID Set

1. Upon re-boot, you will see the following Marvell Storage Manager option ROM status message on the screen: Press <Ctrl-M> to enter the RAID Configuration Utility. Press <Ctrl-M> and enter the RAID Configuration Utility.
2. In the Marvell Storage Manager option ROM Main Menu, select: Create RAID Volume. Enter a volume name (using English alphanumeric ASCII characters) and press <Enter>.
3. Use the arrow keys to select RAID 0 or RAID 1. Press <Enter> once you have selected the RAID LEVEL.
4. Select the strip size, if necessary, and press <Enter>.
5. Enter the size of the volume (if you enter less than the maximum volume size, you can then create a second RAID array on the remaining portion of your volume) and press <Enter>.
6. Finally, press <Enter> to **Create Volume**.
7. Exit the Option ROM user interface by pressing <Esc> or going to the EXIT option in the MAIN MENU.

Loading the Marvell Storage Technology RAID Drivers and Software

1. Begin Windows Setup by booting from the Windows installation CD.
2. At the beginning of Windows Setup, press <F6> to install a third-party SCSI or RAID driver. When prompted, insert the diskette that contains the Marvell Storage Technology RAID Driver in a USB floppy disk drive. Refer to <http://support.microsoft.com/kb/916196/en-us> for information on supported USB floppy disk drives. Install the Marvell 88SE61XX SATA RAID Controller driver.
3. Finish the Windows installation and install all necessary drivers.

A Error Messages and Indicators

Intel Desktop Board DX58SO2 reports POST errors in three ways:

- By sounding a beep code and blinking the front panel power LED
- By displaying an error message on the monitor
- By displaying diagnostic progress codes (POST codes)

BIOS Error Codes

Whenever a recoverable error occurs during POST, the BIOS causes the board's speaker to beep and the front panel power LED to blink an error message indicating the problem (see Table 15).

Table 15. BIOS Beep Codes

Type	Pattern
Processor initialization complete	One 0.5 second beep when the CPU initialization process completes.
POST complete	One 0.5 second beep when POST completes.
Video error	On-off (0.5 seconds each) two times, then 3.0 second pause (off), entire pattern repeats (beeps and pause) until the system is powered off.
Memory error	On-off (0.5 seconds each) three times, then 3.0 second pause (off), entire pattern repeats (beeps and pause) until the system is powered off.
Thermal trip warning	On-off (0.5 seconds each) four times, then 3.0 second pause (off), entire pattern repeats (beeps and pause) until the sixteenth beep, then ends.

Table 16. Front-panel Power LED Blink Codes

Type	Pattern
Processor initialization complete	On when the system powers up, then off for 0.5 seconds.
POST complete	On when the system powers up, then off for 0.5 seconds.
BIOS update in progress	Off when the update begins, then on for 0.5 seconds, then off for 0.5 seconds. The pattern repeats until the BIOS update is complete.
Video error	On-off (0.5 seconds each) two times, then 3.0 second pause (off), entire pattern repeats (blink and pause) until the system is powered off.
Memory error	On-off (0.5 seconds each) three times, then 3.0 second pause (off), entire pattern repeats (blinks and pause) until the system is powered off.
Thermal trip warning	On-off (0.5 seconds each) four times, then 3.0 second pause (off), entire pattern repeats (blinks and pause) until the sixteenth blink, then ends.

BIOS Error Messages

When a recoverable error occurs during the POST, the BIOS displays an error message describing the problem. Table 17 gives an explanation of the BIOS error messages.

Table 17. BIOS Error Messages

Error Message	Explanation
PROCESSOR_THERMAL_TRIP_ERROR	Processor was previously shutdown due to a thermal event (overheating).
CMOS_BATTERY_ERROR	The firmware has detected that a CMOS battery failure occurred.
CMOS_CHECKSUM_ERROR	The firmware has detected that a CMOS Checksum Error occurred.
CMOS_TIMER_ERROR	The firmware has detected that the system date/time has not been set.
MEMORY_SIZE_DECREASE_ERROR	The firmware has detected that the system memory has decreased.
INTRUDER_DETECTION_ERROR	The system chassis was opened.
SPD_TOLER_ERROR	SERIAL PRESENCE DETECT (SPD) device data missing or inconclusive. Properly programmed SPD device data is required for reliable operation.
MEM_OPTIMAL_ERROR	The installed amount of memory in Channel A is not equal to the amount of memory in Channel B. Maximum memory performance is achieved with equal amounts of memory installed in each channel.

Port 80h POST Codes

During the POST, the BIOS generates diagnostic progress codes (POST codes) to I/O port 80h. If the POST fails, execution stops and the last POST code generated is left at port 80h and displayed on the Desktop Board's seven-segment LED display shown in Figure 30. This code is useful for determining the point where an error occurred during the POST.

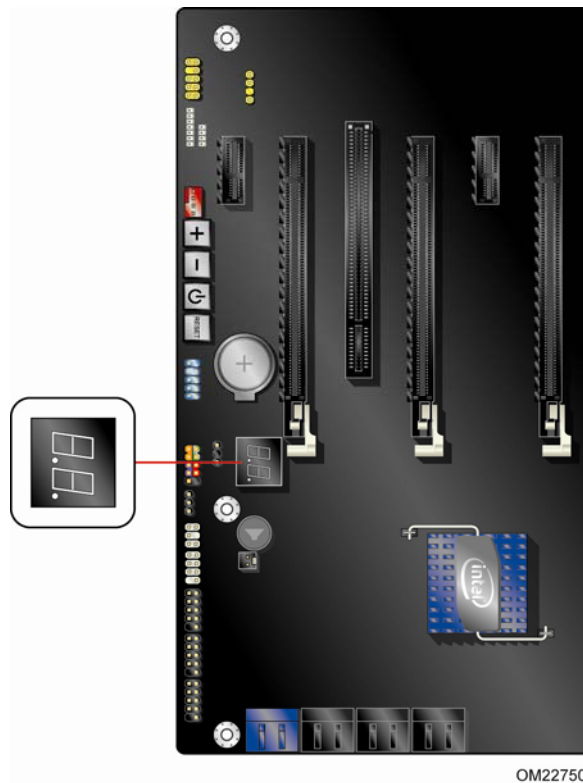

Figure 30. POST Code LED Display

Table 18 lists the Port 80h POST codes in hexadecimal notation.

Table 18. Port 80h POST Codes

POST Code	Description
ACPI S States	
00	Entering S0 state, standard
01-05	Entering S1-S5 state
10, 20, 30, 40, 50	Resuming from S1-S5 state
Security Phase (SEC)	
08	Starting BIOS execution after CPU BIST
09	SPI prefetching and caching
0A, 0B	Load BSP/APS microcode
0C	Platform program base addresses
0D	Wake up all APS
0E	Initialize NEM
0F	Pass entry point of the PEI core
PEI Phase Before MRC	
11	Set bootmode, GPIO init
12	Early chipset register programming
13	Basic PCH init, discrete device init
14	LAN init
15	Exit early platform init driver
16	SMBUS driver init
17, 18	Entry/Exit to SMBUS execute read/write
19, 1A	Entry/Exit to CK505 programming
1B, 1C	Entry/Exit to PEI overclock programming
MEC Memory Detection	
21	MRC entry point
23	Reading SPD from memory DIMMs
24	Detecting presence of memory DIMMs
27	Configuring memory
28	Testing memory
29	Exit MRC driver
PEI After MRC	
2A, 2B	Start/finish programming MTRR settings
PEIMs/Recovery	
31, 33, 34	Recovery has initiate, load, valid

POST Code	Description
CPU Initialization (PEI, DXE, SMM)	
41-43	Begin to end CPU PEI init
44-46	Begin to end CPU SMM init/relocate bases
47-4C	CPU DXE phase begin to end
4D-4F	CPU DXE SMM phase begin to end
I/O Buses	
50-52	PCI enumeration, allocation, hot plug
58, 59	Resetting USB bus
5A, 5B	Resetting SATA bus and all devices
5F	Unrecoverable error, start with PIC
Boot Device Selection (BDS)	
60-6F	BDS driver entry
E4	Entered DXE phase
E7	Waiting for user input
E8	Checking password
E9	Entering BIOS setup
EB	Calling legacy option ROMs
Keyboard/Mouse (PS/2 or USB)	
90-95	Keyboard initialization
98-9B	Mouse initialization
Fixed Media	
B0-BF	Detecting and initializing fixed media
Runtime Phase/EFI Operating System Boot	
F8	EFI boot service ExitBootServices
F9	EFI runtime service SetVirtualAddressMap

B Regulatory Compliance

This appendix contains the following regulatory compliance information for Intel Desktop Board DX58SO2:

- Safety standards
- European Union Declaration of Conformity statement
- Product Ecology statements
- Electromagnetic Compatibility (EMC) regulations
- Product certifications

Safety Standards

Intel Desktop Board DX58SO2 complies with the safety standards stated in Table 19 when correctly installed in a compatible host system.

Table 19. Safety Standards

Regulation	Title
CSA/UL 60950-1	Information Technology Equipment – Safety - Part 1: General Requirements (USA and Canada)
EN 60950-1	Information Technology Equipment – Safety - Part 1: General Requirements (European Union)
IEC 60950-1	Information Technology Equipment – Safety - Part 1: General Requirements (International)

Battery Caution

There is insufficient space on this Desktop Board to provide instructions for replacing and disposing of the Lithium ion coin cell battery. For system safety certification, the statement below or an equivalent statement is required to be permanently and legibly marked on the chassis near the battery.

A suitable caution label is included with Intel Desktop Board DX58SO2.



CAUTION

Risk of explosion if the battery is replaced with an incorrect type. Batteries should be recycled where possible. Disposal of used batteries must be in accordance with local environmental regulations.

For information about replacing the battery, go to page 58.

European Union Declaration of Conformity Statement

We, Intel Corporation, declare under our sole responsibility that the product Intel® Desktop Board DX58S02 is in conformity with all applicable essential requirements necessary for CE marking, following the provisions of the European Council Directives 2004/108/EC (EMC Directive), 2006/95/EC (Low Voltage Directive), and 2002/95/EC (ROHS Directive).

The product is properly CE marked demonstrating this conformity and is for distribution within all member states of the EU with no restrictions.



This product follows the provisions of the European Directives 2004/108/EC, 2006/95/EC and 2002/95/EC.

Čeština Tento výrobek odpovídá požadavkům evropských směrnic 2004/108/EC, 2006/95/EC a 2002/95/EC.

Dansk Dette produkt er i overensstemmelse med det europæiske direktiv 2004/108/EC, 2006/95/EC & 2002/95/EC.

Dutch Dit product is in navolging van de bepalingen van Europees Directief 2004/108/EC, 2006/95/EC & 2002/95/EC.

Eesti Antud toode vastab Euroopa direktiivides 2004/108/EC, ja 2006/95/EC ja 2002/95/EC kehtestatud nõuetele.

Suomi Tämä tuote noudattaa EU-direktiivin 2004/108/EC, 2006/95/EC & 2002/95/EC määräyksiä.

Français Ce produit est conforme aux exigences de la Directive Européenne 2004/108/EC, 2006/95/EC & 2002/95/EC.

Deutsch Dieses Produkt entspricht den Bestimmungen der Europäischen Richtlinie 2004/108/EC, 2006/95/EC & 2002/95/EC.

Ελληνικά Το παρόν προϊόν ακολουθεί τις διατάξεις των Ευρωπαϊκών Οδηγιών 2004/108/EC, 2006/95/EC και 2002/95/EC.

Magyar E termék megfelel a 2004/108/EC, 2006/95/EC és 2002/95/EC Európai Irányelv előírásainak.

Icelandic Þessi vara stenst reglugerð Evrópska Efnahags Bandalagsins númer 2004/108/EC, 2006/95/EC, & 2002/95/EC.

Italiano Questo prodotto è conforme alla Direttiva Europea 2004/108/EC, 2006/95/EC & 2002/95/EC.

Latviešu Šis produkts atbilst Eiropas Direktīvu 2004/108/EC, 2006/95/EC un 2002/95/EC noteikumiem.

Lietuvių Šis produktas atitinka Europos direktyvų 2004/108/EC, 2006/95/EC, ir 2002/95/EC nuostatas.

Malti Dan il-prodott hu konformi mal-provvedimenti tad-Direttivi Ewropej 2004/108/EC, 2006/95/EC u 2002/95/EC.

Norsk Dette produktet er i henhold til bestemmelsene i det europeiske direktivet 2004/108/EC, 2006/95/EC & 2002/95/EC.

Polski Niniejszy produkt jest zgodny z postanowieniami Dyrektyw Unii Europejskiej 2004/108/EC, 2006/95/EC i 2002/95/EC.

Portuguese Este produto cumpre com as normas da Diretiva Europeia 2004/108/EC, 2006/95/EC & 2002/95/EC.

Español Este producto cumple con las normas del Directivo Europeo 2004/108/EC, 2006/95/EC & 2002/95/EC.

Slovensky Tento produkt je v súlade s ustanoveniami európskych direktív 2004/108/EC, 2006/95/EC a 2002/95/EC.

Slovenščina Izdelek je skladen z določbami evropskih direktiv 2004/108/EC, 2006/95/EC in 2002/95/EC.

Svenska Denna produkt har tillverkats i enlighet med EG-direktiv 2004/108/EC, 2006/95/EC & 2002/95/EC.

Türkçe Bu ürün, Avrupa Birliği'nin 2004/108/EC, 2006/95/EC ve 2002/95/EC yönergelerine uyar.

Product Ecology Statements

The following information is provided to address worldwide product ecology concerns and regulations.

Recycling Considerations

As part of its commitment to environmental responsibility, Intel has implemented the Intel® Product Recycling Program to allow retail consumers of Intel's branded products to return used products to selected locations for proper recycling.

Please consult http://intel.com/intel/other/ehs/product_ecology for the details of this program, including the scope of covered products, available locations, shipping instructions, terms and conditions, etc.

中文

作为其对环境责任之承诺的部分，英特尔已实施 Intel Product Recycling Program（英特尔产品回收计划），以允许英特尔品牌产品的零售消费者将使用过的产品退还至指定地点作恰当的重使用处理。

请参考http://intel.com/intel/other/ehs/product_ecology了解此计划的详情，包括涉及产品之范围、回收地点、运送指导、条款和条件等。

Deutsch

Als Teil von Intels Engagement für den Umweltschutz hat das Unternehmen das Intel Produkt-Recyclingprogramm implementiert, das Einzelhandelskunden von Intel Markenprodukten ermöglicht, gebrauchte Produkte an ausgewählte Standorte für ordnungsgemäßes Recycling zurückzugeben.

Details zu diesem Programm, einschließlich der darin eingeschlossenen Produkte, verfügbaren Standorte, Versandanweisungen, Bedingungen usw., finden Sie auf der http://intel.com/intel/other/ehs/product_ecology

Español

Como parte de su compromiso de responsabilidad medioambiental, Intel ha implantado el programa de reciclaje de productos Intel, que permite que los consumidores al detalle de los productos Intel devuelvan los productos usados en los lugares seleccionados para su correspondiente reciclado.

Consulte la http://intel.com/intel/other/ehs/product_ecology para ver los detalles del programa, que incluye los productos que abarca, los lugares disponibles, instrucciones de envío, términos y condiciones, etc.

Français

Dans le cadre de son engagement pour la protection de l'environnement, Intel a mis en œuvre le programme Intel Product Recycling Program (Programme de recyclage des produits Intel) pour permettre aux consommateurs de produits Intel de recycler les produits usés en les retournant à des adresses spécifiées.

Visitez la page Web http://intel.com/intel/other/ehs/product_ecology pour en savoir plus sur ce programme, à savoir les produits concernés, les adresses disponibles, les instructions d'expédition, les conditions générales, etc.

日本語

インテルでは、環境保護活動の一環として、使い終わったインテルブランド製品を指定の場所へ返送していただき、リサイクルを適切に行えるよう、インテル製品リサイクルプログラムを発足させました。

対象製品、返送先、返送方法、ご利用規約など、このプログラムの詳細情報は、http://intel.com/intel/other/ehs/product_ecology (英語)をご覧ください。

Malay

Sebagai sebahagian daripada komitmennya terhadap tanggungjawab persekitaran, Intel telah melaksanakan Program Kitar Semula Produk untuk membenarkan pengguna-pengguna runcit produk jenama Intel memulangkan produk terguna ke lokasi-lokasi terpilih untuk dikitar semula dengan betul.

Sila rujuk http://intel.com/intel/other/ehs/product_ecology untuk mendapatkan butir-butir program ini, termasuklah skop produk yang dirangkumi, lokasi-lokasi tersedia, arahan penghantaran, terma & syarat, dsb.

Portuguese

Como parte deste compromisso com o respeito ao ambiente, a Intel implementou o Programa de Reciclagem de Produtos para que os consumidores finais possam enviar produtos Intel usados para locais selecionados, onde esses produtos são reciclados de maneira adequada.

Consulte o site http://intel.com/intel/other/ehs/product_ecology (em Inglês) para obter os detalhes sobre este programa, inclusive o escopo dos produtos cobertos, os locais disponíveis, as instruções de envio, os termos e condições, etc.

Russian

В качестве части своих обязательств к окружающей среде, в Intel создана программа утилизации продукции Intel (Product Recycling Program) для предоставления конечным пользователям марок продукции Intel возможности возврата используемой продукции в специализированные пункты для должной утилизации.

Пожалуйста, обратитесь на веб-сайт http://intel.com/intel/other/ehs/product_ecology за информацией об этой программе, принимаемых продуктах, местах приема, инструкциях об отправке, положениях и условиях и т.д.

Türkçe

Intel, çevre sorumluluğuna bağlılığının bir parçası olarak, perakende tüketicilerin Intel markalı kullanılmış ürünlerini belirlenmiş merkezlere iade edip uygun şekilde geri dönüştürmesini amaçlayan Intel Ürünleri Geri Dönüşüm Programı'nı uygulamaya koymuştur.

Bu programın ürün kapsamı, ürün iade merkezleri, nakliye talimatları, kayıtlar ve şartlar v.s dahil bütün ayrıntılarını öğrenmek için lütfen http://intel.com/intel/other/ehs/product_ecology web sayfasına gidin.

China RoHS

Intel Desktop Board DX58SO2 is a China RoHS-compliant product.

The China Ministry of Information Industry (MII) stipulates that a material Self Declaration Table (SDT) must be included in a product's user documentation. The SDT for Intel Desktop Board DX58SO2 is shown in Figure 31.

关于符合中国《电子信息产品污染控制管理办法》的声明

**Management Methods on Control of Pollution from
Electronic Information Products
(China RoHS declaration)**

产品中有毒有害物质的名称及含量

部件名称 (Parts)	有毒有害物质或元素					
	铅 (Pb)	汞 (Hg)	镉 (Cd)	六价铬 (Cr6+)	多溴联苯 (PBB)	多溴二苯醚 (PBDE)
主板组件 Motherboard Assembly	×	○	○	○	○	○
<p>○：表示该有毒有害物质在该部件所有均质材料中的含量均在 SJ/T 11363-2006 标准规定的限量要求以下。</p> <p>○：Indicates that this hazardous substance contained in all homogeneous materials of this part is below the limit requirement in SJ/T 11363-2006.</p> <p>×：表示该有毒有害物质至少在该部件的某一均质材料中的含量超出 SJ/T 11363-2006 标准规定的限量要求。</p> <p>×：Indicates that this hazardous substance contained in at least one of the homogeneous materials of this part is above the limit requirement in SJ/T 11363-2006.</p> <p>对销售之日的所售产品,本表显示我公司供应链的电子信息产品可能包含这些物质。注意：在所售产品中可能会也可能不会含有所有所列的部件。</p> <p>This table shows where these substances may be found in the supply chain of our electronic information products, as of the date of sale of the enclosed product. Note that some of the component types listed above may or may not be a part of the enclosed product.</p>						

Figure 31. Intel Desktop Board DX58SO2 China RoHS Material Self Declaration Table

EMC Regulations

Intel Desktop Board DX58SO2 complies with the EMC regulations stated in Table 20 when correctly installed in a compatible host system.

Table 20. EMC Regulations

Regulation	Title
FCC 47 CFR Part 15, Subpart B	Title 47 of the Code of Federal Regulations, Part 15, Subpart B, Radio Frequency Devices. (USA)
ICES-003	Interference-Causing Equipment Standard, Digital Apparatus. (Canada)
EN55022	Limits and methods of measurement of Radio Interference Characteristics of Information Technology Equipment. (European Union)
EN55024	Information Technology Equipment – Immunity Characteristics Limits and methods of measurement. (European Union)
EN55022	Australian Communications Authority, Standard for Electromagnetic Compatibility. (Australia and New Zealand)
CISPR 22	Limits and methods of measurement of Radio Disturbance Characteristics of Information Technology Equipment. (International)
CISPR 24	Information Technology Equipment – Immunity Characteristics – Limits and Methods of Measurement. (International)
VCCI V-3, V-4	Voluntary Control for Interference by Information Technology Equipment. (Japan)
KN-22, KN-24	Korean Communications Commission – Framework Act on Telecommunications and Radio Waves Act. (South Korea)
CNS 13438	Bureau of Standards, Metrology and Inspection. (Taiwan)

FCC Declaration of Conformity

This device complies with Part 15 of the FCC Rules. Operation is subject to the following two conditions: (1) this device may not cause harmful interference, and (2) this device must accept any interference received, including interference that may cause undesired operation.

For questions related to the EMC performance of this product, contact:

Intel Corporation, 5200 N.E. Elam Young Parkway, Hillsboro, OR 97124
1-800-628-8686

This equipment has been tested and found to comply with the limits for a Class B digital device, pursuant to Part 15 of the FCC Rules. These limits are designed to provide reasonable protection against harmful interference in a residential installation. This equipment generates, uses, and can radiate radio frequency energy and, if not installed and used in accordance with the instructions, may cause harmful interference to radio communications. However, there is no guarantee that interference will not occur in a particular installation. If this equipment does cause harmful interference to

radio or television reception, which can be determined by turning the equipment off and on, the user is encouraged to try to correct the interference by one or more of the following measures:

- Reorient or relocate the receiving antenna.
- Increase the separation between the equipment and the receiver.
- Connect the equipment to an outlet on a circuit other than the one to which the receiver is connected.
- Consult the dealer or an experienced radio/TV technician for help.

Any changes or modifications to the equipment not expressly approved by Intel Corporation could void the user's authority to operate the equipment.

Tested to comply with FCC standards for home or office use.

Canadian Department of Communications Compliance Statement

This digital apparatus does not exceed the Class B limits for radio noise emissions from digital apparatus set out in the Radio Interference Regulations of the Canadian Department of Communications.

Le présent appareil numérique n'émet pas de bruits radioélectriques dépassant les limites applicables aux appareils numériques de la classe B prescrites dans le Règlement sur le brouillage radioélectrique édicté par le ministère des Communications du Canada.

Japan VCCI Statement

Japan Statement translation: This is a Class B product based on the standard of the Voluntary Control Council for Interference from Information Technology Equipment (VCCI). If this is used near a radio or television receiver in a domestic environment, it may cause radio interference. Install and use the equipment according to the instruction manual.

この装置は、情報処理装置等電波障害自主規制協議会（VCCI）の基準に基づくクラスB情報技術装置です。この装置は、家庭環境で使用することを目的としていますが、この装置がラジオやテレビジョン受信機に近接して使用されると、受信障害を引き起こすことがあります。
取扱説明書に従って正しい取り扱いをして下さい。

Korea Class B Statement

Korea Class B Statement translation: This equipment is for home use, and has acquired electromagnetic conformity registration, so it can be used not only in residential areas, but also other areas.

이 기기는 가정용(B급)으로 전자파적합등록을 한 기기로서 주로 가정에서 사용하는 것을 목적으로 하며, 모든 지역에서 사용할 수 있습니다.

Ensure Electromagnetic Compatibility (EMC) Compliance

Before computer integration, make sure that the power supply and other modules or peripherals, as applicable, have passed Class B EMC testing and are marked accordingly.

Pay close attention to the following when reading the installation instructions for the host chassis, power supply, and other modules:

- Product certifications or lack of certifications
- External I/O cable shielding and filtering
- Mounting, grounding, and bonding requirements
- Keying connectors when mating the wrong connectors could be hazardous









If the power supply and other modules or peripherals, as applicable, are not Class B EMC compliant before integration, then EMC testing may be required on a representative sample of the newly completed computer.

Product Certifications

Board-Level Certifications

Intel Desktop Board DX58SO2 has the regulatory compliance marks shown in Table 21.

Table 21. Regulatory Compliance Marks

Description	Mark
UL joint US/Canada Recognized Component mark. Includes adjacent UL file number for Intel Desktop Boards: E210882.	
FCC Declaration of Conformity logo mark for Class B equipment.	
CE mark. Declaring compliance to European Union (EU) EMC directive, Low Voltage directive, and RoHS directive.	
Australian Communications Authority (ACA) and New Zealand Radio Spectrum Management (NZ RSM) C-tick mark. Includes adjacent Intel supplier code number, N-232.	
Japan VCCI (Voluntary Control Council for Interference) mark.	
S. Korea KCC (Korean Communications Commission) mark. Includes adjacent KCC certification number: CPU-DX58SO2 (B).	
Taiwan BSMI (Bureau of Standards, Metrology and Inspections) mark. Includes adjacent Intel company number, D33025.	
Printed wiring board manufacturer's recognition mark. Consists of a unique UL recognized manufacturer's logo, along with a flammability rating (solder side).	V-0
China RoHS/Environmentally Friendly Use Period Logo: This is an example of the symbol used on Intel Desktop Boards and associated collateral. The color of the mark may vary depending upon the application. The Environmental Friendly Usage Period (EFUP) for Intel Desktop Boards has been determined to be 10 years.	

Chassis- and Component-Level Certifications

Ensure that the chassis and certain components; such as the power supply, peripheral drives, wiring, and cables; are components certified for the country or market where used. Agency certification marks on the product are proof of certification. Typical product certifications include:

In Europe

The CE mark indicates compliance with all applicable European requirements. If the chassis and other components are not properly CE marked, a supplier's Declaration of Conformity statement to the European EMC directive, Low Voltage directive (as applicable), and ROHS directive, should be obtained. Additionally, other directives, such as the Radio and Telecommunications Terminal Equipment (R&TTE) directive may also apply depending on product features.

In the United States

A certification mark by a Nationally Recognized Testing Laboratory (NRTL) such as UL, CSA, or ETL signifies compliance with safety requirements. Wiring and cables must also be UL listed or recognized and suitable for the intended use. The FCC Class B logo for home or office use signifies compliance with electromagnetic interference (EMI) requirements.

In Canada

A nationally recognized certification mark such as CSA or cUL signifies compliance with safety requirements. The Industry Canada statement on page 86 of this product guide demonstrates compliance with Canadian EMC regulations.

ENERGY STAR*, e-Standby, and ErP Compliance

The US Department of Energy and the US Environmental Protection Agency have continually revised the ENERGY STAR requirements. Intel has worked directly with these two governmental agencies in the definition of the new requirements.

Intel Desktop Board DX58SO2 meets the following program requirements in an adequate system configuration, including appropriate selection of an efficient power supply:

- Energy Star v5.0, category D
- EPEAT
- Korea e-Standby
- European Union Energy-related Products Directive 2009 (ErP)

For information about ENERGY STAR requirements and recommended configurations, go to <http://www.intel.com/go/energystar>.

