

ECM-SKLU

Intel® 6th Generation ULT Processor 3.5" Micro Module

User's Manual

2nd Ed –24 October 2019

FCC Statement



THIS DEVICE COMPLIES WITH PART 15 FCC RULES. OPERATION IS SUBJECT TO THE FOLLOWING TWO CONDITIONS:

- (1) THIS DEVICE MAY NOT CAUSE HARMFUL INTERFERENCE.
- (2) THIS DEVICE MUST ACCEPT ANY INTERFERENCE RECEIVED INCLUDING INTERFERENCE THAT MAY CAUSE UNDESIRE OPERATION.

THIS EQUIPMENT HAS BEEN TESTED AND FOUND TO COMPLY WITH THE LIMITS FOR A CLASS "A" DIGITAL DEVICE, PURSUANT TO PART 15 OF THE FCC RULES.

THESE LIMITS ARE DESIGNED TO PROVIDE REASONABLE PROTECTION AGAINST HARMFUL INTERFERENCE WHEN THE EQUIPMENT IS OPERATED IN A COMMERCIAL ENVIRONMENT. THIS EQUIPMENT GENERATES, USES, AND CAN RADIATE RADIO FREQUENCY ENERGY AND, IF NOT INSTALLED AND USED IN ACCORDANCE WITH THE INSTRUCTION MANUAL, MAY CAUSE HARMFUL INTERFERENCE TO RADIO COMMUNICATIONS.

OPERATION OF THIS EQUIPMENT IN A RESIDENTIAL AREA IS LIKELY TO CAUSE HARMFUL INTERFERENCE IN WHICH CASE THE USER WILL BE REQUIRED TO CORRECT THE INTERFERENCE AT HIS OWN EXPENSE.

Notice

This guide is designed for experienced users to setup the system within the shortest time. For detailed information, please always refer to the electronic user's manual.

Copyright Notice

Copyright © 2019 Avalue Technology Inc., ALL RIGHTS RESERVED.

No part of this document may be reproduced, copied, translated, or transmitted in any form or by any means, electronic or mechanical, for any purpose, without the prior written permission of the original manufacturer.

Trademark Acknowledgement

Brand and product names are trademarks or registered trademarks of their respective owners.

Disclaimer

Avalue Technology Inc. reserves the right to make changes, without notice, to any product, including circuits and/or software described or contained in this manual in order to improve design and/or performance. Avalue Technology assumes no responsibility or liability for the use of the described product(s), conveys no license or title under any patent, copyright, or masks work rights to these products, and makes no representations or warranties that

these products are free from patent, copyright, or mask work right infringement, unless otherwise specified. Applications that are described in this manual are for illustration purposes only. Avalue Technology Inc. makes no representation or warranty that such application will be suitable for the specified use without further testing or modification.

Life Support Policy

Avalue Technology's PRODUCTS ARE NOT FOR USE AS CRITICAL COMPONENTS IN LIFE SUPPORT DEVICES OR SYSTEMS WITHOUT THE PRIOR WRITTEN APPROVAL OF Avalue Technology Inc.

As used herein:

1. Life support devices or systems are devices or systems which, (a) are intended for surgical implant into body, or (b) support or sustain life and whose failure to perform, when properly used in accordance with instructions for use provided in the labeling, can be reasonably expected to result in significant injury to the user.
2. A critical component is any component of a life support device or system whose failure to perform can be reasonably expected to cause the failure of the life support device or system, or to affect its safety or effectiveness.

A Message to the Customer

Avalue Customer Services

Each and every Avalue's product is built to the most exacting specifications to ensure reliable performance in the harsh and demanding conditions typical of industrial environments. Whether your new Avalue device is destined for the laboratory or the factory floor, you can be assured that your product will provide the reliability and ease of operation for which the name Avalue has come to be known.

Your satisfaction is our primary concern. Here is a guide to Avalue's customer services. To ensure you get the full benefit of our services, please follow the instructions below carefully.

Technical Support

We want you to get the maximum performance from your products. So if you run into technical difficulties, we are here to help. For the most frequently asked questions, you can easily find answers in your product documentation. These answers are normally a lot more detailed than the ones we can give over the phone. So please consult the user's manual first.

To receive the latest version of the user's manual; please visit our Web site at:

<http://www.avalue.com.tw/>

ECM-SKLU User's Manual

Product Warranty

Avalue warrants to you, the original purchaser, that each of its products will be free from defects in materials and workmanship for two years from the date of purchase.

This warranty does not apply to any products which have been repaired or altered by persons other than repair personnel authorized by Avalue, or which have been subject to misuse, abuse, accident or improper installation. Avalue assumes no liability under the terms of this warranty as a consequence of such events. Because of Avalue's high quality-control standards and rigorous testing, most of our customers never need to use our repair service. If any of Avalue's products is defective, it will be repaired or replaced at no charge during the warranty period. For out-of-warranty repairs, you will be billed according to the cost of replacement materials, service time, and freight. Please consult your dealer for more details. If you think you have a defective product, follow these steps:

1. Collect all the information about the problem encountered. (For example, CPU type and speed, Avalue's products model name, hardware & BIOS revision number, other hardware and software used, etc.) Note anything abnormal and list any on-screen messages you get when the problem occurs.
2. Call your dealer and describe the problem. Please have your manual, product, and any helpful information available.
3. If your product is diagnosed as defective, obtain an RMA (return material authorization) number from your dealer. This allows us to process your good return more quickly.
4. Carefully pack the defective product, a complete Repair and Replacement Order Card and a photocopy proof of purchase date (such as your sales receipt) in a shippable container. A product returned without proof of the purchase date is not eligible for warranty service.
5. Write the RMA number visibly on the outside of the package and ship it prepaid to your dealer.

Content

1. Getting Started	8
1.1 Safety Precautions.....	8
1.2 Packing List.....	8
1.3 Document Amendment History	9
1.4 Manual Objectives.....	10
1.5 System Specifications	11
1.6 Architecture Overview—Block Diagram	13
2. Hardware Configuration	14
2.1 Product Overview.....	15
2.2 Jumper and Connector List.....	17
2.3 Setting Jumpers & Connectors	19
2.3.1 Serial port 1 pin9 signal select (JRI1)	19
2.3.2 Clear CMOS (JBAT1).....	19
2.3.3 LCD backlight brightness adjustment (JBKL_SEL1).....	20
2.3.4 AT/ATX Input power select (JAT1).....	20
2.3.5 LCD inverter connector (JBKL1)	21
2.3.6 CPU fan connector (CPU_FAN1).....	21
2.3.7 System fan connector (SYS_FAN1).....	22
2.3.8 Serial port 2/3/4/5/6 connector (JCOM2/3/4/5/6)	22
2.3.9 Serial port 2 in RS-422/485 mode (J422_485).....	23
2.3.10 General purpose I/O connector (JDIO1).....	23
2.3.11 SATA Power connector (SATA_PWR1)	24
2.3.12 Power connector (PWR1)	24
2.3.13 LVDS connector (JLVDS1)	25
2.3.14 USB2.0 connector (JUSB56)	26
2.3.15 SPI connector (JSPI1)	26
2.3.16 EC Debug connector (JEC_ROM1).....	27
2.3.17 Battery connector (BAT1)	27
2.3.18 LPC connector (JLPC1)	28
2.3.19 Front Panel connector (JFP1).....	28
2.3.20 PC Buzzer connector (JBZ1)	29
2.3.21 AUDIO connector (JAUDIO1).....	29
2.3.21.1 Signal Description – Audio connector (JAUDIO1).....	29
2.4 AUX-032 User's Guide.....	30
2.4.1 Jumper and Connector Layout.....	30
2.4.2 Jumper and Connector List.....	30

ECM-SKLU User's Manual

2.4.3	Setting Jumper and Connector	31
2.5	Cooler installation.....	32
3	BIOS Setup	33
3.1	Introduction	34
3.2	Starting Setup	34
3.3	Using Setup	35
3.4	Getting Help.....	36
3.5	In Case of Problems.....	36
3.6	BIOS setup.....	37
3.6.1	Main Menu.....	37
3.6.1.1	System Language.....	38
3.6.1.2	System Date	38
3.6.1.3	System Time.....	38
3.6.2	Advanced Menu	38
3.6.2.1	Trusted Computing	39
3.6.2.2	APCI Settings	39
3.6.2.3	AMT Configuration.....	40
3.6.2.4	PCH-FW Configuration	41
3.6.2.4.1	Firmware Update Configuration.....	42
3.6.2.5	IT8528 Super IO Configuration.....	42
3.6.2.5.1	Serial Port 1 Configuration	43
3.6.2.5.2	Serial Port 2 Configuration	44
3.6.2.5.3	Serial Port 3 Configuration	44
3.6.2.5.4	Serial Port 4 Configuration	45
3.6.2.5.5	Serial Port 5 Configuration	45
3.6.2.5.6	Serial Port 6 Configuration	46
3.6.2.6	H/W Monitor.....	46
3.6.2.7	S5 RTC Wake Settings.....	47
3.6.2.8	Serial Port Console Redirection	47
3.6.2.8.1	Legacy Console Redirection Settings	48
3.6.2.9	CPU Configuration.....	48
3.6.2.10	Intel TXT Configuration.....	50
3.6.2.11	SATA Configuration	50
3.6.2.12	Network Stack Configuration	51
3.6.2.13	CSM Configuration	52
3.6.2.14	NVMe Configuration	52
3.6.2.15	USB Configuration	53
3.6.3	Chipset.....	54
3.6.3.1	System Agent (SA) Configuration.....	54
3.6.3.1.1	Graphics Configuration	55

3.6.3.1.2	Memory Configuration	56
3.6.3.2	PCH-IO Configuration.....	57
3.6.3.2.1	PCI Express Configuration	57
3.6.3.2.2	USB Configuration	62
3.6.3.2.3	HD Audio Configuration	62
3.6.4	Security.....	63
3.6.4.1	Secure Boot menu	64
3.6.4.1.1	Key Management.....	64
3.6.5	Boot	68
3.6.6	Save and exit.....	69
3.6.6.1	Save Changes and Reset.....	69
3.6.6.2	Discard Changes and Reset.....	70
3.6.6.3	Restore Defaults	70
3.6.6.4	Launch EFI Shell from filesystem device	70
4.	Drivers Installation.....	71
4.1	Install Chipset Driver	72
4.2	Install ME Driver	73
4.3	Install VGA Driver.....	74
4.4	Install Audio Driver (For Realtek ALC892)	76
4.5	Install Ethernet Driver.....	77
4.6	Install Serial IO Driver	79
4.7	Install IRST Driver	81
5.	Mechanical Drawing	83

1. Getting Started

1.1 Safety Precautions

Warning!



Always completely disconnect the power cord from your chassis whenever you work with the hardware. Do not make connections while the power is on. Sensitive electronic components can be damaged by sudden power surges. Only experienced electronics personnel should open the PC chassis.

Caution!



Always ground yourself to remove any static charge before touching the CPU card. Modern electronic devices are very sensitive to static electric charges. As a safety precaution, use a grounding wrist strap at all times. Place all electronic components in a static-dissipative surface or static-shielded bag when they are not in the chassis.

1.2 Packing List

Before you begin installing your single board, please make sure that the following materials have been shipped:

- 1 x 3.5" ECM-SKLU Micro Module
- 1 x AUX-032 daughter board
- 1 x Cable set contains the followings:
 - 1 x Audio cable (12pin,2.0 pitch)
 - 1 x USB 2.0 cable (10P/2.0mm-10P/2.0mm)
 - 1 x Serial ATA cable (7-pin, standard)
 - 1 x Wire SATA power cable (15-pin,2P/2.0mm)
 - 1 x Flat cable 9P(M)-PHD 10P/2.0mm)
- 3M foam (VHB-4622 10mm*20mm*1.1mm)



If any of the above items is damaged or missing, contact your retailer.

1.3 Document Amendment History

Revision	Date	By	Comment
1 st	April 2017	Avalue	Initial Release
2 nd	October 2019	Avalue	Update System Specifications

1.4 Manual Objectives

This manual describes in details Avalue Technology ECM-SKLU Single Board.

We have tried to include as much information as possible but we have not duplicated information that is provided in the standard IBM Technical References, unless it proved to be necessary to aid in the understanding of this board.

We strongly recommend that you study this manual carefully before attempting to set up ECM-SKLU or change the standard configurations. Whilst all the necessary information is available in this manual we would recommend that unless you are confident, you contact your supplier for guidance.

Please be aware that it is possible to create configurations within the CMOS RAM that make booting impossible. If this should happen, clear the CMOS settings, (see the description of the Jumper Settings for details).

If you have any suggestions or find any errors regarding this manual and want to inform us of these, please contact our Customer Service department with the relevant details.

1.5 System Specifications

System	
CPU	Onboard 6th generation Intel® Skylake i7/i5/i3 2+2e SoC ULT Processor (15W)
BIOS	AMI uEFI BIOS, 128 Mbit SPI Flash ROM iAMT supported
I/O Chip	EC(IT8528E)
System Memory	1 x 260-Pin DDR4 2133MTs SO-DIMM (support non-ECC only)
SSD	1 x M.2(2242) (B key support SATA or PCIE, USB3 & USB2) (M.2 can support PCIEX2 or SSIC by OEM BIOS) 1 x mSATA, supported from MiniPCle
Watchdog Timer	H/W Reset, 1sec. – 65535sec.
H/W Status Monitor	Monitoring CPU Temperature, Voltage and FAN Status with Auto Throttling Control
Expansion	1 x Full-Size Mini PCI Express Mini Card with mSATA supported (half size support with standoff) 1 x M.2 (2242) B-Key with Micro SIM Card connector for 3G/4G
I/O	
MIO	1 x SATA III 1 x DB-9 male connector for COM1(RS-232) 1 x JCOM2 (RS232/422/485 selected by GPIO w/ Auto Flow), 422/485 with 2x3 pin header 4 x RS-232 (Pin Header) LPC, SPI
USB	4 x USB3.0(dual deck USB connector for 2 USB3.0 port), 2 x USB 2.0(Wafer)
GPIO	8-bit GPIO
Display	
Chipset	Intel® Skylake Processor integrated Graphics
Resolution	LVDS: 1920 x 1200@60Hz 2 x HDMI: 4096 x 2160@24Hz
Multiple Display	Triple display
HDMI	HDMI 1.4b
LCD Interface	Dual channel 18/24-bit LVDS (via 7511B)
Audio	
AC97 Codec	Realtek ALC892 HD codec Supports 5.1-CH Audio (Co-lay with ALC888S-VD2-GR)
Audio Amp	Line in ,Line-Out, Mic in
Ethernet	
LAN Chip	1 x Intel I211AT GbE controller (Co-lay I210AT)

ECM-SKLU User's Manual

	1 x Intel I219LM Gigabit Ethernet PHY
Ethernet Interface	10/100/1000 Base-Tx compatible
Internal I/O Connectors	
Fan	2 x Fan 4P-Wafer
Buzzer	Buzzer with wafer header
CMOS Battery	Wire CR2032
Power On	2 x 5-pin header
Audio	2 x 6-pin header
COM	5 x RS232 2 X 3-pin header for RS422/485 (COM2)
USB	2 x 5-pin header support 2 USB2.0 port
Rear I/O Connectors	
USB	4 x USB3.0
LAN	2 x Ethernet
HDMI	2 x HDMI
COM	1 X D-sub 9 pin (RS232)
LED	Stack LED for PWR and HDD LED
Mechanical & Environmental	
Power Requirement	+12V ~ +26V
ACPI	Single power ATX Support S0, S3, S4, S5 ACPI 5.0 Compliant
Power Type	AT / ATX
Operating Temp.	0°C ~ 60°C
Storage Temp.	-40°C ~ 75°C
Operating Humidity	0% ~ 90% relative humidity, non-condensing
Size (L x W)	5.7" x 4" (146mm x 101mm)
Weight	0.44 lbs (0.2 Kg)
OS Support	Win10/8.1/7/Linux (listed in accordance with Intel document)



Note: Specifications are subject to change without notice.

1.6 Architecture Overview—Block Diagram

The following block diagram shows the architecture and main components of ECM-SKLU.

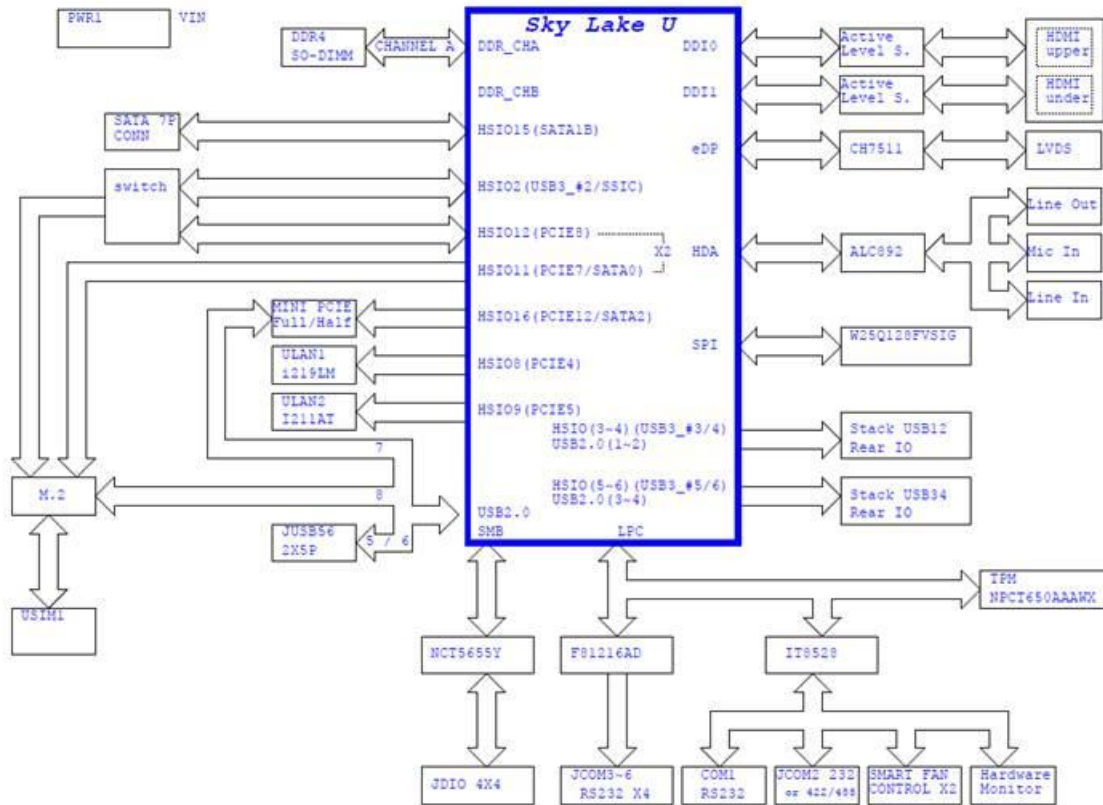

2. Hardware Configuration

2.1 Product Overview

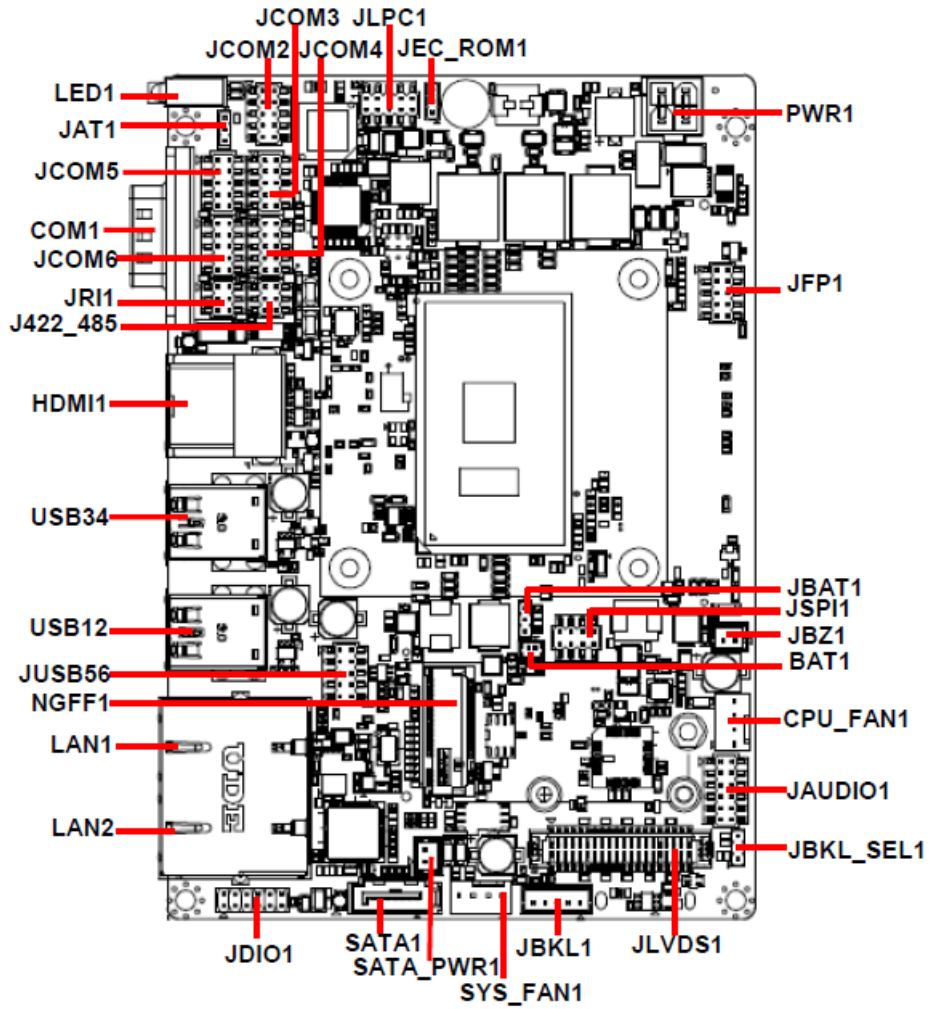

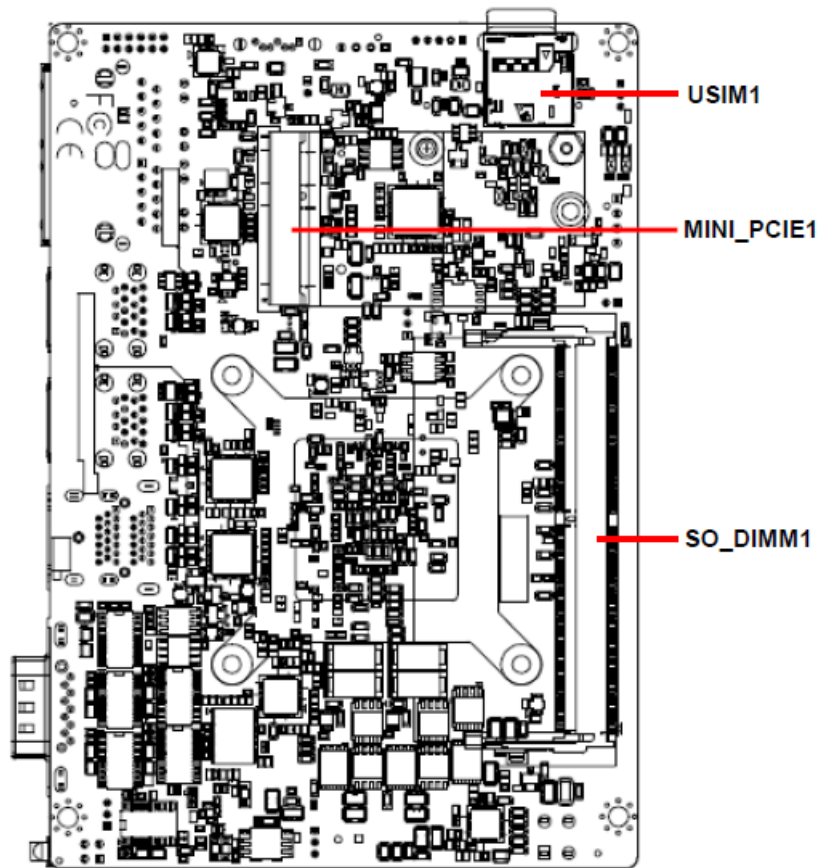

2.2 Jumper and Connector List

You can configure your board to match the needs of your application by setting jumpers. A jumper is the simplest kind of electric switch.

It consists of two metal pins and a small metal clip (often protected by a plastic cover) that slides over the pins to connect them. To “close” a jumper you connect the pins with the clip. To “open” a jumper you remove the clip. Sometimes a jumper will have three pins, labeled 1, 2, and 3. In this case, you would connect either two pins.

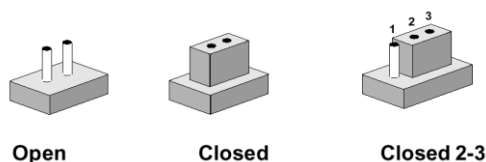

The jumper settings are schematically depicted in this manual as follows:



A pair of needle-nose pliers may be helpful when working with jumpers.

Connectors on the board are linked to external devices such as hard disk drives, a keyboard, or floppy drives. In addition, the board has a number of jumpers that allow you to configure your system to suit your application.

If you have any doubts about the best hardware configuration for your application, contact your local distributor or sales representative before you make any changes.

The following tables list the function of each of the board's jumpers and connectors.

Jumpers

Label	Function	Note
JRI1	Serial port 1 pin9 signal select	3 x 2 header, pitch 2.00mm
JAT1	AT/ATX Input power select	3 x 1 header, pitch 2.00mm
JBKL_SEL1	LCD backlight brightness adjustment	3 x 1 header, pitch 2.00mm
JBAT1	Clear CMOS	3 x 1 header, pitch 2.00mm

Connectors

Label	Function	Note
JBKL1	LCD inverter connector	5 x 1 wafer, pitch 2.00mm Matching Connector: JST PHR-5
CPU_FAN1	CPU fan connector	4 x 1 wafer, pitch 2.54mm
SYS_FAN1	System fan connector	4 x 1 wafer, pitch 2.54mm
COM1	Serial Port 1 connector	D-sub 9 pin, male

ECM-SKLU User's Manual

JCOM2/3/4/5/6	Serial Port 2/3/4/5/6 connector	5 x 2 header, pitch 2.00mm
J422_485	Serial port 2 in RS-422/485 mode	3 x 2 header, pitch 2.00mm
JDIO1	General purpose I/O connector	6 x 2 wafer, pitch 2.00mm
NGFF1	M.2 KEY-B 2242 connector	
LED1	HDD/Power LED indicator	
JLVDS1	LVDS connector	DIN 40-pin wafer, pitch 1.25mm Matching Connector: Hirose DF13-40DS-1.25C
JFP1	Front Panel connector	5 x 2 header, pitch 2.00mm
USB12/34	4 x USB3.0 connector	
JUSB56	USB2.0 connector	5 x 2 header, pitch 2.00mm
JBZ1	Buzzer connector	2 x 1 wafer, pitch 2.00mm
JAUDIO1	Audio connector	6 x 2 header, pitch 2.00mm
LAN1/2	RJ-45 Ethernet 1/2	
BAT1	Battery connector	2 x 1 wafer, pitch 1.25mm
JLPC1	LPC connector	5 x 2 header, pitch 2.00mm
PWR1	Power connector	2 x 2 wafer, pitch 4.20mm
JSPI1	SPI connector	4 x 2 header, pitch 2.00mm
JEC_ROM1	EC Debug connector	3 x 1 header, pitch 2.00mm
SATA_PWR1	SATA Power connector	2 x 1 wafer, pitch 2.00mm
SATA1	Serial ATA connector	
HDMI1	HDMI connector	
SO_DIMM1	DDR4 SODIMM socket	
MINI_PCIE1	Mini-PCle_connector	
USIM1	SIM card slot	

2.3 Setting Jumpers & Connectors

2.3.1 Serial port 1 pin9 signal select (JRI1)

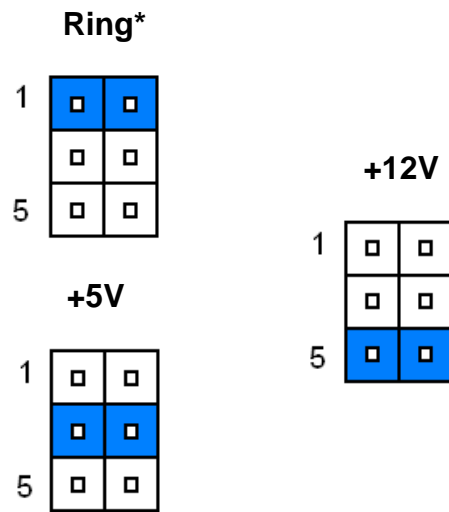
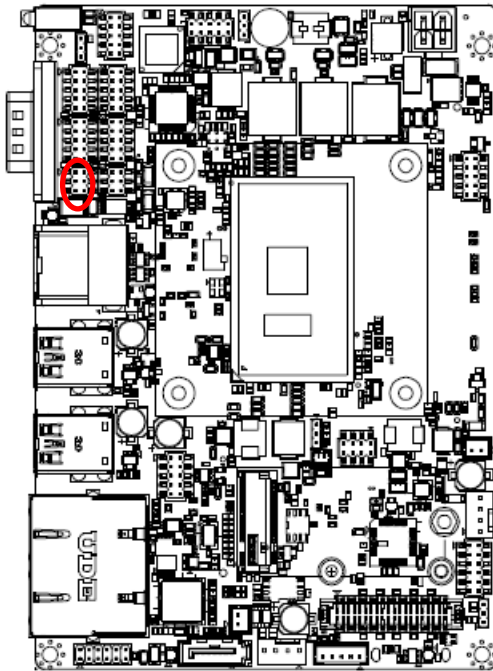

* Default

2.3.2 Clear CMOS (JBAT1)

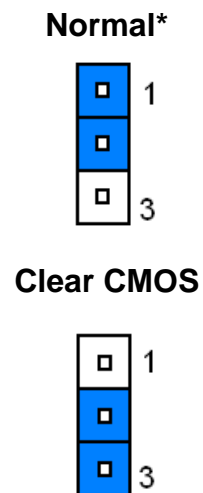
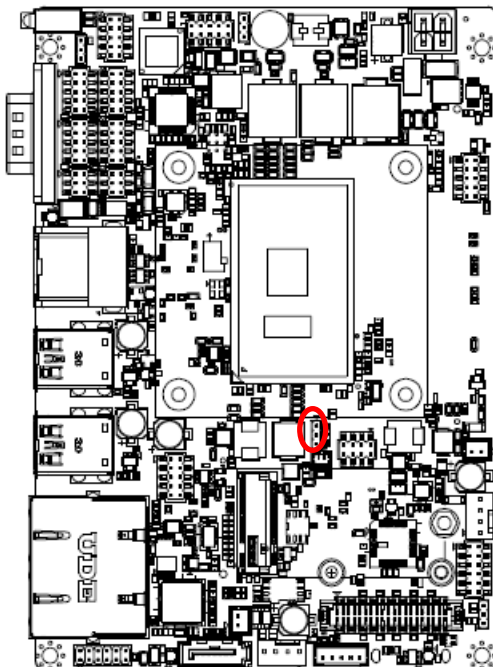

* Default

2.3.3 LCD backlight brightness adjustment (JBKL_SEL1)

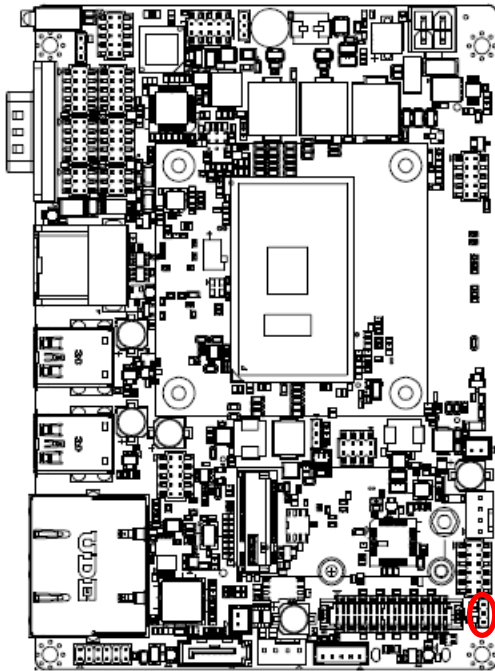

PWM Mode*

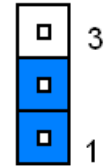

DC Mode

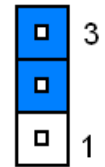

* Default

2.3.4 AT/ATX Input power select (JAT1)

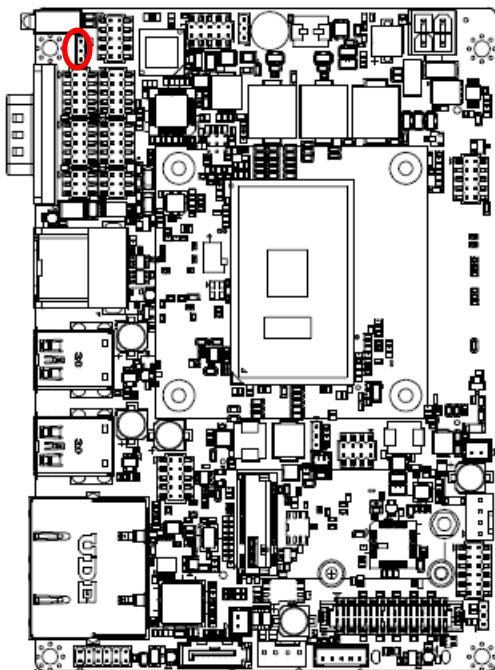

AT*

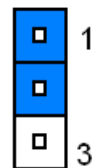

ATX

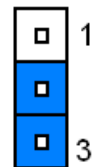

* Default

2.3.5 LCD inverter connector (JBKL1)

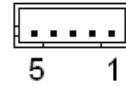
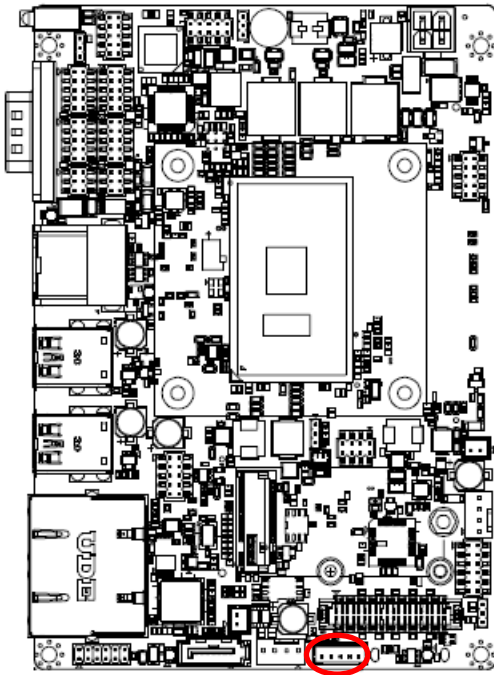

Signal	PIN
+12V	1
GND	2
BKLEN	3
VBRIGHT	4
+5V	5

2.3.6 CPU fan connector (CPU_FAN1)

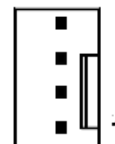
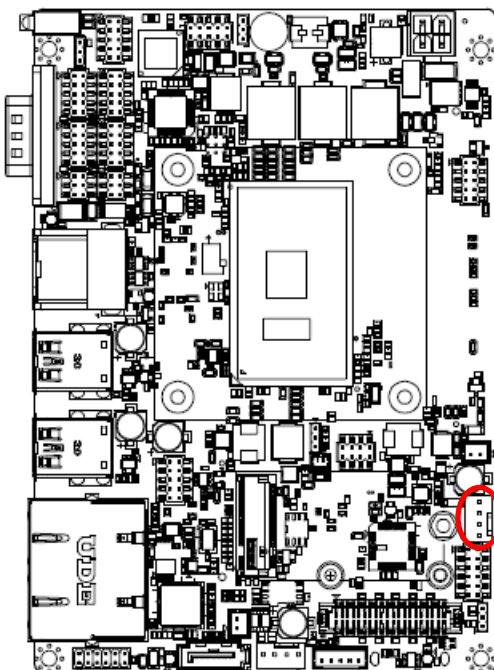

Signal	PIN
PWM_FAN0	4
EC_TACH0	3
+12V	2
GND	1

2.3.7 System fan connector (SYS_FAN1)

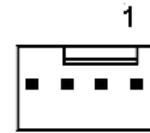
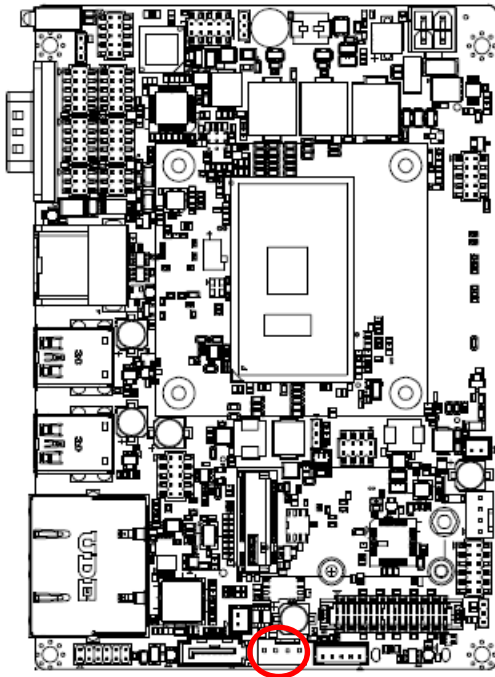

Signal	PIN
GND	1
+12V	2
EC_TACH1	3
PWM_FAN1	4

2.3.8 Serial port 2/3/4/5/6 connector (JCOM2/3/4/5/6)

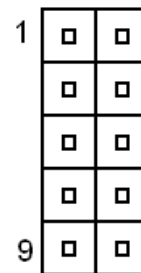
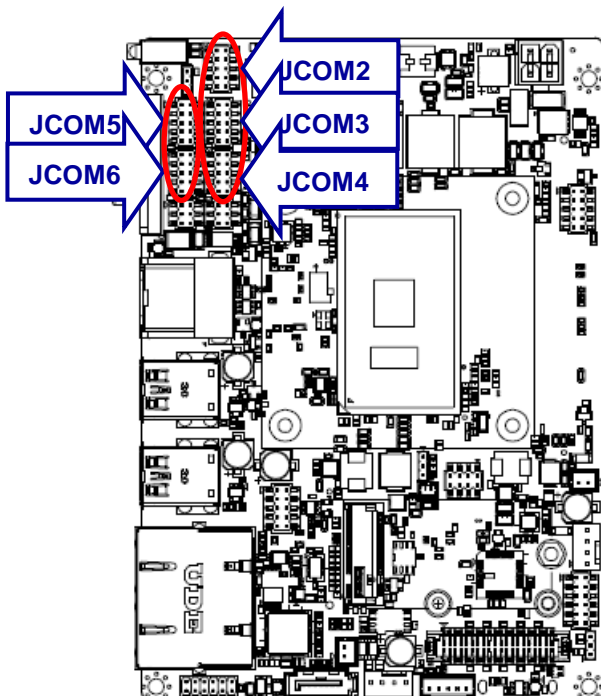

Signal	PIN	PIN	Signal
COM_DCD#	1	2	COM_RXD
COM_TXD	3	4	COM_DTR#
GND	5	6	COM_DSR#
COM_RTS#	7	8	COM_CTS#
COM_RI#	9	10	NC

2.3.9 Serial port 2 in RS-422/485 mode (J422_485)

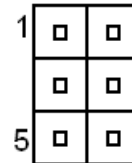
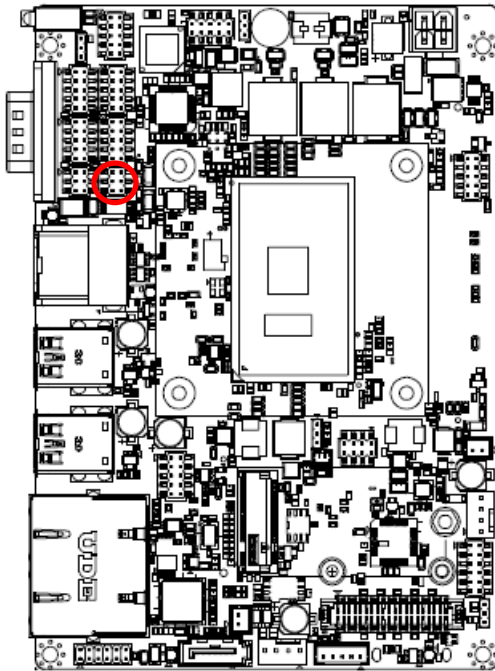

Signal	PIN	PIN	Signal
485-422_TXDN	1	2	485-422_TXDP
422_RXDP	3	4	422_RXDN
+5V	5	6	GND

2.3.10 General purpose I/O connector (JDIO1)

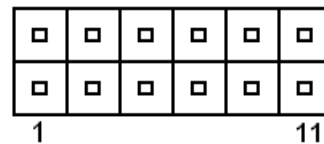
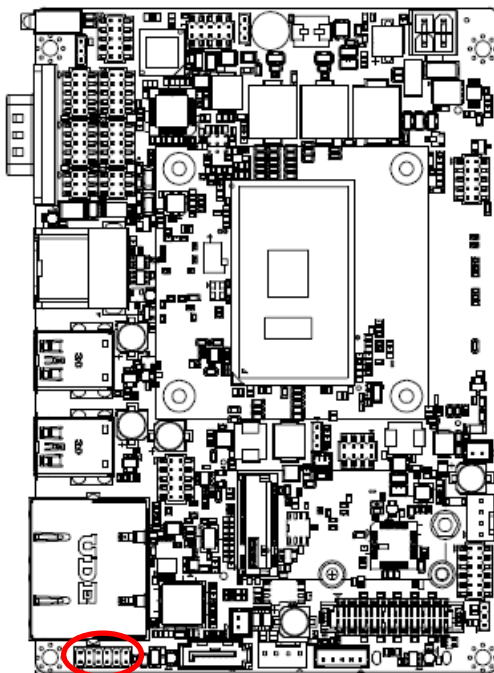

Signal	PIN	PIN	Signal
DIO_GP20	1	2	DIO_GP10
DIO_GP21	3	4	DIO_GP11
DIO_GP22	5	6	DIO_GP12
DIO_GP23	7	8	DIO_GP13
SMB_SCL_S0	9	10	SMB_SDA_S0
GND	11	12	+5V

2.3.11 SATA Power connector (SATA_PWR1)

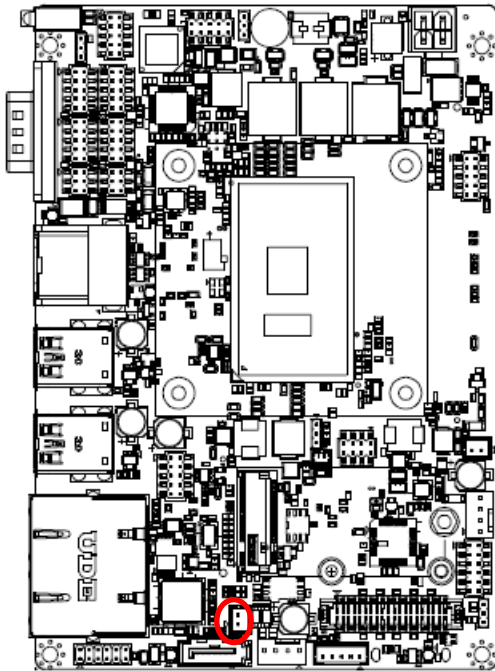

Signal	PIN
+5V	2
GND	1

2.3.12 Power connector (PWR1)

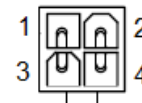
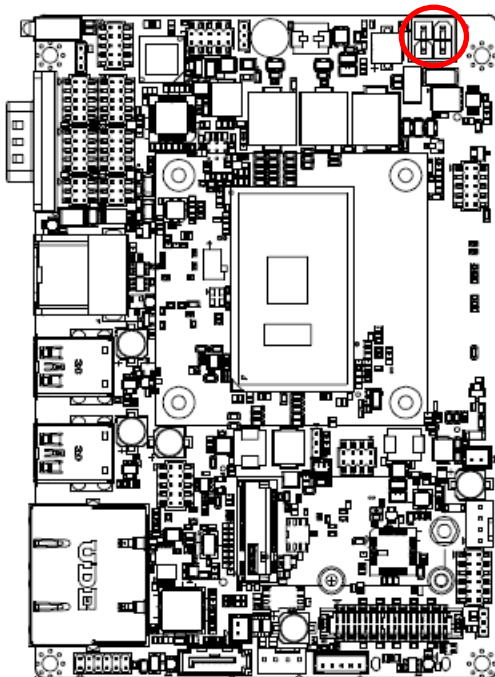

Signal	PIN	PIN	Signal
GND	1	2	GND
+26V	3	4	+26V

2.3.13 LVDS connector (JLVDS1)

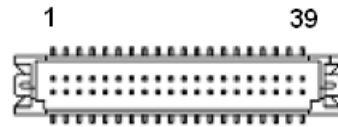
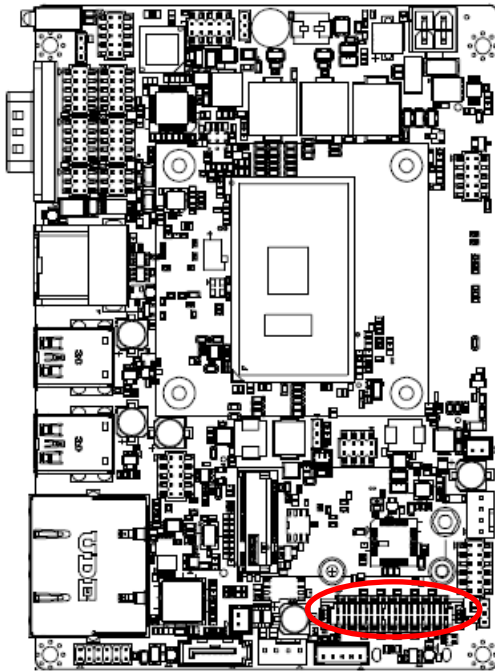

Signal	PIN	PIN	Signal
+3.3V	1	2	+5V
+3.3V	3	4	+5V
NC	5	6	NC
GND	7	8	GND
LVDS_DATA1_P	9	10	LVDS_DATA0_P
LVDS_DATA1_N	11	12	LVDS_DATA0_N
GND	13	14	GND
LVDS_DATA3_P	15	16	LVDS_DATA2_P
LVDS_DATA3_N	17	18	LVDS_DATA2_N
GND	19	20	GND
LVDS_DATA5_P	21	22	LVDS_DATA4_P
LVDS_DATA5_N	23	24	LVDS_DATA4_N
GND	25	26	GND
LVDS_DATA7_P	27	28	LVDS_DATA6_P
LVDS_DATA7_N	29	30	LVDS_DATA6_N
GND	31	32	GND
LVDS_CLK2_P	33	34	LVDS_CLK1_P
LVDS_CLK2_N	35	36	LVDS_CLK1_N
GND	37	38	GND
+12V	39	40	+12V

2.3.14 USB2.0 connector (JUSB56)

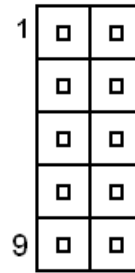
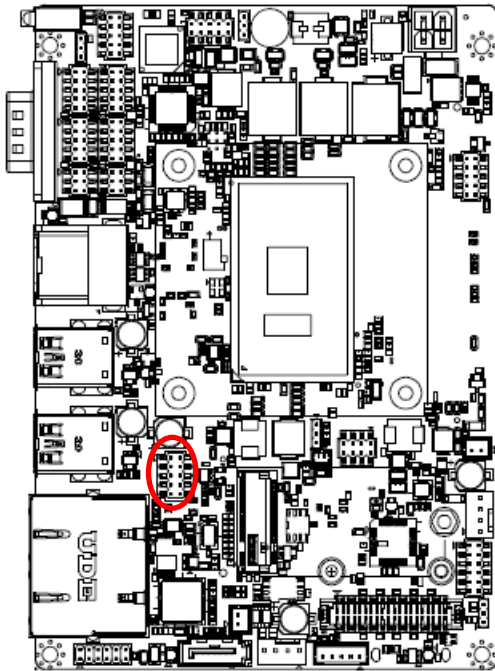

Signal	PIN	PIN	Signal
+5VSB	1	2	GND
USB_R_DN5	3	4	GND
USB_R_DP5	5	6	USB_R_DP6
GND	7	8	USB_R_DN6
GND	9	10	+5VSB

2.3.15 SPI connector (JSPI1)

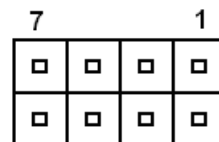
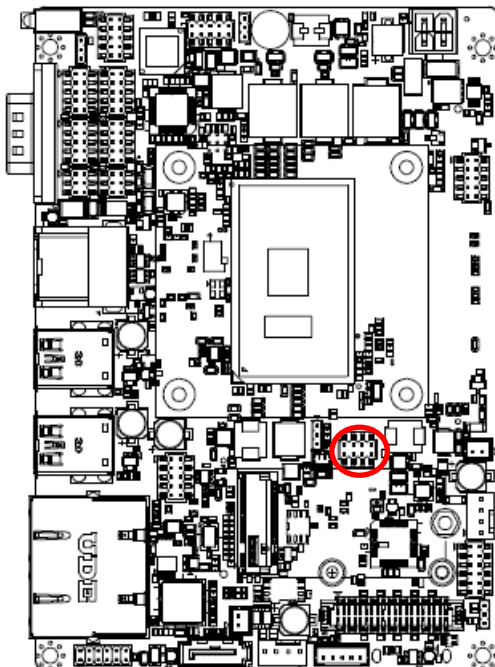

Signal	PIN	PIN	Signal
+3.3VSB	1	2	GND
SPI_CS0#	3	4	SPI_CLK
SPI_MISO	5	6	SPI_MOSI
BIOS_HOLD#	7	8	BIOS_WP#

2.3.16 EC Debug connector (JEC_ROM1)

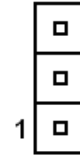
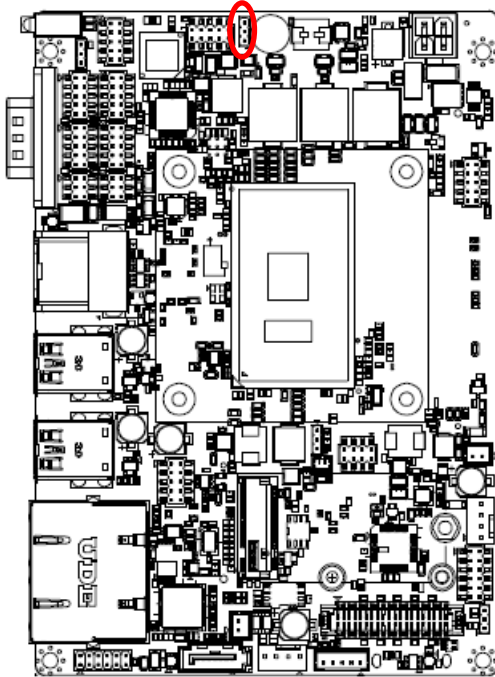

Signal	PIN
GND	3
EC_SMDAT_DEBUG	2
EC_SMCLK_DEBUG	1

2.3.17 Battery connector (BAT1)

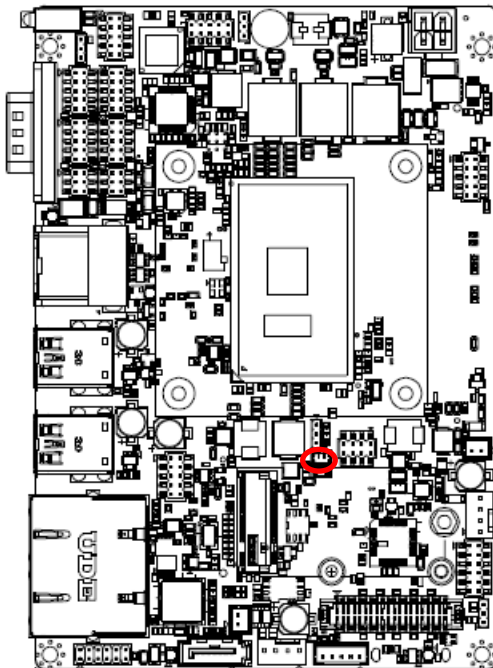

Signal	PIN
+RTCBAT	1
GND	2

2.3.18 LPC connector (JLPC1)

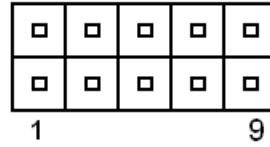
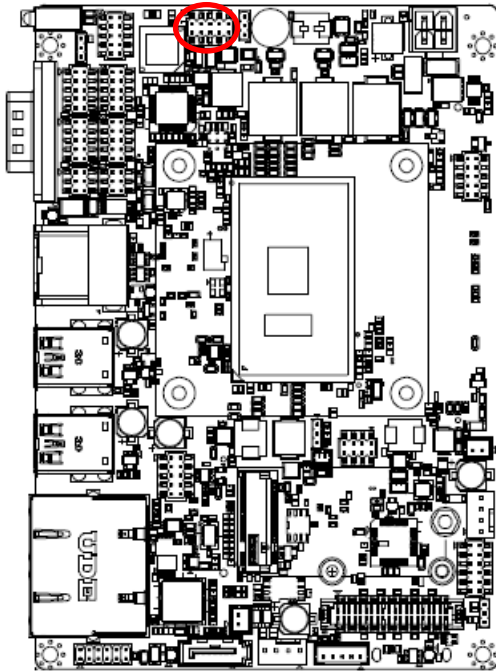

Signal	PIN	PIN	Signal
LPC_AD0	1	2	+3.3V
LPC_AD1	3	4	RST_TPM#
LPC_AD2	5	6	LPC_LFRAME#
LPC_AD3	7	8	CLK2_LPC_DEBUG
LPC_SERIRQ	9	10	GND

2.3.19 Front Panel connector (JFP1)

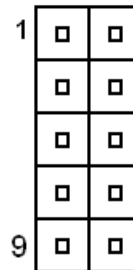
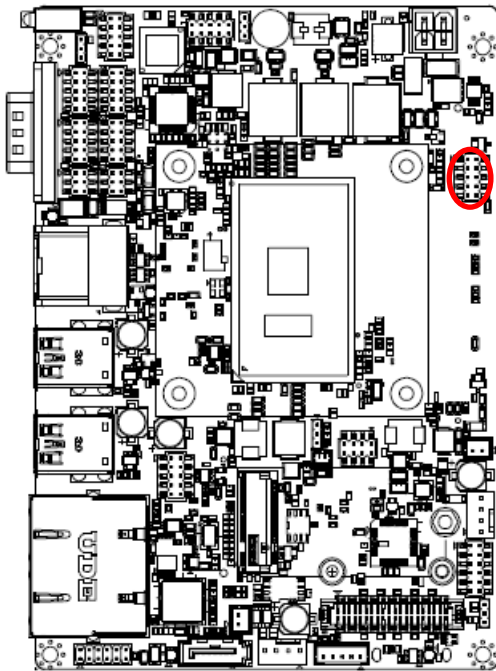

Signal	PIN	PIN	Signal
PWRBTN_TO_EC#	1	2	GND
PM_SYSRST#	3	4	GND
FP_PWR_LED+	5	6	PWR_LED#
HDD_LED#	7	8	+5V
CASE_OPEN#	9	10	GND

2.3.20 PC Buzzer connector (JBZ1)

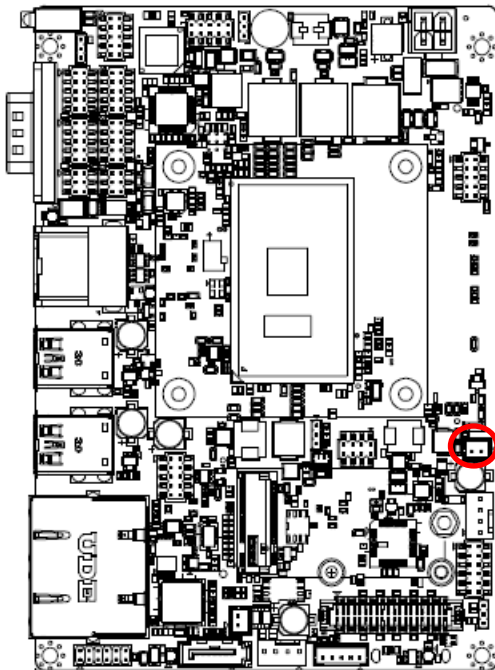

Signal	PIN
SOC_SPKR_R	1
+5V	2

2.3.21 AUDIO connector (JAUDIO1)

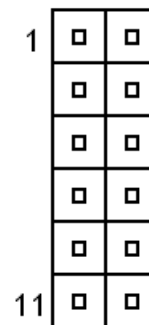
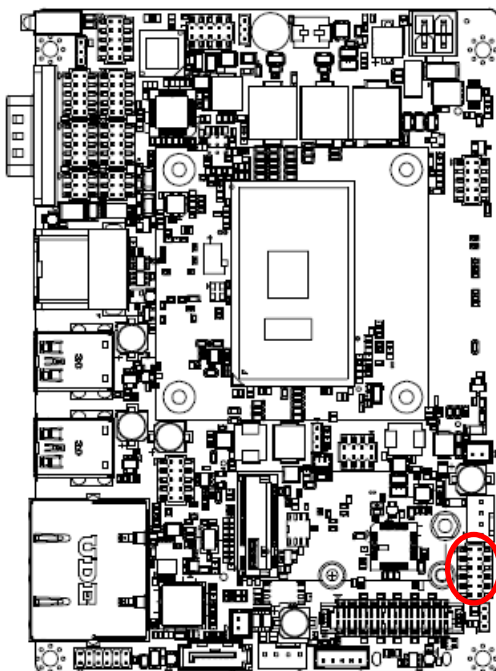

Signal	PIN	PIN	Signal
FRONT-R-OUT	1	2	FRONT-L-OUT
HD_AGND	3	4	HD_AGND
LINE1-R-IN	5	6	LINE1-L-IN
MIC1-R-IN	7	8	MIC1-L-IN
FRONT-JD	9	10	LINE1-JD
MIC1-JD	11	12	HD_AGND

2.3.21.1 Signal Description – Audio connector (JAUDIO1)

Signal	Signal Description
LINE1-JD	AUDIO IN (LINE_RIN/LIN)sense pin
FRONT-JD	AUDIO Out(ROUT/LOUT) sense pin
MIC1-JD	MIC IN (MIC_RIN/LIN) sense pin

2.4 AUX-032 User's Guide

2.4.1 Jumper and Connector Layout

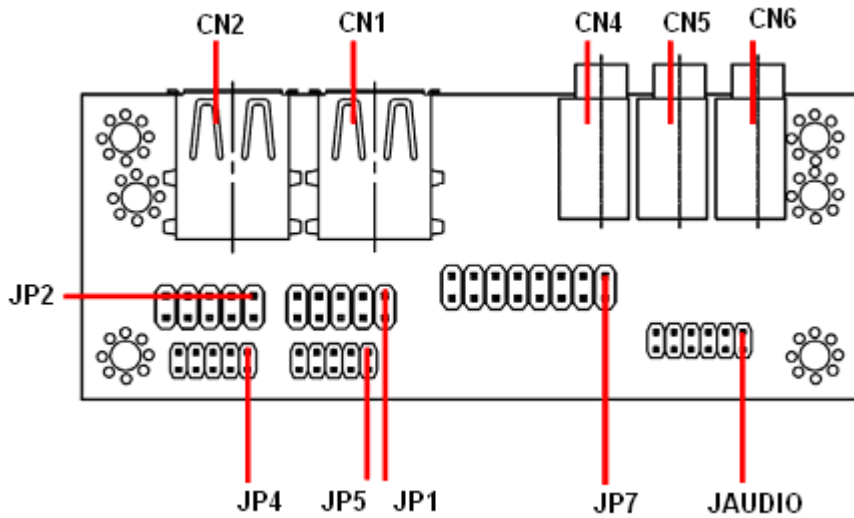

2.4.2 Jumper and Connector List

Connectors

Label	Function	Note
CN1/2	USB connector	
CN4	Line out connector	Phone Jack
CN5	Line in connector	Phone Jack
CN6	Mic in connector	Phone Jack
JAUDIO	Audio connector	6 x 2 header, pitch 2.0mm
JP1	2.54mm USB connector	5 x 2 header, pitch 2.54mm
JP2	2.54mm USB connector	5 x 2 header, pitch 2.54mm
JP4	2.0mm USB connector	5 x 2 header, pitch 2.0mm
JP5	2.0mm USB connector	5 x 2 header, pitch 2.0mm
JP7	TV / Audio connector	8 x 2 header, pitch 2.54mm

2.4.3 Setting Jumper and Connector

Audio Connector (JAUDIO)

Signal	PIN	PIN	Signal
OUTR	1	2	OUTL
GND	3	4	GND
INR1	5	6	INL1
MICIN1	7	8	AREF
FRONT-JD1	9	10	LINE1-JD1
MIC1-JD1	11	12	GND

2.54mm USB Connector (JP1)

Signal	PIN	PIN	Signal
+5V	1	2	GND
D1-	3	4	GND
D1+	5	6	D2+
GND	7	8	D2-
GND	9	10	+5V



Note: Wrong USB cable configuration with your USB devices might damage your USB devices.

2.54mm USB Connector (JP2)

Signal	PIN	PIN	Signal
+5V	1	2	GND
D3-	3	4	GND
D3+	5	6	D4+
GND	7	8	D4-
GND	9	10	+5V

TV / Audio Connector (JP7)

Signal	PIN	PIN	Signal
Mic In	1	2	Mic Bais
GND	3	4	GND
Line out L	5	6	Line out R
SPK L	7	8	SPK R
Line in L	9	10	Line in R
GND	11	12	NC
TVGND	13	14	NC
TVGND	15	16	COMP

2.0mm USB Connector (JP4)

Signal	PIN	PIN	Signal
+5V	1	2	GND
D3-	3	4	GND
D3+	5	6	D4+
GND	7	8	D4-
GND	9	10	+5V

2.0mm USB Connector (JP5)

Signal	PIN	PIN	Signal
+5V	1	2	GND
D1-	3	4	GND
D1+	5	6	D2+
GND	7	8	D2-
GND	9	10	+5V

2.5 Cooler installation

1. Please remove release paper.

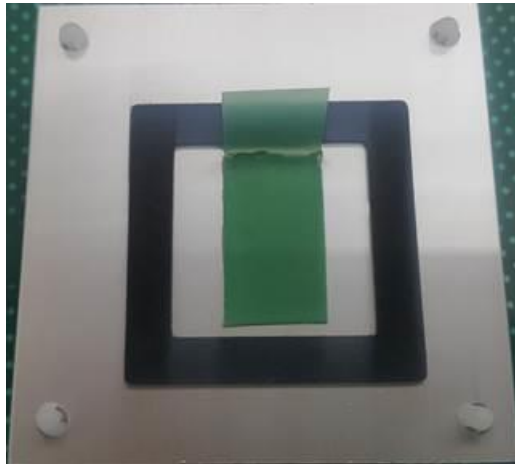

2. Please follow the below picture to install the cooler and cooler wire. And push down 4 screw of cooler and finish the installation.

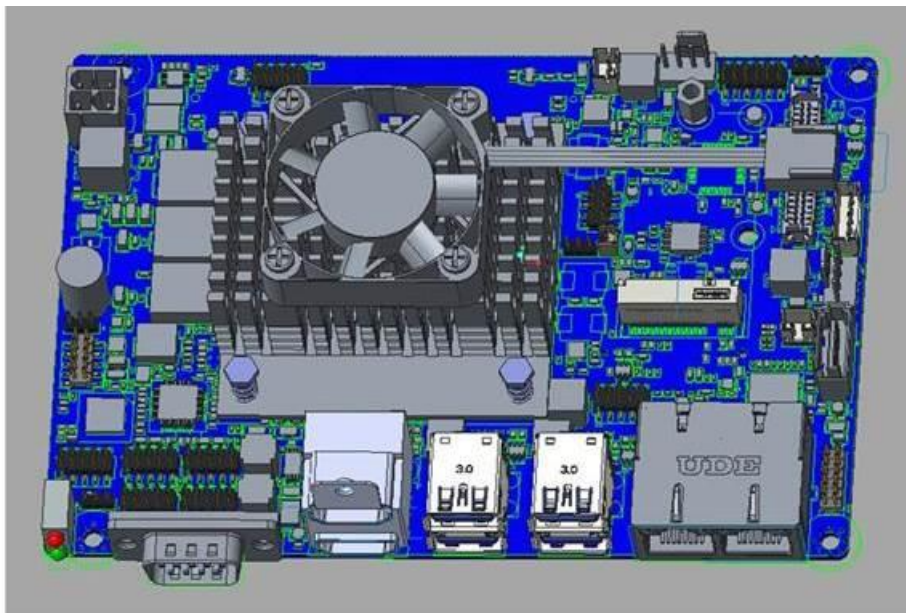

3. BIOS Setup

3.1 Introduction

The BIOS setup program allows users to modify the basic system configuration. In this following chapter will describe how to access the BIOS setup program and the configuration options that may be changed.

3.2 Starting Setup

AMI BIOS™ is immediately activated when you first power on the computer. The BIOS reads the system information contained in the NVRAM and begins the process of checking out the system and configuring it. When it finishes, the BIOS will seek an operating system on one of the disks and then launch and turn control over to the operating system.

While the BIOS is in control, the Setup program can be activated in one of two ways:

By pressing <ESC> or immediately after switching the system on, or

By pressing the <ESC> or key when the following message appears briefly at the left-top of the screen during the POST (Power On Self Test).

Press <ESC> or to enter SETUP

If the message disappears before you respond and you still wish to enter Setup, restart the system to try again by turning it OFF then ON or pressing the "RESET" button on the system case. You may also restart by simultaneously pressing <Ctrl>, <Alt>, and <Delete> keys.

3.3 Using Setup

In general, you use the arrow keys to highlight items, press <Enter> to select, use the PageUp and PageDown keys to change entries, press <F1> for help and press <Esc> to quit. The following table provides more detail about how to navigate in the Setup program using the keyboard.

Button	Description
↑	Move to previous item
↓	Move to next item
←	Move to the item in the left hand
→	Move to the item in the right hand
Esc key	Main Menu -- Quit and not save changes into NVRAM Status Page Setup Menu and Option Page Setup Menu -- Exit current page and return to Main Menu
+ key	Increase the numeric value or make changes
- key	Decrease the numeric value or make changes
F1 key	General help, only for Status Page Setup Menu and Option Page Setup Menu
F2 key	Previous Values
F3 key	Optimized defaults
F4 key	Save & Exit Setup

- **Navigating Through The Menu Bar**

Use the left and right arrow keys to choose the menu you want to be in.



Note: Some of the navigation keys differ from one screen to another.

- **To Display a Sub Menu**

Use the arrow keys to move the cursor to the sub menu you want. Then press <Enter>. A “➤” pointer marks all sub menus.

3.4 Getting Help

Press F1 to pop up a small help window that describes the appropriate keys to use and the possible selections for the highlighted item. To exit the Help Window press <Esc> or the <Enter> key again.

3.5 In Case of Problems

If, after making and saving system changes with Setup, you discover that your computer no longer is able to boot, the AMI BIOS supports an override to the NVRAM settings which resets your system to its defaults.

The best advice is to only alter settings which you thoroughly understand. To this end, we strongly recommend that you avoid making any changes to the chipset defaults. These defaults have been carefully chosen by both BIOS Vendor and your systems manufacturer to provide the absolute maximum performance and reliability. Even a seemingly small change to the chipset setup has the potential for causing you to use the override.

3.6 BIOS setup

Once you enter the Aptio Setup Utility, the Main Menu will appear on the screen. The Main Menu allows you to select from several setup functions and exit choices. Use the arrow keys to select among the items and press <Enter> to accept and enter the sub-menu.

3.6.1 Main Menu

This section allows you to record some basic hardware configurations in your computer and set the system clock.

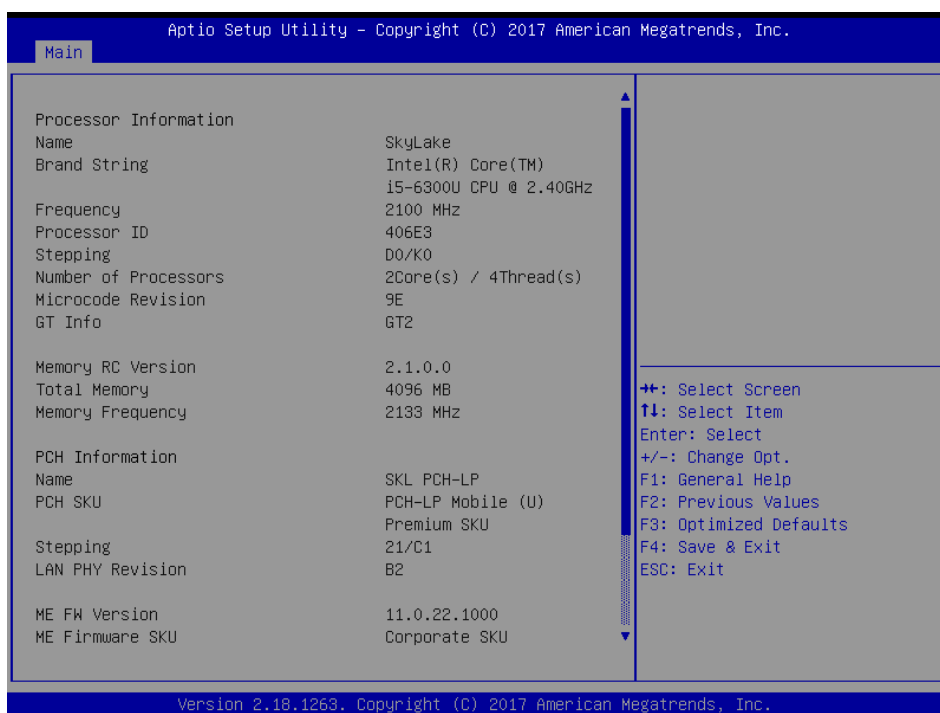
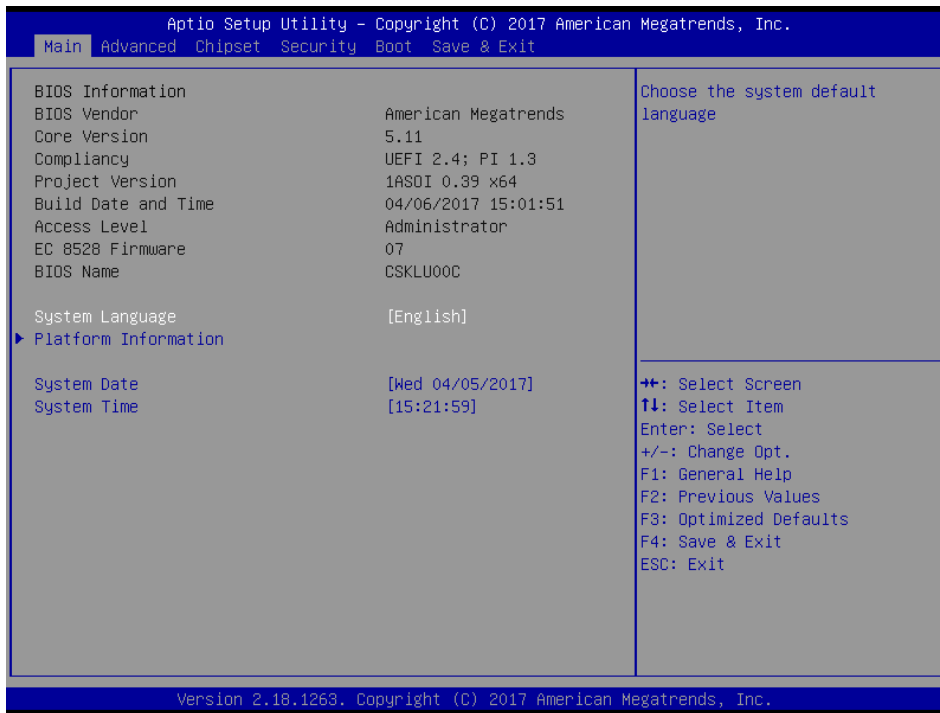

ECM-SKLU User's Manual

3.6.1.1 System Language

This option allows choosing the system default language.

3.6.1.2 System Date

Use the system date option to set the system date. Manually enter the day, month and year.

3.6.1.3 System Time

Use the system time option to set the system time. Manually enter the hours, minutes and seconds.



Note: The BIOS setup screens shown in this chapter are for reference purposes only, and may not exactly match what you see on your screen.

Visit the Avalue website (www.avalue.com.tw) to download the latest product and BIOS information.

3.6.2 Advanced Menu

This section allows you to configure your CPU and other system devices for basic operation through the following sub-menus.

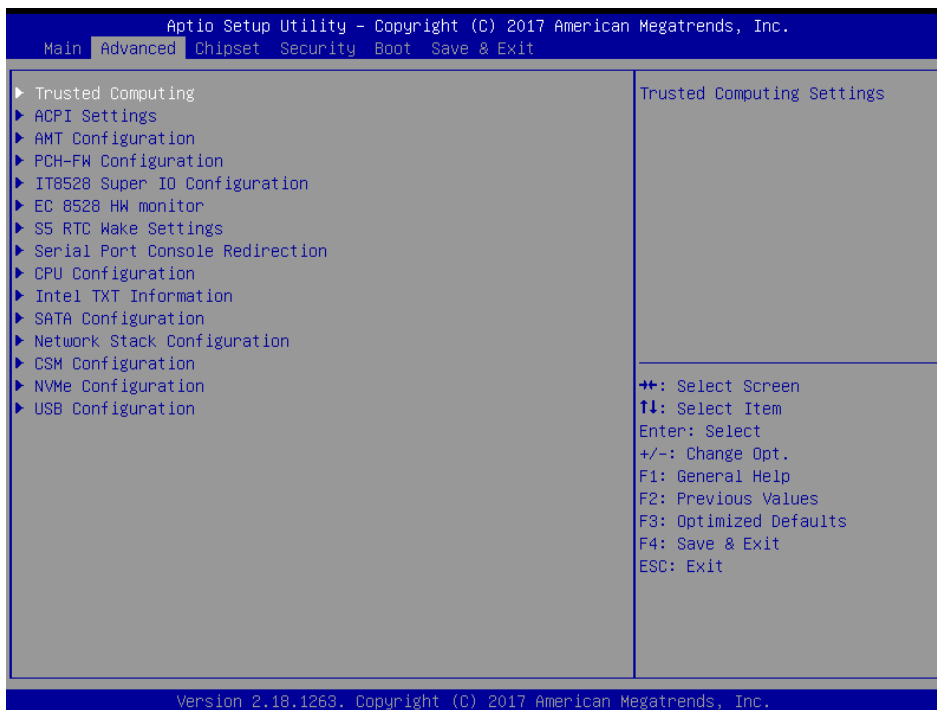

3.6.2.1 Trusted Computing

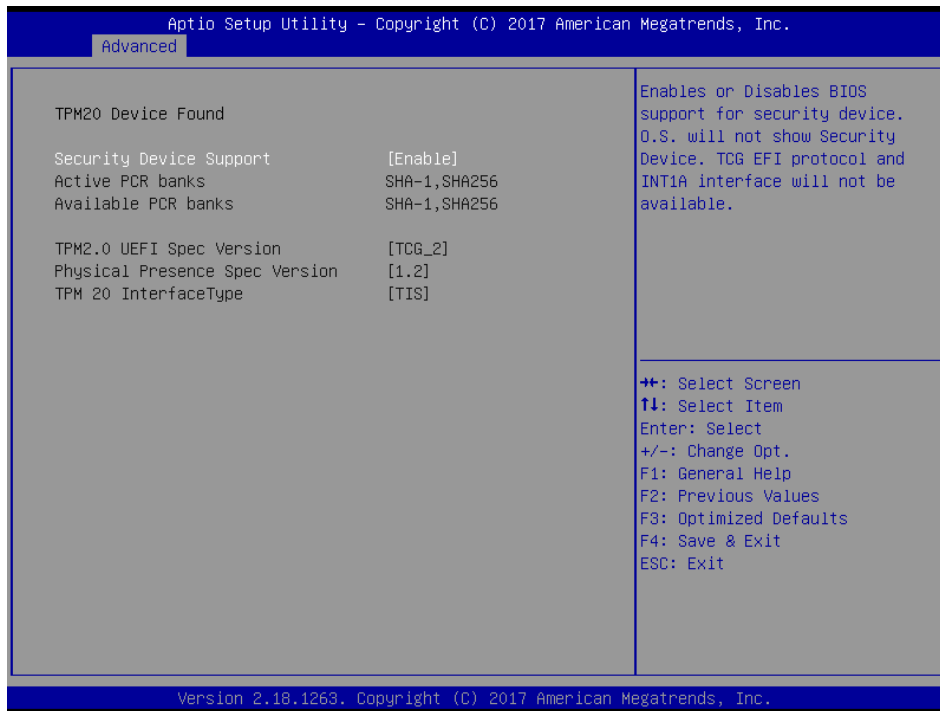

Item	Options	Description
Security Device Support	Disable, Enable[Default]	Enables or Disables BIOS support for security device. O.S. will not show Security Device. TCG EFI protocol and INT1A interface will not be available.

3.6.2.2 ACPI Settings



ECM-SKLU User's Manual

Item	Options	Description
Enable Hibernation	Disabled Enabled[Default],	Enables or Disables System ability to Hibernate (OS/S4 Sleep State). This option may be not effective with some OS.
ACPI Sleep State	Suspend Disabled, S3 (Suspend to RAM) [Default]	Select the highest ACPI sleep state the system will enter when the SUSPEND button is pressed.
ACPI Low Power S0 Idle	Disabled[Default], Enabled	Enable or Disable ACPI Low Power S0 Idle Support.
ErP Function	Disabled[Default], Enabled	ErP Function (Deep S5).
PWR-On After PWR-Fail	Off[Default] On Last state	AC loss resume.
Watch Dog	Disabled[Default], 30 sec 40 sec 50 sec 1 min 2 min 10 min 30 min	Select WatchDog.
USB Standby Power Setting	Disabled Enabled[Default],	Enabled/Disabled USB Standby Power during S3/S4/S5.

3.6.2.3 AMT Configuration

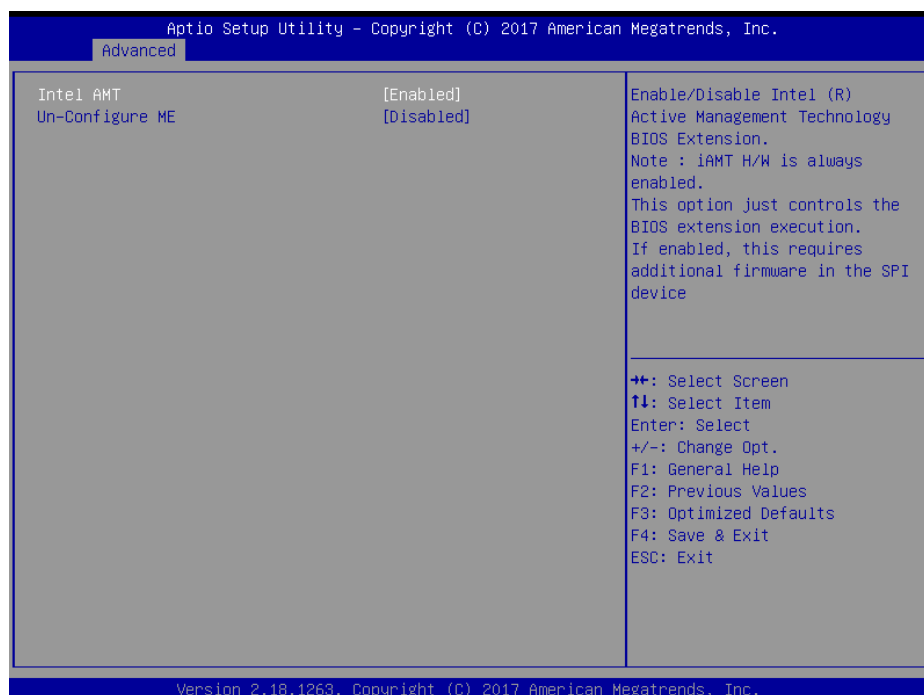

Item	Options	Description
Intel AMT	Disabled Enabled[Default],	Enable/Disable Intel® Active Management Technology BIOS Extension. Note: iAMT H/W is always enabled. This option just controls the BIOS extension execution. If enabled, this requires additional firmware in the SPI device.
Un-Configure ME	Disabled[Default] Enabled,	OEMFlag Bit 15: Un-Configure ME without password.

3.6.2.4 PCH-FW Configuration

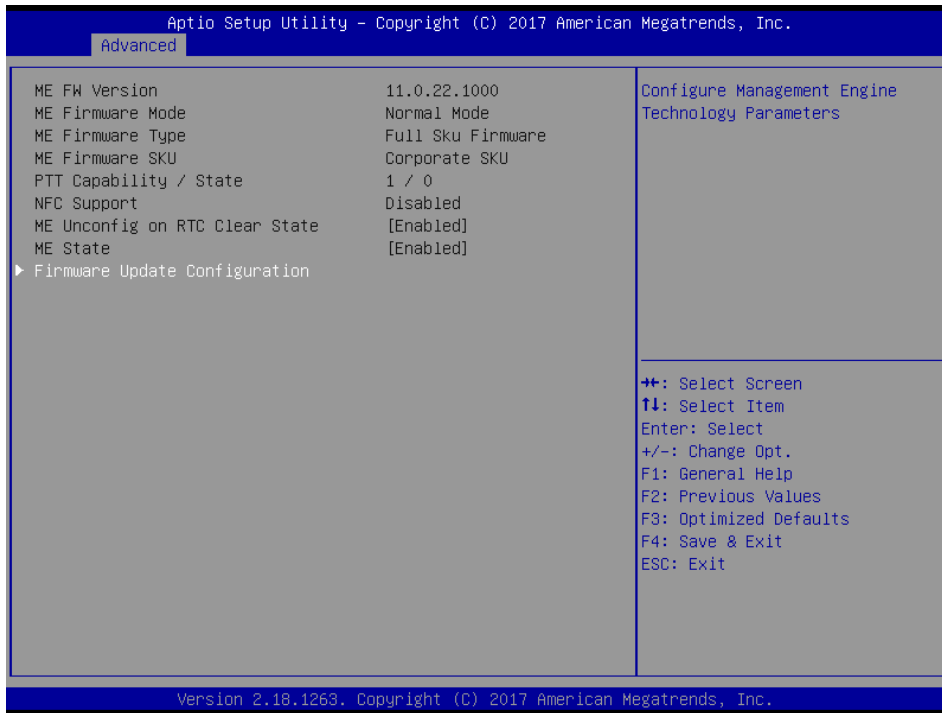

ECM-SKLU User's Manual

3.6.2.4.1 Firmware Update Configuration



Item	Option	Description
ME FW Image Re-Flash	Disabled [Default], Enabled	Enable/Disable Me FW Image Re-Flash function.

3.6.2.5 IT8528 Super IO Configuration

You can use this item to set up or change the IT8528 Super IO configuration for serial ports. Please refer to 3.6.2.5.1~ 3.6.2.5.6 for more information.

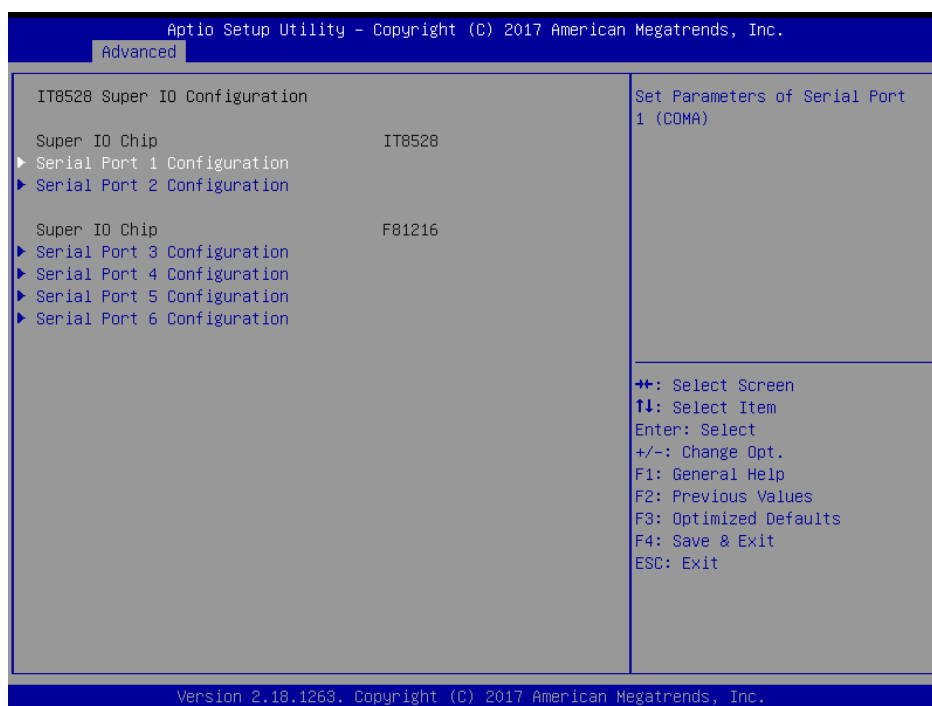

Item	Description
Serial Port 1 Configuration	Set Parameters of Serial Port 1 (COMA).
Serial Port 2 Configuration	Set Parameters of Serial Port 2 (COMB).
Serial Port 3 Configuration	Set Parameters of Serial Port 3 (COMC).
Serial Port 4 Configuration	Set Parameters of Serial Port 4 (COMD).
Serial Port 5 Configuration	Set Parameters of Serial Port 5 (COME).
Serial Port 6 Configuration	Set Parameters of Serial Port 6 (COMF).

3.6.2.5.1 Serial Port 1 Configuration

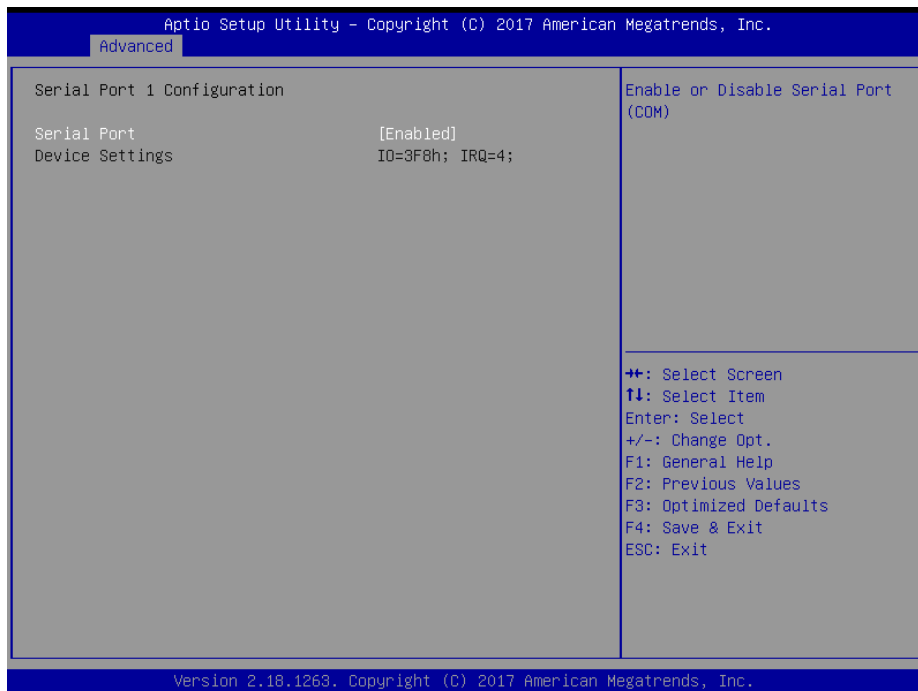

Item	Option	Description
Serial Port	Enabled[Default], Disabled	Enable or Disable Serial Port (COM).

3.6.2.5.2 Serial Port 2 Configuration

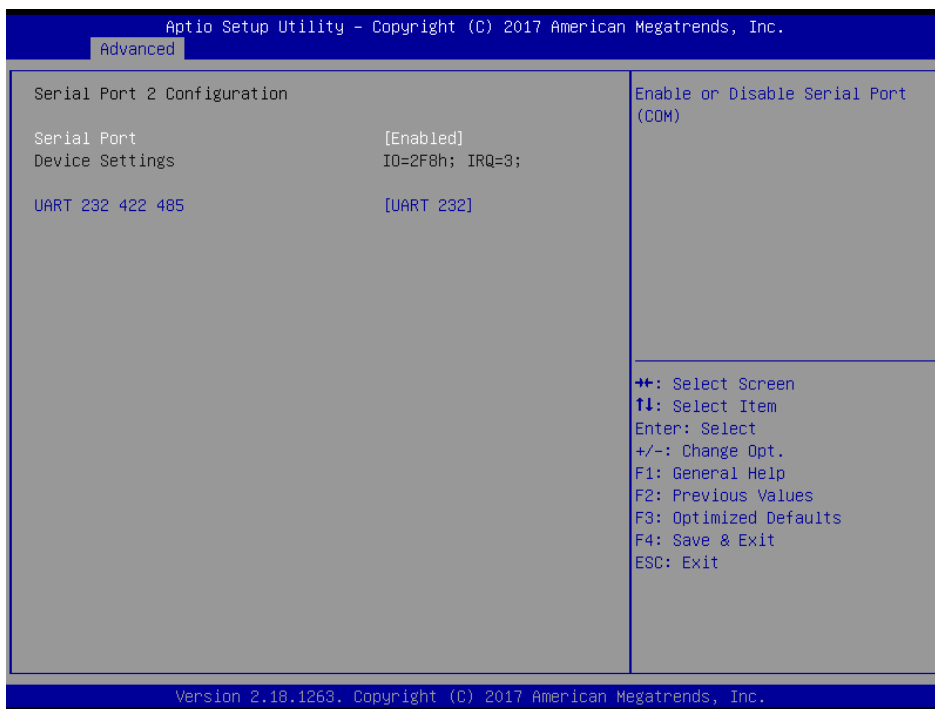

Item	Option	Description
Serial Port	Enabled[Default], Disabled	Enable or Disable Serial Port (COM).
UART 232 422 485	UART 232[Default] UART 422 UART 485	Change the Serial Port as RS232/422/485.

3.6.2.5.3 Serial Port 3 Configuration

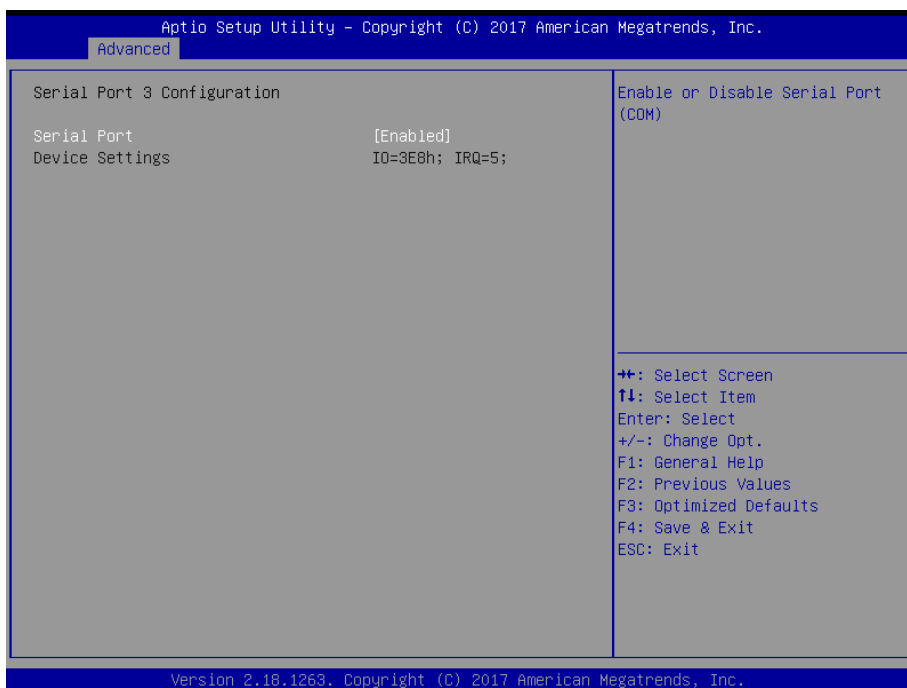

Item	Option	Description
Serial Port	Enabled[Default], Disabled	Enable or Disable Serial Port (COM).

3.6.2.5.4 Serial Port 4 Configuration

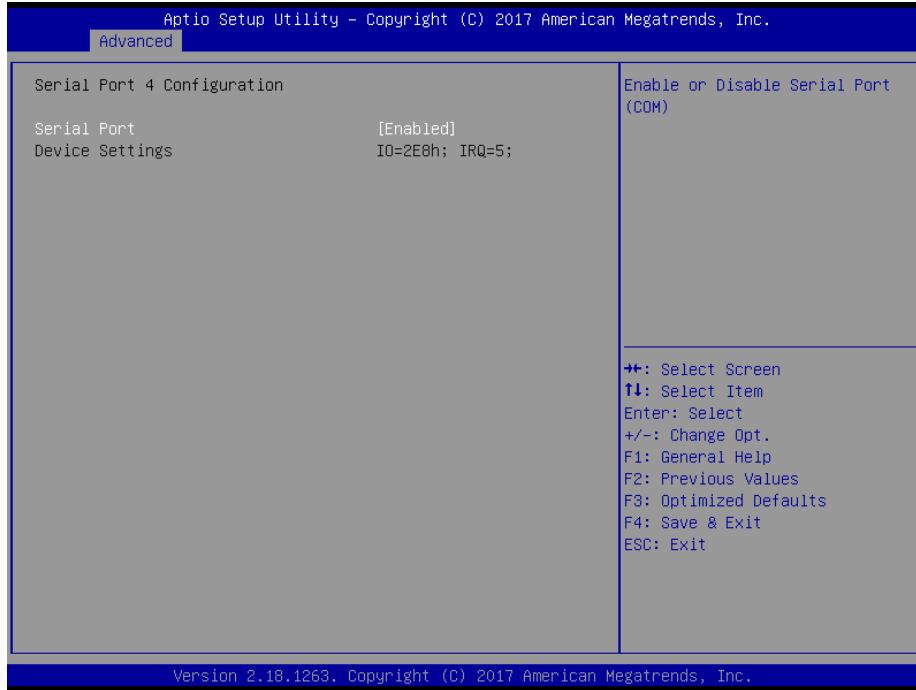

Item	Option	Description
Serial Port	Enabled[Default], Disabled	Enable or Disable Serial Port (COM).

3.6.2.5.5 Serial Port 5 Configuration

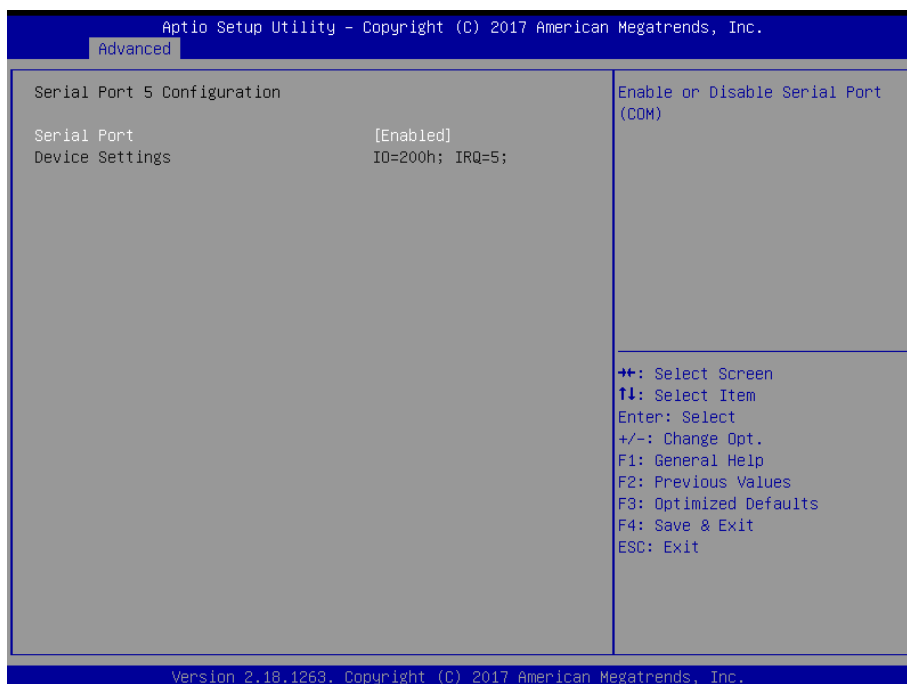

ECM-SKLU User's Manual

Item	Option	Description
Serial Port	Enabled[Default], Disabled	Enable or Disable Serial Port (COM).

3.6.2.5.6 Serial Port 6 Configuration

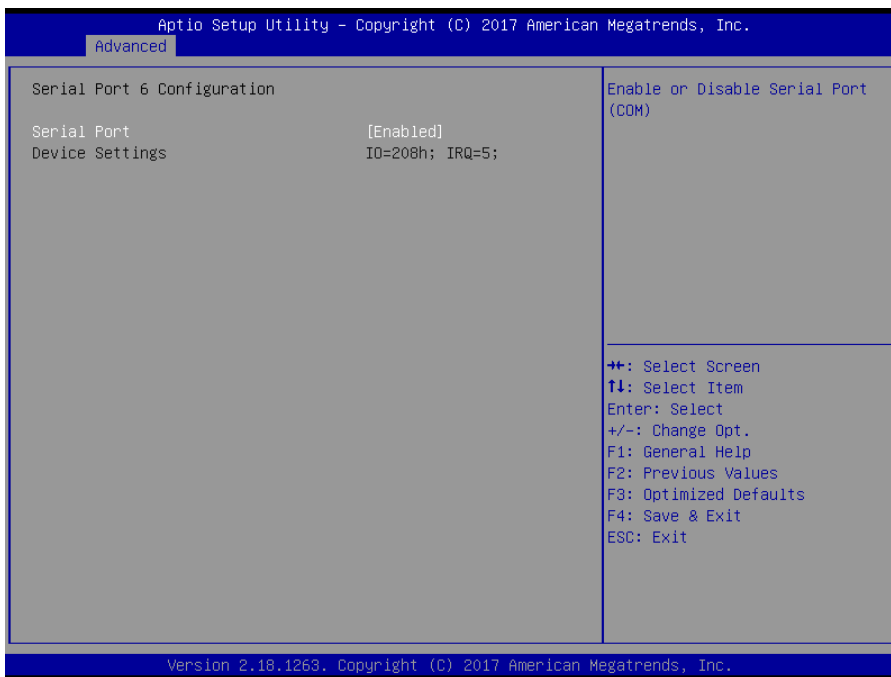

Item	Option	Description
Serial Port	Enabled[Default], Disabled	Enable or Disable Serial Port (COM).

3.6.2.6 H/W Monitor



Item	Options	Description
Smart Fan Function	Enabled, Disabled[Default]	Enables or Disables Smart Fan.

3.6.2.7 S5 RTC Wake Settings

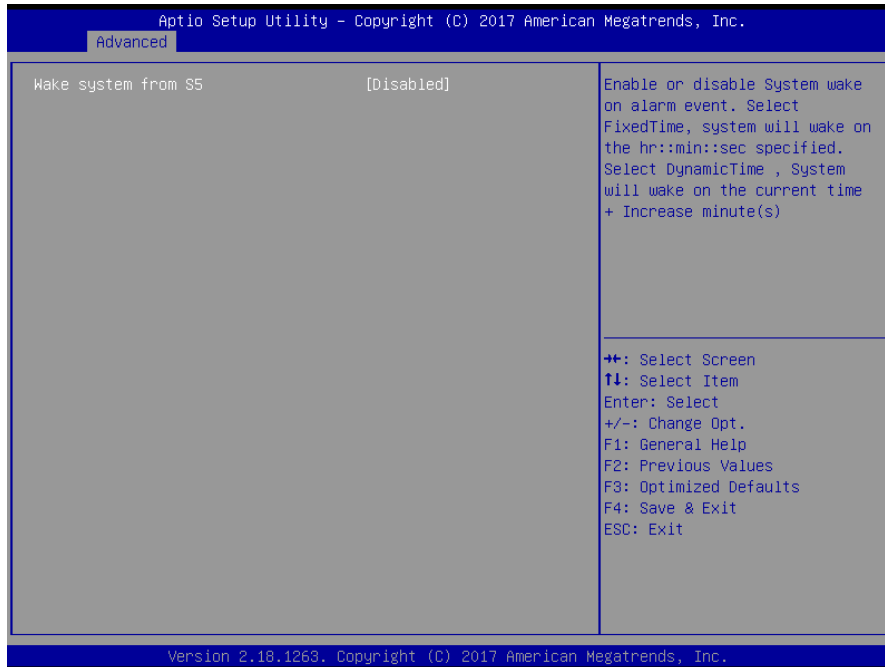

Item	Options	Description
Wake system from S5	Disabled[Default], Fixed Time Dynamic Time	Enable or disable System wake on alarm event. Select Fixed Time, system will wake on the hr::min::sec specified. Select Dynamic Time, System will wake on the current time + Increase minute(s).

3.6.2.8 Serial Port Console Redirection

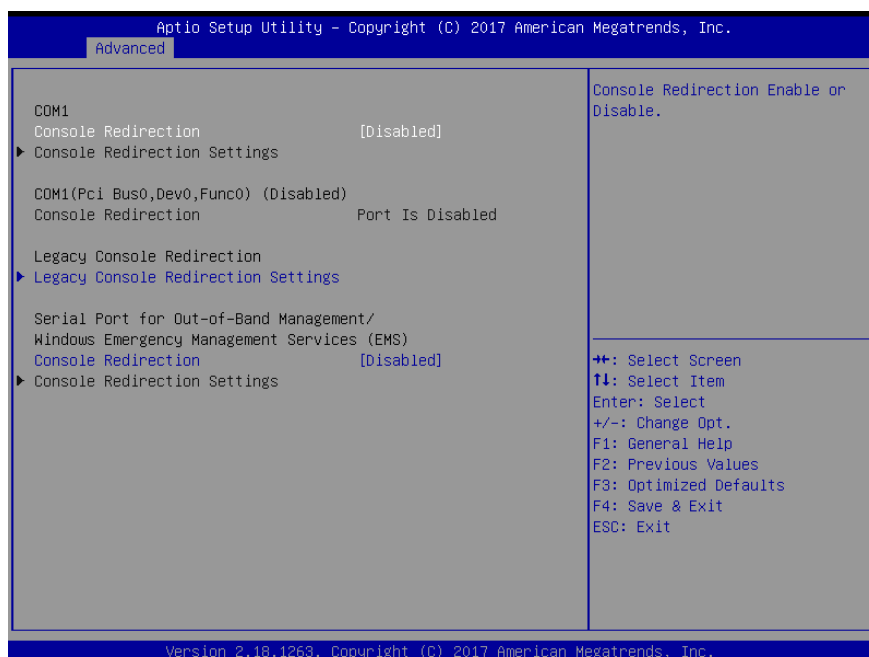

ECM-SKLU User's Manual

Item	Options	Description
Console Redirection	Disabled[Default], Enabled	Console Redirection Enable or Disable.

3.6.2.8.1 Legacy Console Redirection Settings



Item	Option	Description
Legacy Serial Redirection	COM1[Default], COM1(Pci Bus0, Dev0, Func0) (Disabled)	Select a COM port to display redirection of Legacy OS and Legacy OPRM Messages.

3.6.2.9 CPU Configuration

Use the CPU configuration menu to view detailed CPU specification and configure the CPU.

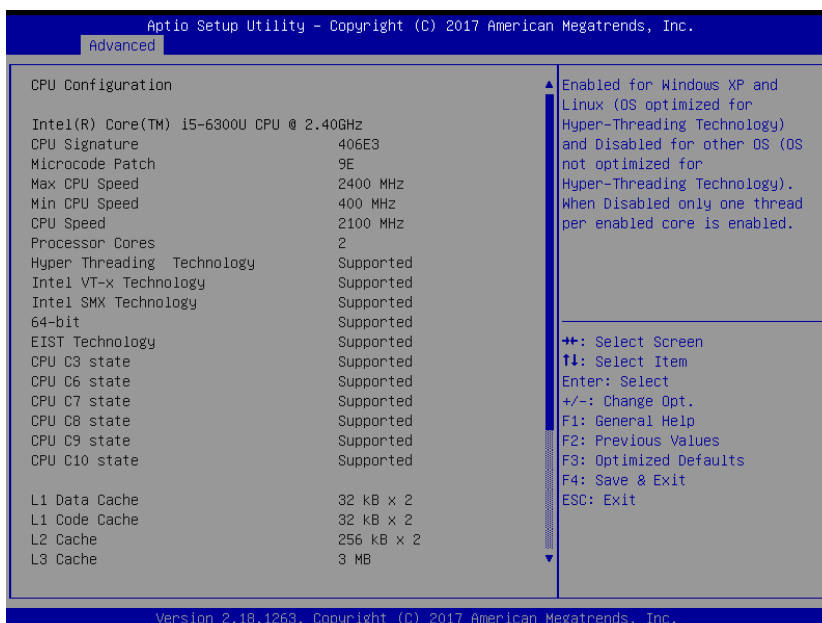

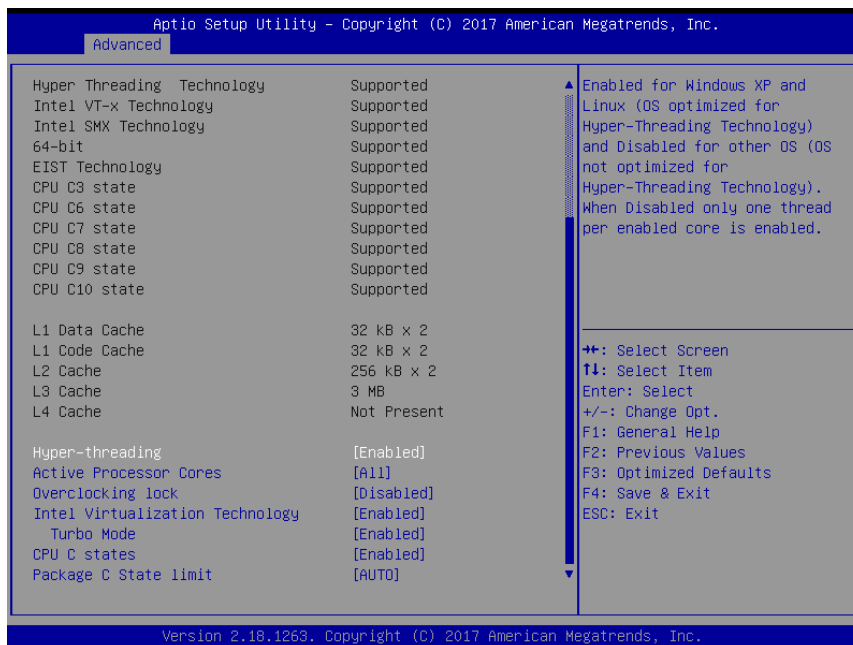

Item	Options	Description
Hyper-threading	Disabled, Enabled[Default]	Enabled for Windows XP and Linux (OS optimized for Hyper-Threading Technology) and Disabled for other OS (OS not optimized for Hyper-Threading Technology). When Disabled only one thread per enabled core is enabled.
Active Processor Cores	All[Default] 1	Number of cores to enable in each processor package.
Overclocking lock	Disabled[Default], Enabled	FLEX_RATIO(194) MSR.
Intel Virtualization Technology	Disabled, Enabled[Default]	When enabled, a VMM can utilize the additional hardware capabilities provided by Vanderpool Technology.
Turbo Mode	Disabled, Enabled[Default]	Turbo Mode.
CPU C states	Disabled, Enabled[Default]	Enable or disable CPU C states.
Package C State limit	C0/C1 C2 C3 C6 C7 C7s C8 C9 C10 AUTO[Default]	Package C State limit.

3.6.2.10 Intel TXT Configuration

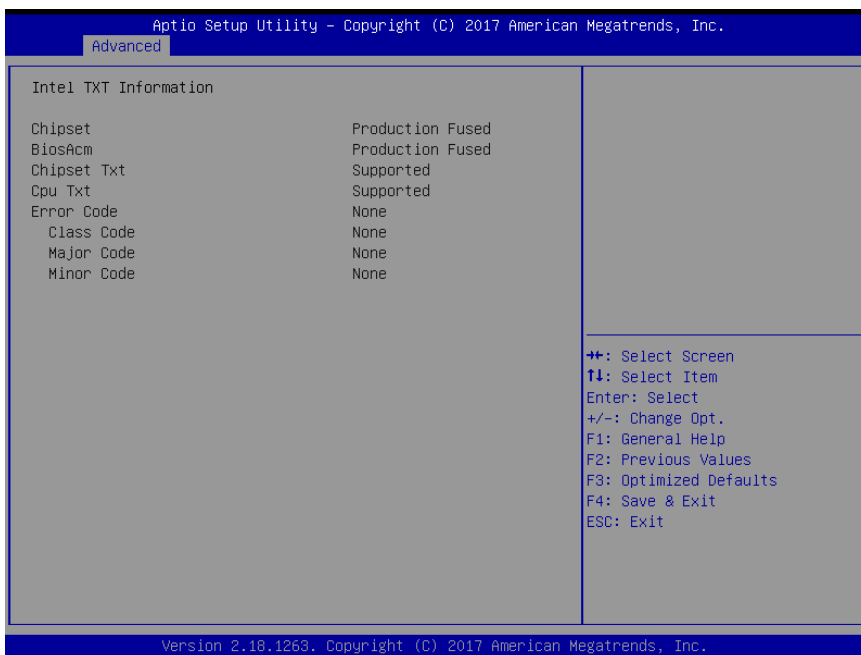

3.6.2.11 SATA Configuration

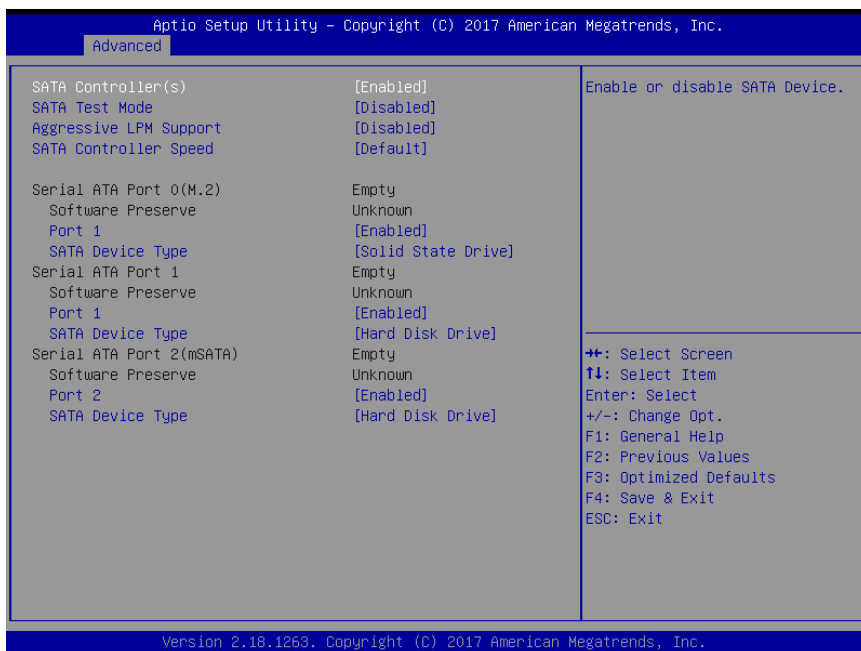

Item	Options	Description
SATA Controller(s)	Enabled[Default] Disabled,	Enable or disable SATA Device.
SATA Test Mode	Enabled Disabled[Default],	Test Mode Enable/Disable (Loop Back).
Aggressive LPM Support	Enabled Disabled[Default]	Enable PCH to aggressively enter link power state.

SATA Controller Speed	Default[Default] Gen1 Gen2 Gen3	Indicates the maximum speed the SATA controller can support.
------------------------------	--	--

Serial ATA Port 0(M.2)

Port 1	Enabled[Default] Disabled,	Enable or Disable SATA Port.
SATA Device Type	Hard Disk Drive Solid State Drive[Default]	Identify the SATA port is connected to Solid State Drive or Hard Disk Drive.

Serial ATA Port 1

Port 1	Enabled[Default] Disabled,	Enable or Disable SATA Port.
SATA Device Type	Hard Disk Drive[Default] Solid State Drive	Identify the SATA port is connected to Solid State Drive or Hard Disk Drive.

Serial ATA Port 2(mSATA)

Port 2	Enabled[Default] Disabled,	Enable or Disable SATA Port.
SATA Device Type	Hard Disk Drive[Default] Solid State Drive	Identify the SATA port is connected to Solid State Drive or Hard Disk Drive.

3.6.2.12 Network Stack Configuration



ECM-SKLU User's Manual

Item	Options	Description
Network Stack	Enabled Disabled[Default]	Enable/Disable UEFI Network Stack.

3.6.2.13 CSM Configuration



Item	Options	Description
CSM Support	Enabled Disabled[Default]	Enable/Disable CSM Support.

3.6.2.14 NVMe Configuration

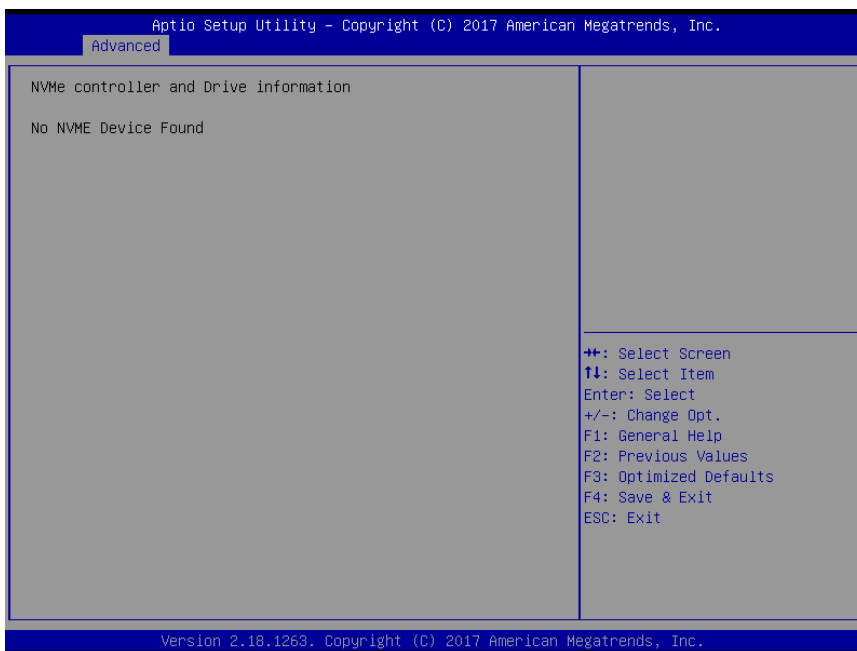

3.6.2.15 USB Configuration

The USB Configuration menu helps read USB information and configures USB settings.

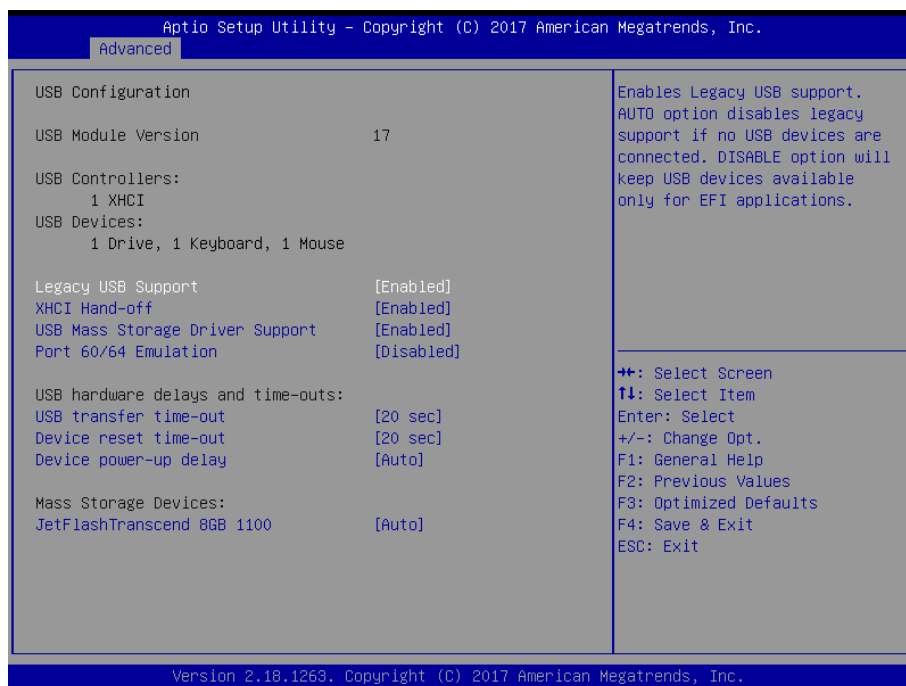

Item	Options	Description
Legacy USB Support	Enabled[Default] Disabled Auto	Enables Legacy USB support. AUTO option disables legacy support if no USB devices are connected. DISABLE option will keep USB devices available only for EFI applications.
XHCI Hand-off	Enabled[Default] Disabled	This is a workaround for OSeW without XHCI hand-off support. The XHCI ownership change should be claimed by XHCI driver.
USB Mass Storage Driver Support	Enabled[Default] Disabled	Enable/Disable USB Mass Storage Driver Support.
Port 60/64 Emulation	Enabled Disabled[Default]	Enable I/O port 60h/64h emulation support. This should be enabled for the complete USB keyboard legacy support for non-USB aware OSes.
USB transfer time-out	1 sec 5 sec 10 sec 20 sec[Default]	The time-out value for Control, Bulk, and Interrupt transfers.
Device reset time-out	10 sec 20 sec[Default] 30 sec 40 sec	USB mass storage device Start Unit command time-out.
Device power-up delay	Auto[Default] Manual	Maximum time the device will take before it properly reports itself to the Host Controller. 'Auto' uses default value: for a Root port it is 100ms, for a Hub port the delay is taken from Hub descriptor.

3.6.3 Chipset



3.6.3.1 System Agent (SA) Configuration

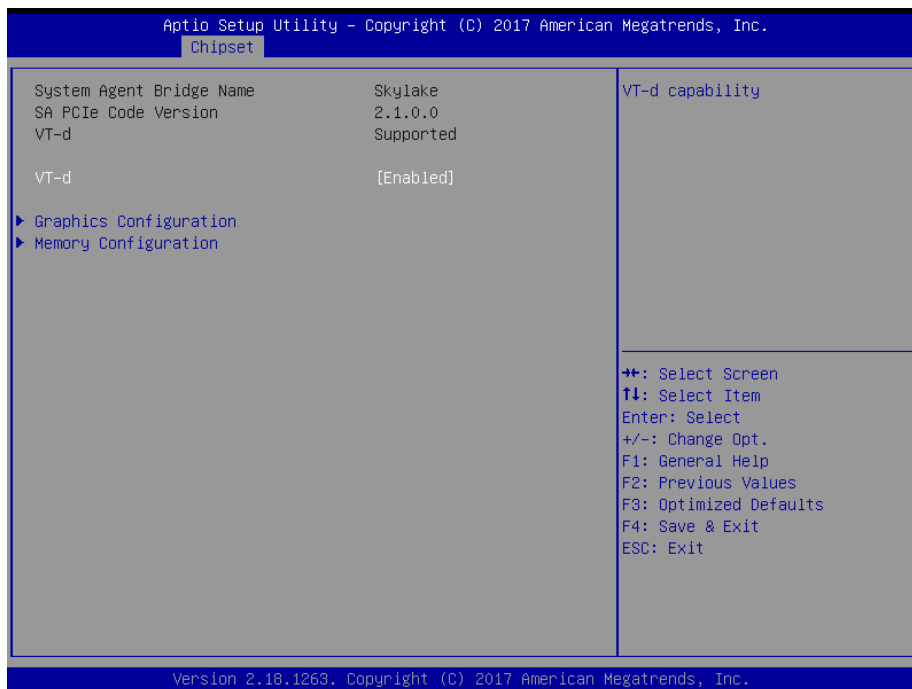

Item	Option	Description
VT-d	Enabled[Default] Disabled	VT-d capability.

3.6.3.1.1 Graphics Configuration

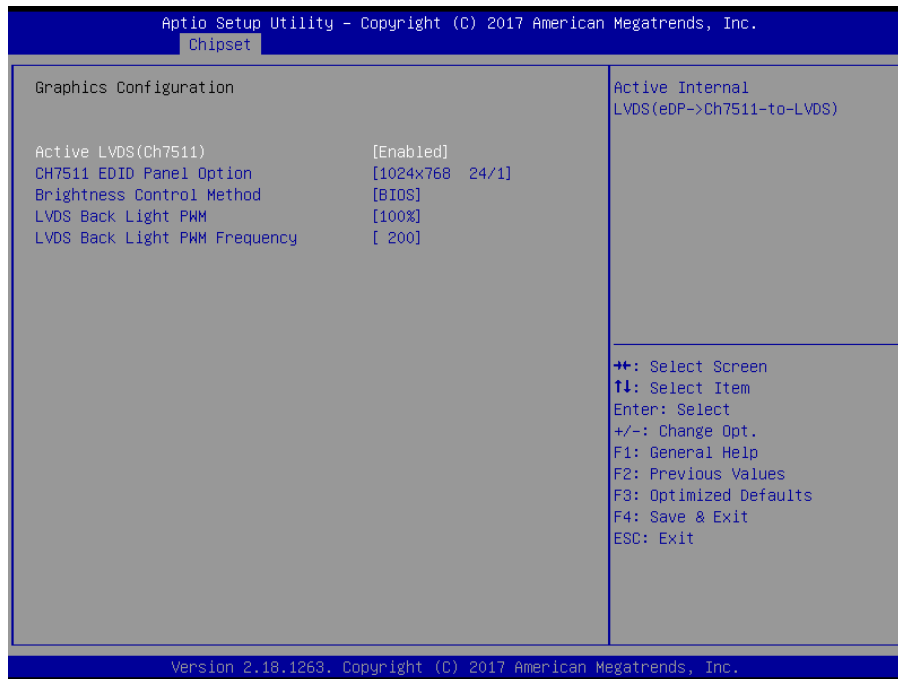

Item	Option	Description
Active LVDS(Ch7511)	Enabled[Default] Disabled	Active Internal LVDS (eDP->Ch7511-to-LVDS).
CH7511 EDID Panel Option	1024x768 24/1[Default] 800x600 18/1 1024x768 18/1 1366x768 18/1 1024x600 18/1 1280x800 18/1 1920x1200 24/2 1920x1080 18/2 1280x1024 24/2 1440x900 18/2 1600x1200 24/2 1366x768 24/1 1920x1080 24/2 1680x1050 24/2	Port1-EDP to LVDS (Chrotel 7511) Panel EDID Option.
Brightness Control Method	BIOS[Default] BR Button VR OS Driver	LVDS Brightness Control Method. 1.BIOS 2.Brightness Button 3.Variable Resistor 4.OS Driver.
LVDS Back Light PWM	00% 25% 50% 75% 100%[Default]	Select LVDS back light PWM duty.
LVDS Back Light PWM Frequency	200[Default] 300	Select LVDS back light PWM Frequency.

ECM-SKLU User's Manual

	400	
	500	
	700	
	1k	
	2k	
	3k	
	5k	
	10k	
	20k	

3.6.3.1.2 Memory Configuration

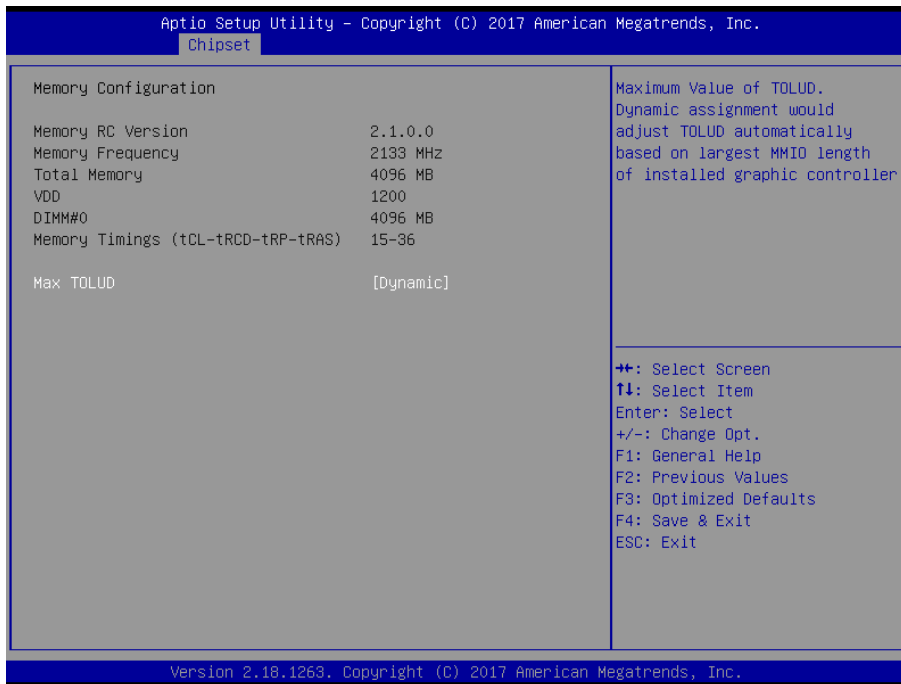

Item	Option	Description
Max TOLUD	Dynamic[Default] 1GB/1.25GB/1.5GB/1.75GB /2GB/2.25GB/2.5GB/2.75GB	Maximum Value of TOLUD. Dynamic assignment would adjust TOLUD automatically based on largest MMIO length of installed graphic controller.

3.6.3.2 PCH-IO Configuration

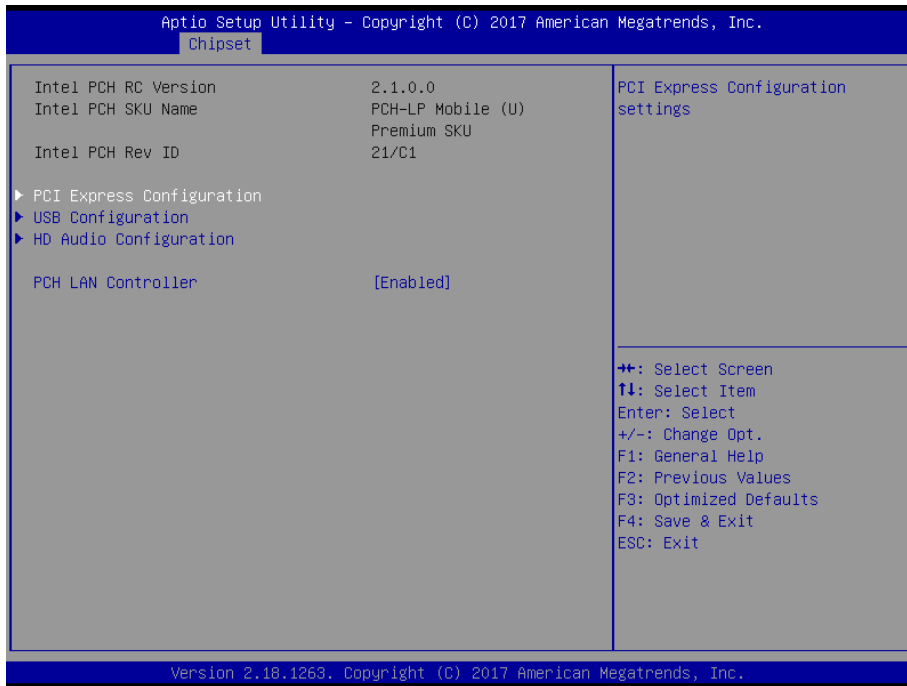

Item	Option	Description
PCH LAN Controller	Disabled Enabled[Default]	Enable or disable onboard NIC.

3.6.3.2.1 PCI Express Configuration

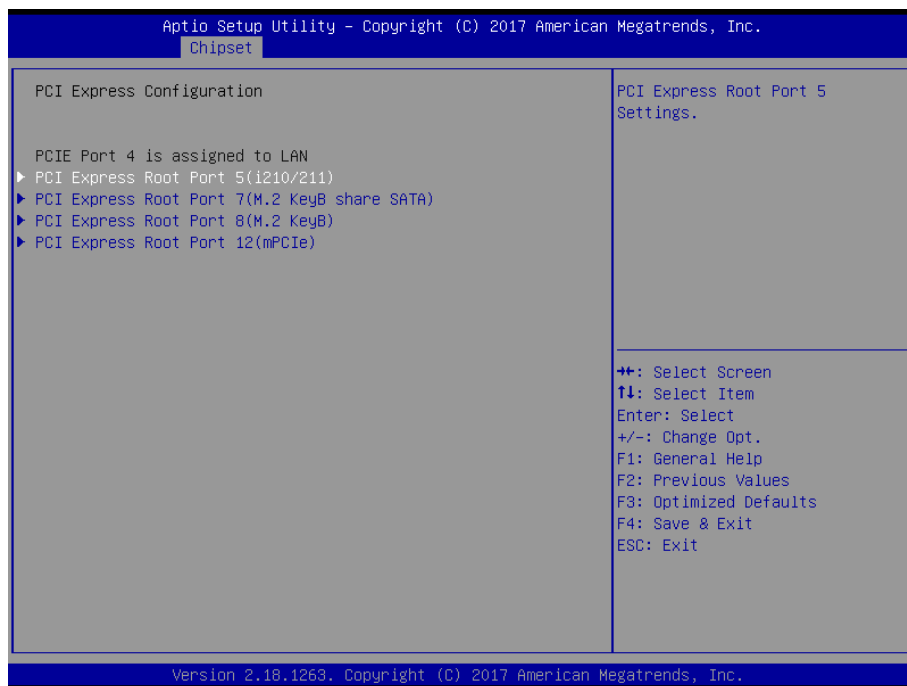

3.6.3.2.1.1 PCI Express Root Port5 (i210/211)

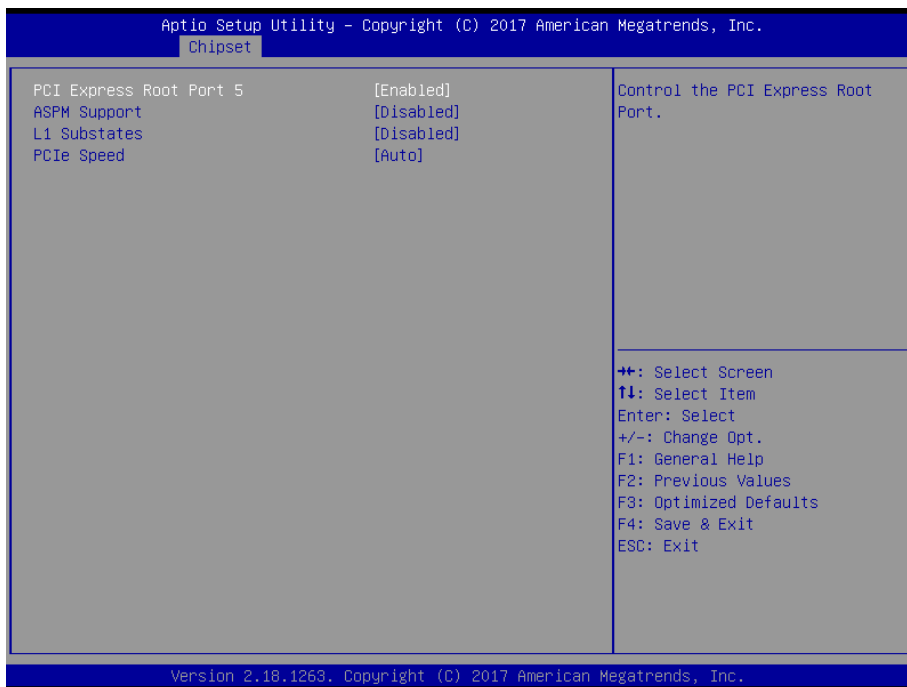

Item	Option	Description
PCI Express Root Port 5	Enabled [Default] , Disabled	Control the PCI Express Root Port.
ASPM Support	Disabled [Default] , L0s L1 L0sL1 Auto	Set the ASPM Level: Force L0s – Force all links to L0s State AUTO – BIOS auto configure DISABLE – Disables ASPM.
L1 Substates	Disabled [Default] L1.1 L1.2 L1.1 & L1.2,	PCI Express L1 Substates settings.
PCIe Speed	Auto [Default] Gen1 Gen2 Gen3	Select PCI Express port speed.

3.6.3.2.1.2 PCI Express Root Port7 (M.2 KeyB share SATA)

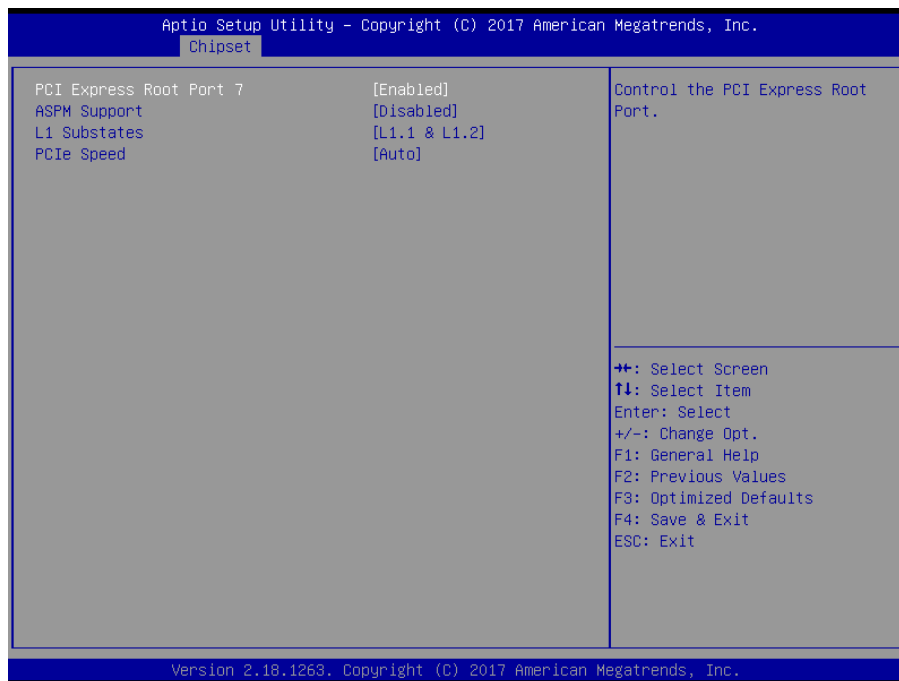

Item	Option	Description
PCI Express Root Port 7	Enabled[Default], Disabled	Control the PCI Express Root Port.
ASPM Support	Disabled[Default], L0s L1 L0sL1 Auto	Set the ASPM Level: Force L0s – Force all links to L0s State AUTO – BIOS auto configure DISABLE – Disables ASPM.
L1 Substates	Disabled L1.1 L1.2 L1.1 & L1.2[Default],	PCI Express L1 Substates settings.
PCIe Speed	Auto[Default] Gen1 Gen2 Gen3	Select PCI Express port speed.

3.6.3.2.1.3 PCI Express Root Port8 (M.2 KeyB)

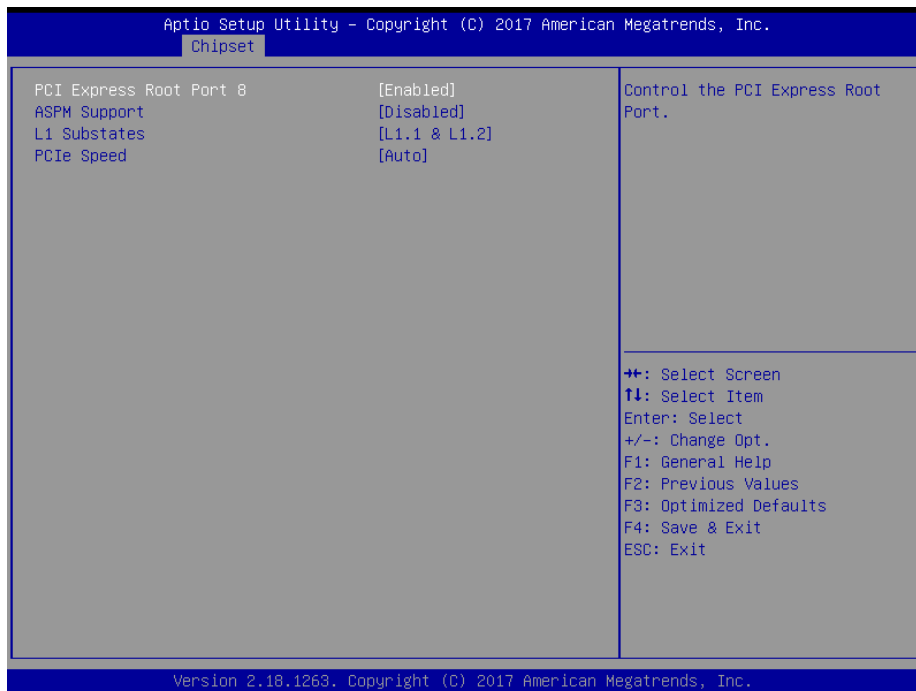

Item	Option	Description
PCI Express Root Port 8	Enabled [Default] , Disabled	Control the PCI Express Root Port.
ASPM Support	Disabled [Default] , L0s L1 L0sL1 Auto	Set the ASPM Level: Force L0s – Force all links to L0s State AUTO – BIOS auto configure DISABLE – Disables ASPM.
L1 Substates	Disabled L1.1 L1.2 L1.1 & L1.2 [Default] ,	PCI Express L1 Substates settings.
PCIe Speed	Auto [Default] Gen1 Gen2 Gen3	Select PCI Express port speed.

3.6.3.2.1.4 PCI Express Root Port12 (mPCIE)

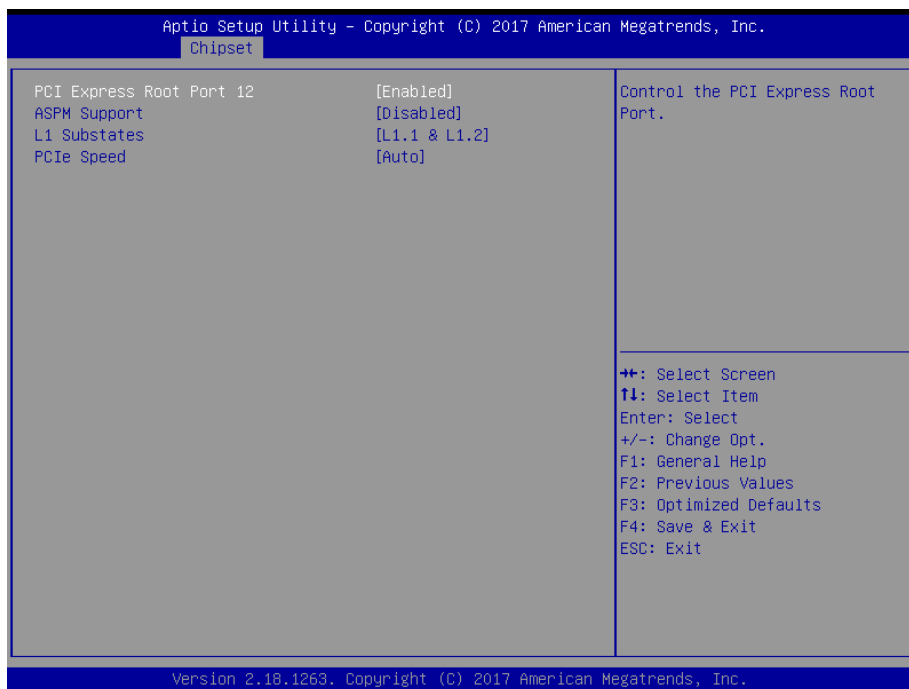

Item	Option	Description
PCI Express Root Port 12	Enabled [Default] , Disabled	Control the PCI Express Root Port.
ASPM Support	Disabled [Default] , L0s L1 L0sL1 Auto	Set the ASPM Level: Force L0s – Force all links to L0s State AUTO – BIOS auto configure DISABLE – Disables ASPM.
L1 Substates	Disabled L1.1 L1.2 L1.1 & L1.2 [Default] ,	PCI Express L1 Substates settings.
PCIe Speed	Auto [Default] Gen1 Gen2 Gen3	Select PCI Express port speed.

3.6.3.2.2 USB Configuration

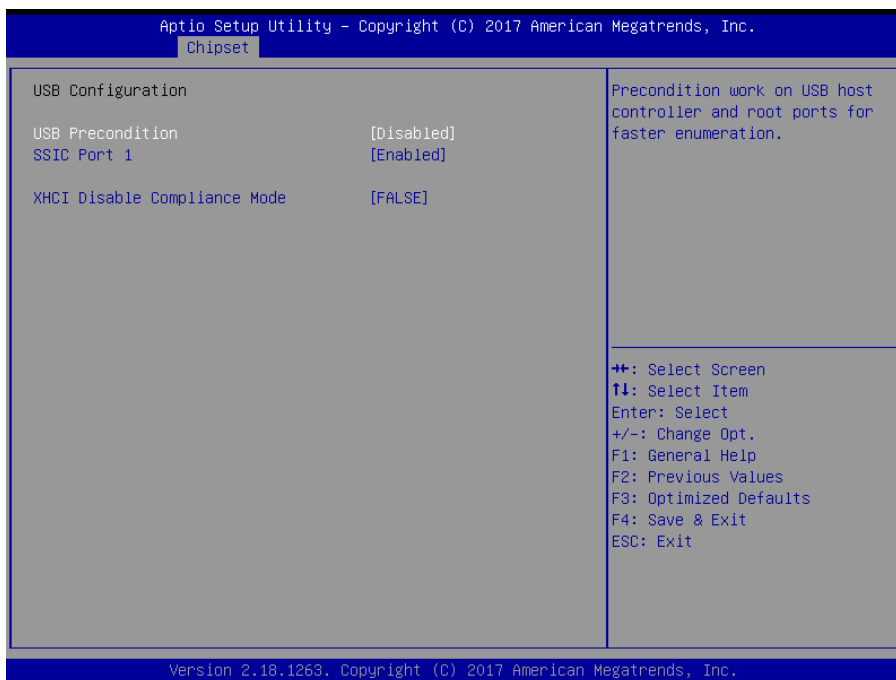

Item	Option	Description
USB Precondition	Enabled Disabled[Default],	Precondition work on USB host controller and root ports for faster enumeration.
SSIC Port 1	Enabled[Default] Disabled,	Enable/Disable support for SSIC.
XHCI Disable Compliance Mode	FALSE[Default], TRUE	Option to disable Compliance Mode. Default is FALSE to not disable Compliance Mode. Set TRUE to disable Compliance Mode.

3.6.3.2.3 HD Audio Configuration



Item	Option	Description
HD Audio	Disabled Enabled Auto[Default],	Control Detection of the HD-Audio device. Disable = HDA will be unconditionally disabled Enabled = HDA will be unconditionally enabled Auto = HDA will be enabled if present, disabled otherwise.

3.6.4 Security

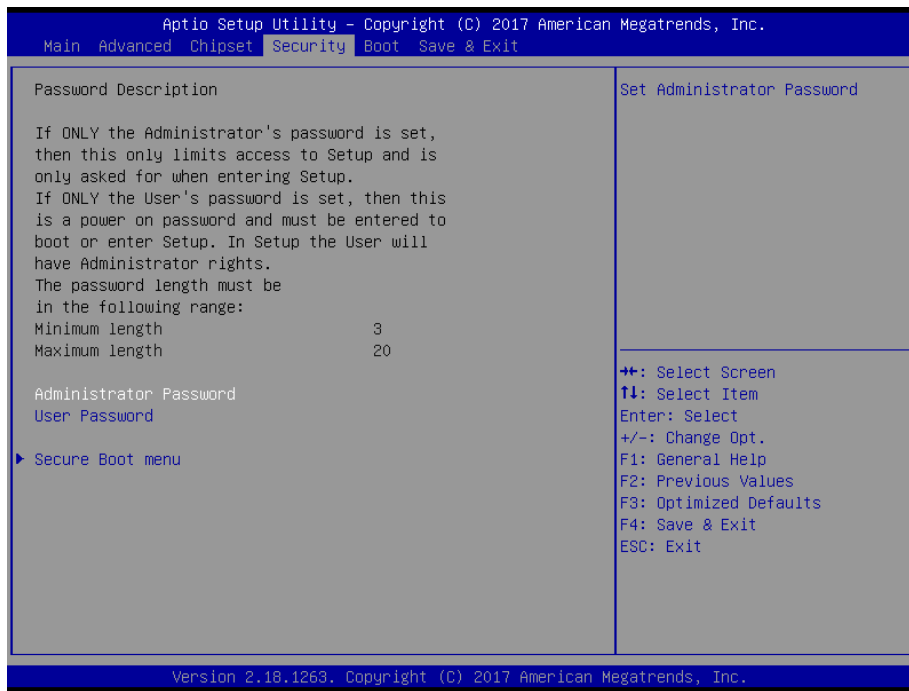

- **Administrator Password**

Set setup Administrator Password

- **User Password**

Set User Password

ECM-SKLU User's Manual

3.6.4.1 Secure Boot menu

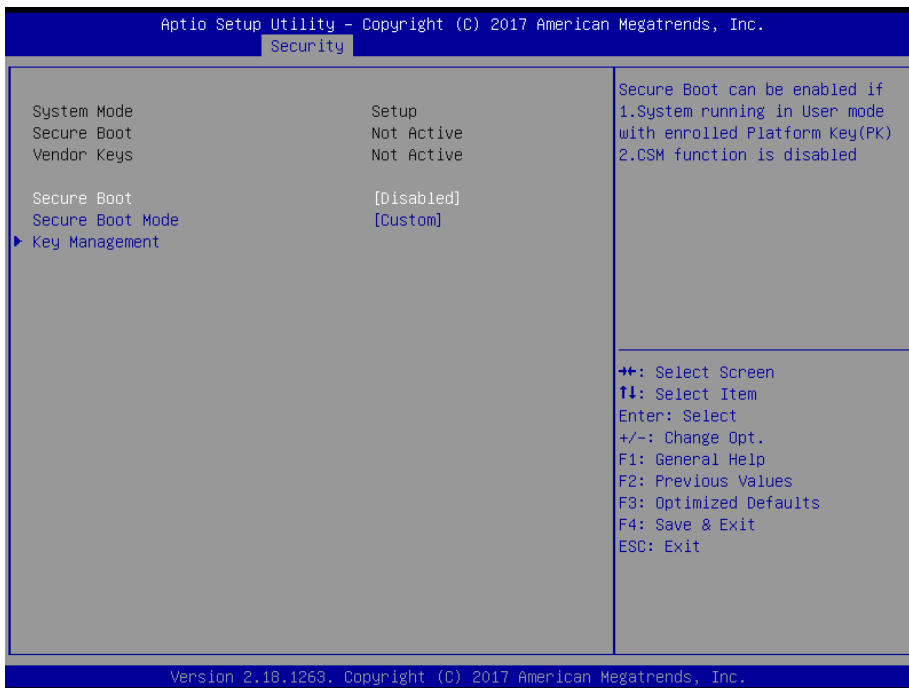

Item	Option	Description
Secure Boot	Disabled[Default] Enabled	Secure Boot can be enabled if 1.System running in User mode with enrolled Platform Key(PK) 2.CSM function is disabled.
Secure Boot Mode	Standard Custom[Default]	Secure Boot mode selector. 'Custom' Mode enables users to change Image Execution policy and manage Secure Boot Keys.

3.6.4.1.1 Key Management

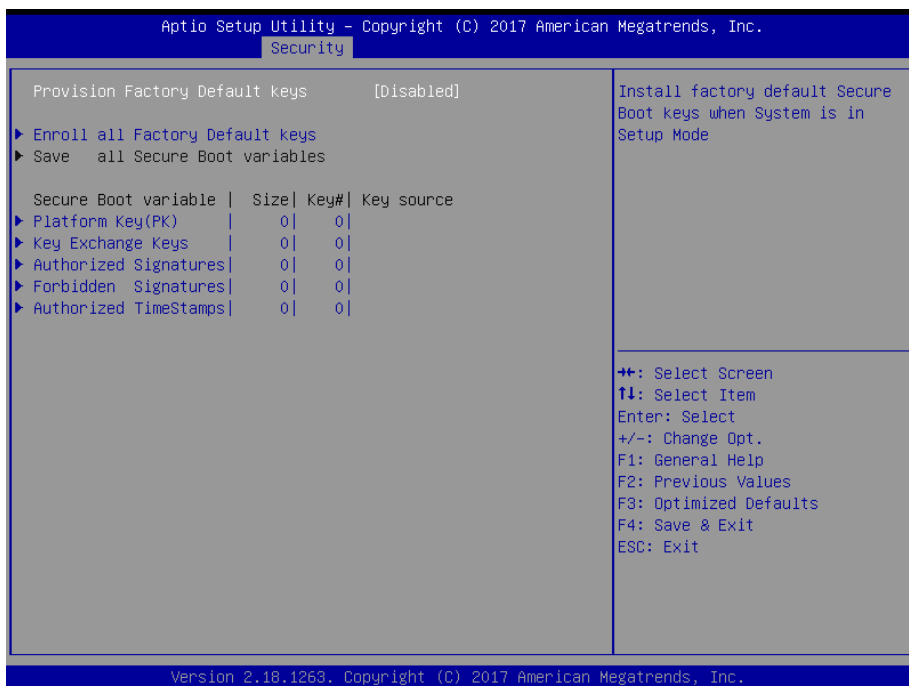

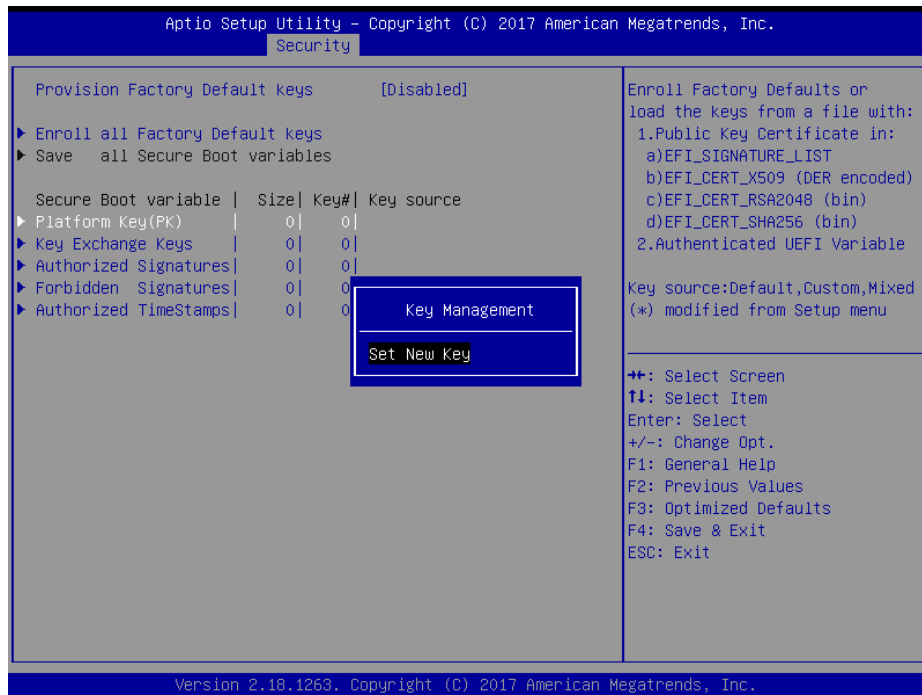
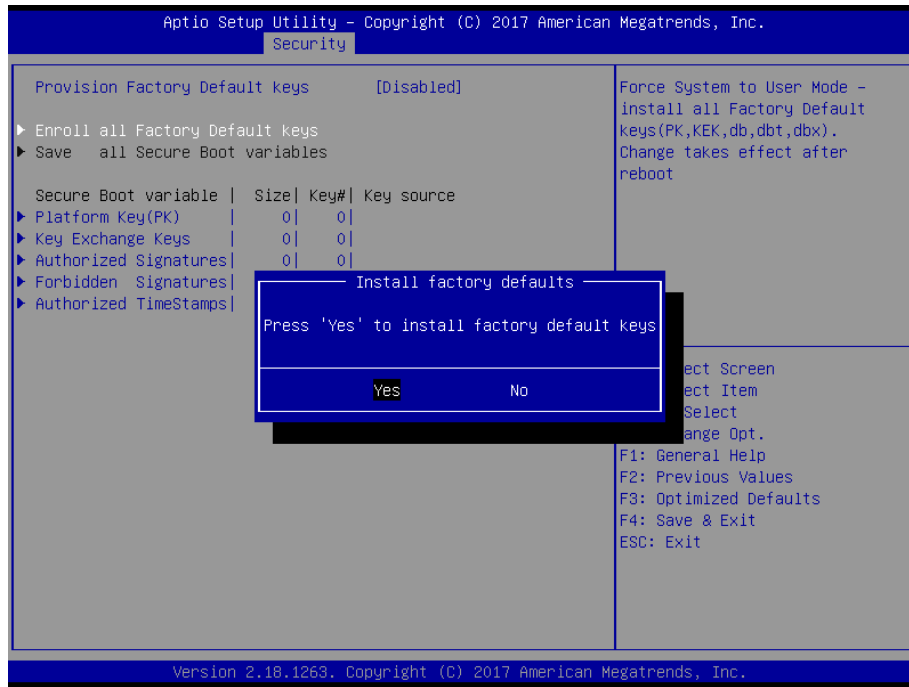

ECM-SKLU User's Manual

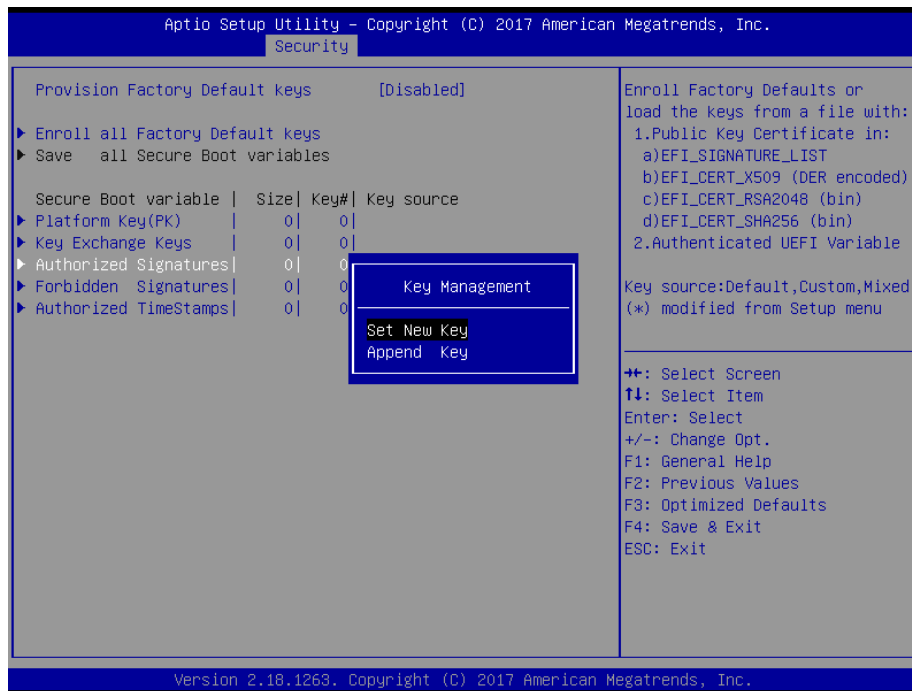
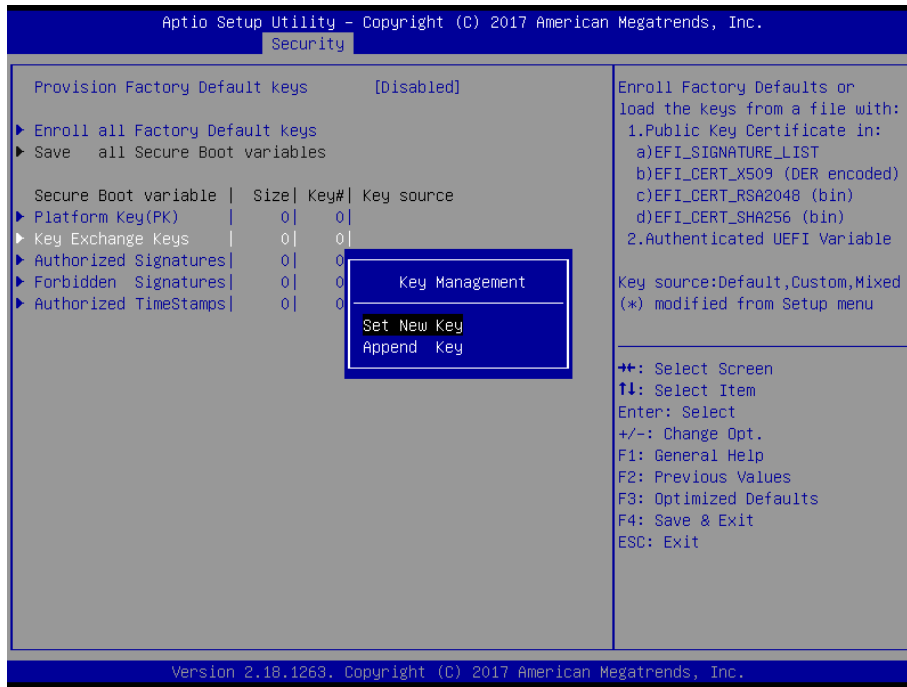

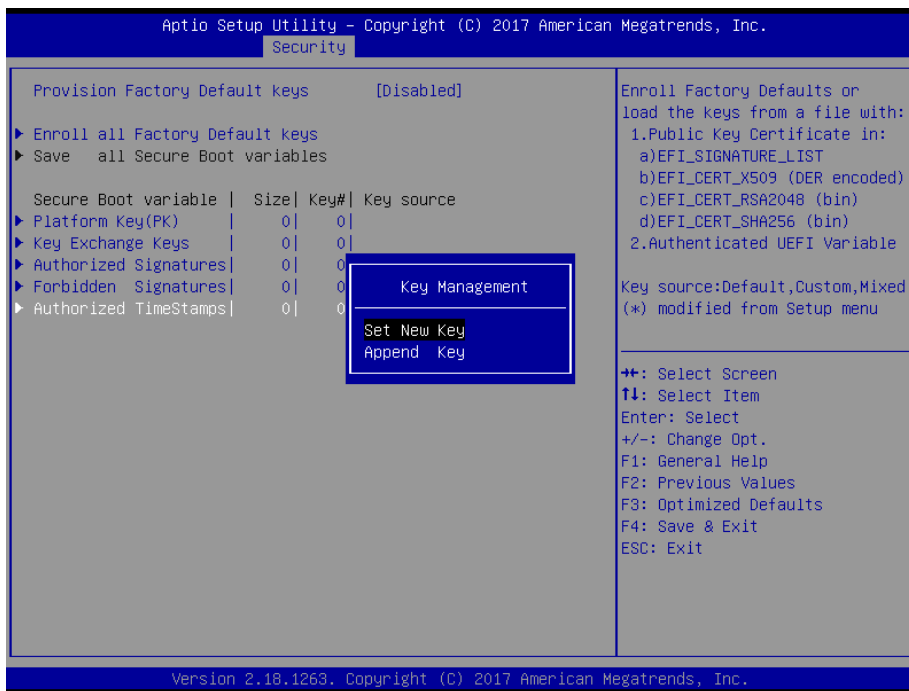
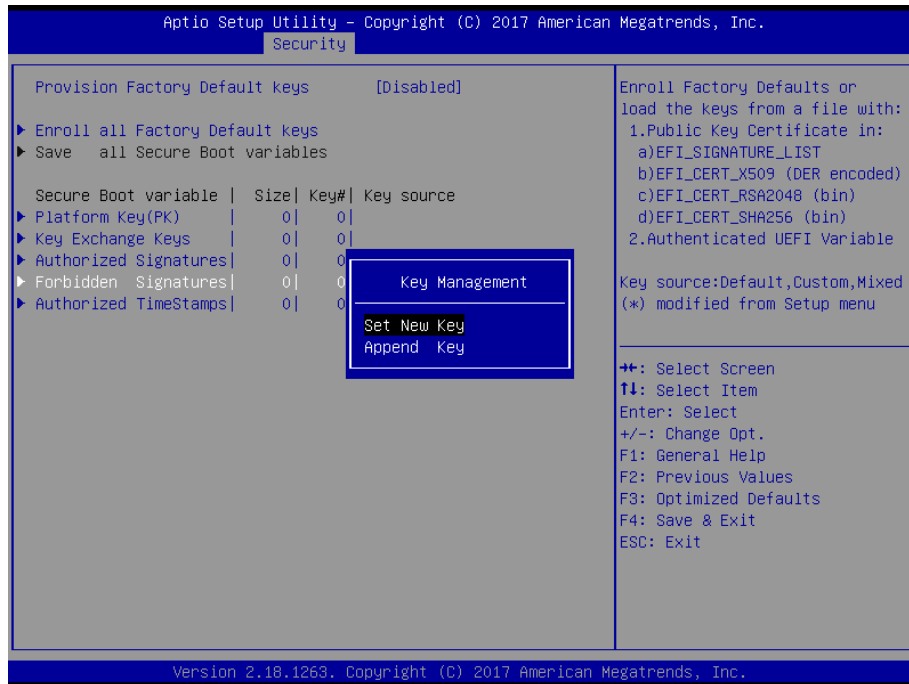

Item	Option	Description
Provision Factory Default keys	Enabled, Disabled[Default]	Install Factory default Secure Boot Keys when System is in Setup Mode.

3.6.5 Boot

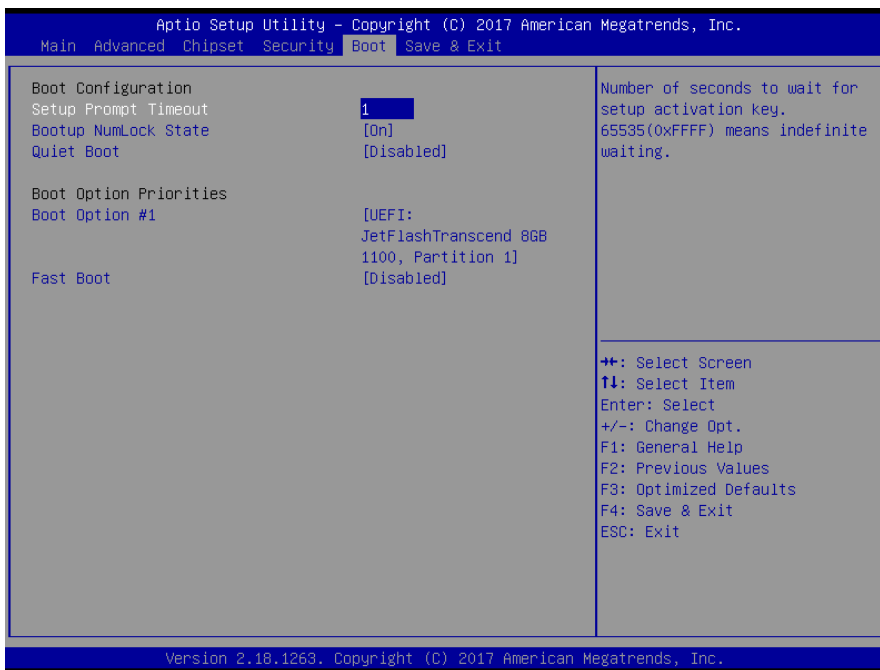

Item	Option	Description
Setup Prompt Timeout	1~ 65535	Number of seconds to wait for setup activation key. 65535(0xFFFF) means indefinite waiting.
Bootup NumLock State	On[Default] Off	Select the Keyboard NumLock state
Quiet Boot	Disabled[Default] Enabled	Enables or disables Quiet Boot option
Fast Boot	Disabled[Default] Enabled	Enables or disables boot with initialization of a minimal set of devices required to launch active boot option. Has no effect for BBS boot options.
Boot Option #1	Set the system boot order.	

3.6.6 Save and exit

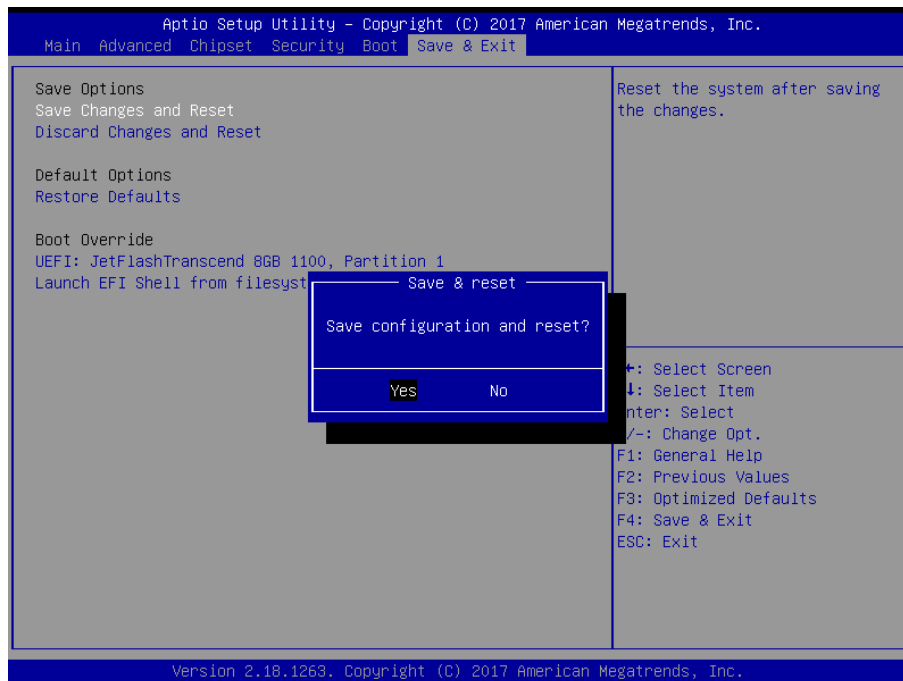
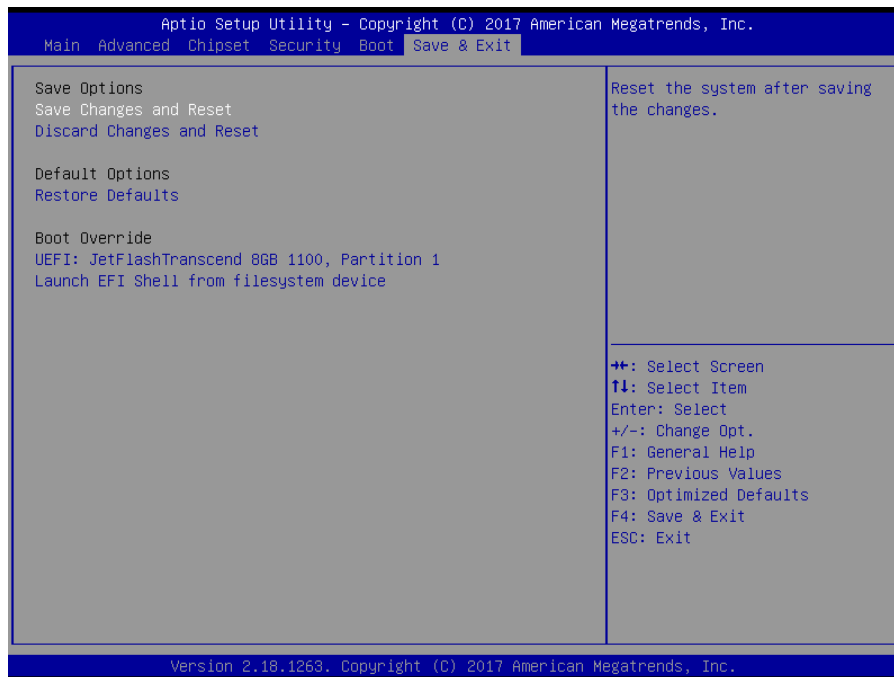

3.6.6.1 Save Changes and Reset

Reset the system after saving the changes.

ECM-SKLU User's Manual

3.6.6.2 *Discard Changes and Reset*

Any changes made to BIOS settings during this session of the BIOS setup program are discarded. The setup program then exits and reboots the controller.

3.6.6.3 *Restore Defaults*

This option restores all BIOS settings to the factory default. This option is useful if the controller exhibits unpredictable behavior due to an incorrect or inappropriate BIOS setting.

3.6.6.4 *Launch EFI Shell from filesystem device*

Attempts to Launch EFI Shell application (Shell.efi) from one of the available filesystem devices.

4. Drivers Installation



Note: Installation procedures and screen shots in this section are for your reference and may not be exactly the same as shown on your screen.

4.1 Install Chipset Driver

All drivers can be found on the Avalue Official Website:

<http://www.avalue.com.tw>.



Note: The installation procedures and screen shots in this section are based on Windows 10 operation system.

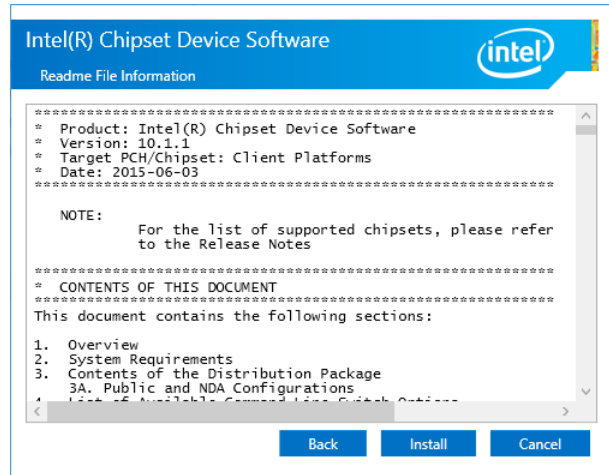

Step 3. Click Install.

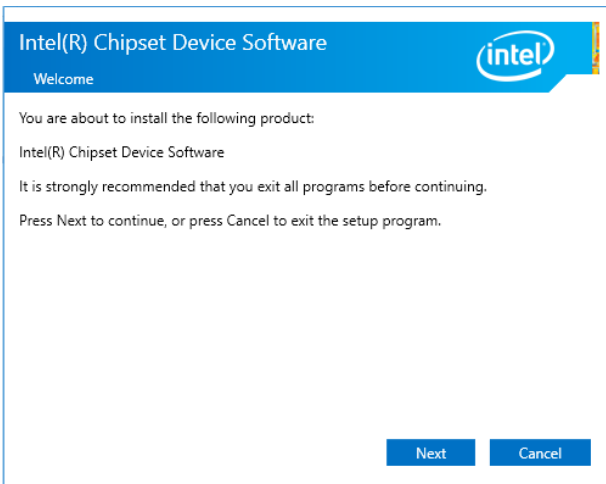

Step1. Click Next.

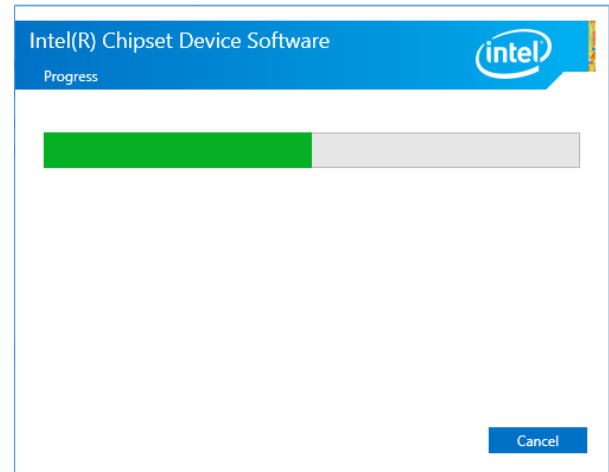

Step 4. Installing.

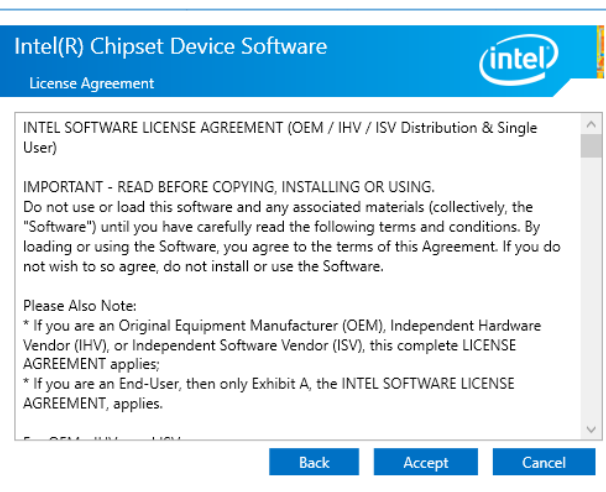

Step 2. Click Accept.

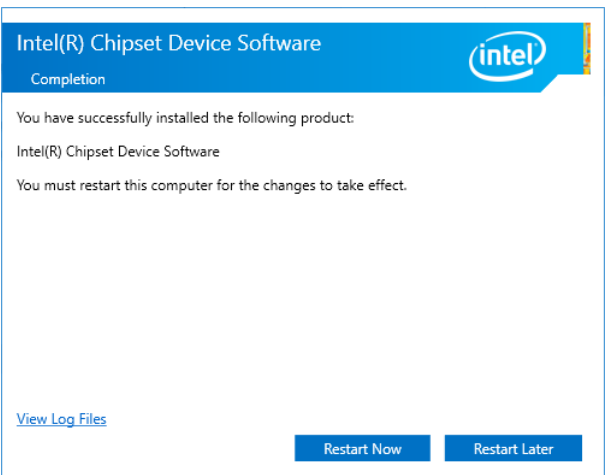

Step 5. Setup completed.

4.2 Install ME Driver

All drivers can be found on the Avalue Official Website:
<http://www.avalu.com.tw>.



Note: The installation procedures and screen shots in this section are based on Windows 10 operation system.

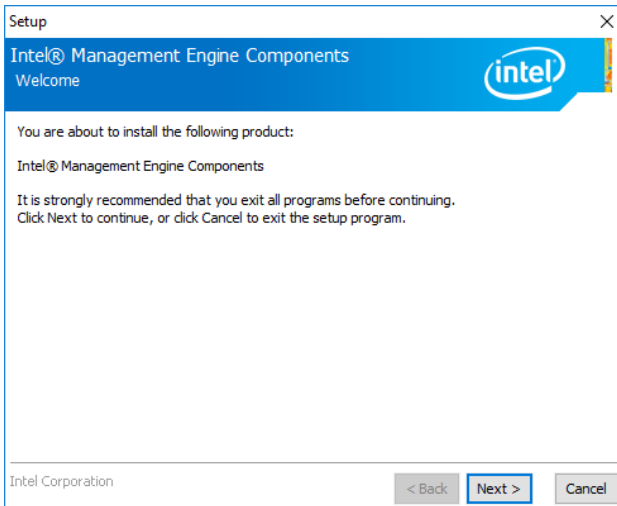

Step1. Click **Next** to start installation.

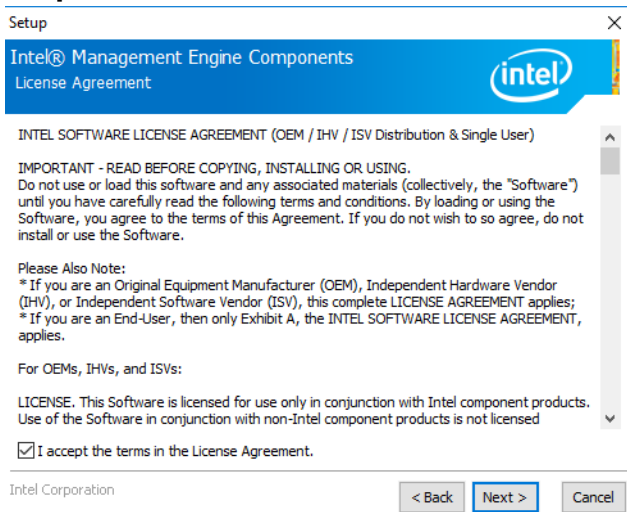

Step 2. Click **Next**.

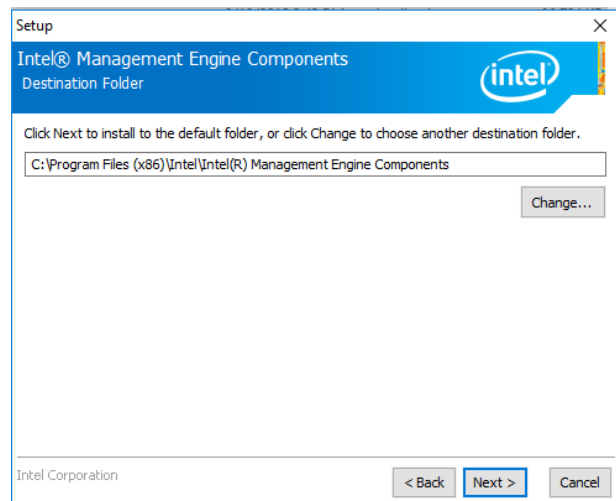

Step 3. Click **Next** to continue installation.

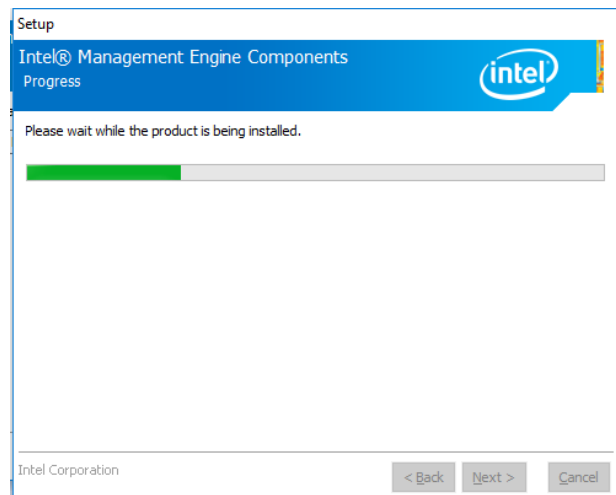

Step 4. Installing.

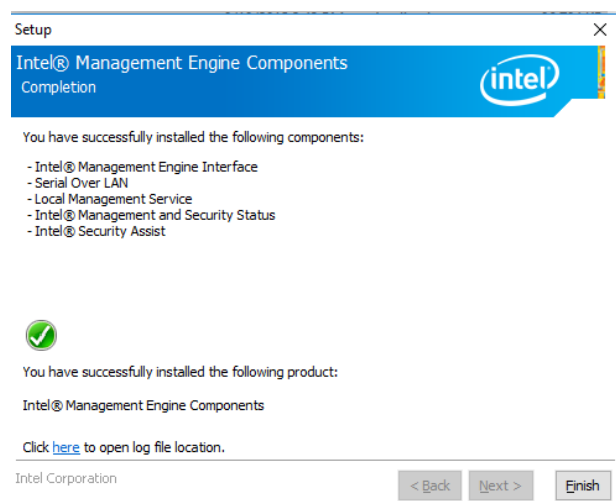

Step 5. Click **Finish** to complete setup.

4.3 Install VGA Driver

All drivers can be found on the Avalue Official Website:

<http://www.avalue.com.tw>.



Note: The installation procedures and screen shots in this section are based on Windows 10 operation system.

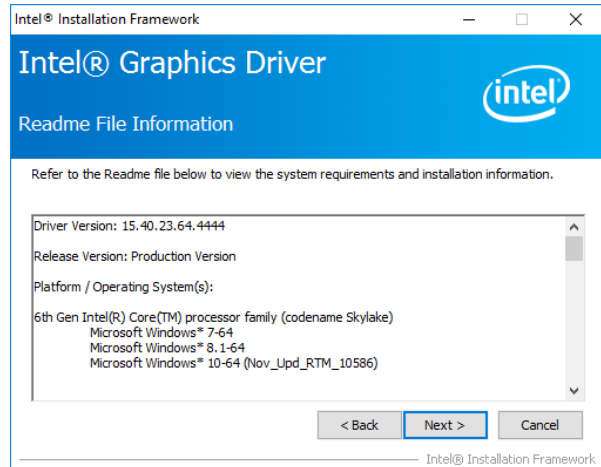

Step 3. Click Next.

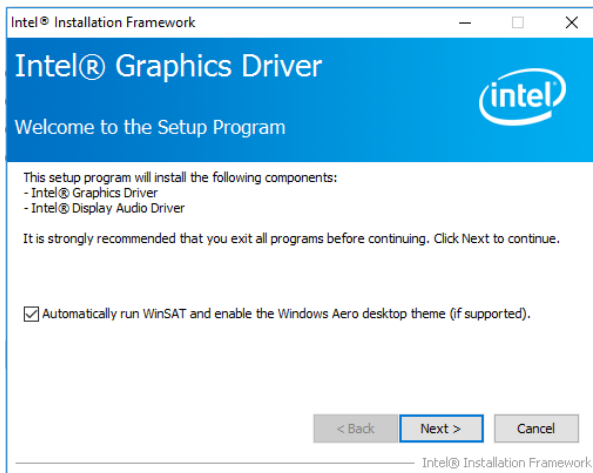

Step 1. Click Next to continue installation.

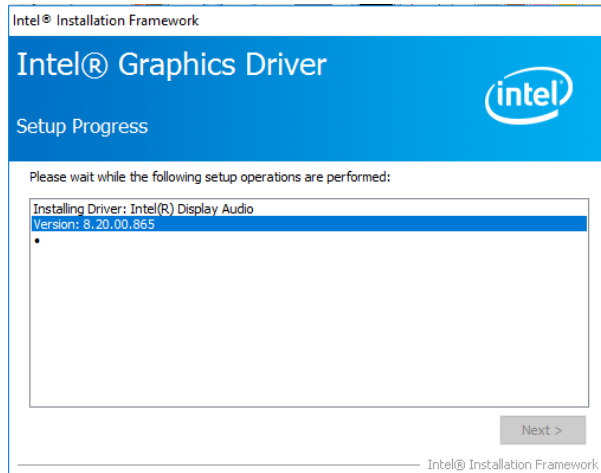

Step 4. Click Next.

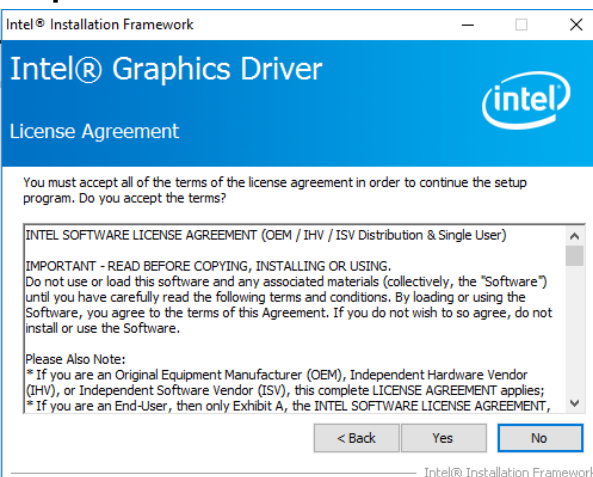

Step 2.

Click **Yes** to accept license agreement.

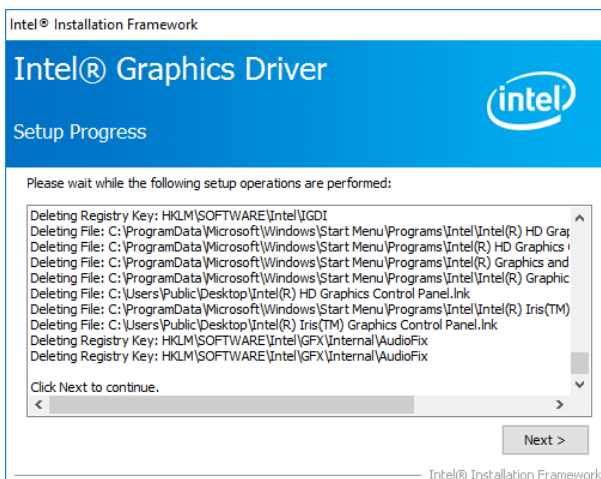

Step 5. Click Next.

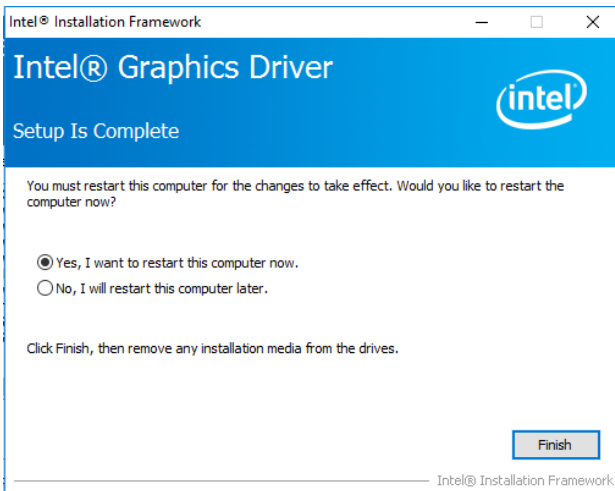

Step 6. Click **Finish** to complete setup.

4.4 Install Audio Driver (For Realtek ALC892)

All drivers can be found on the Avalue Official Website:

<http://www.avalue.com.tw>.



Note: The installation procedures and screen shots in this section are based on Windows 10 operation system.

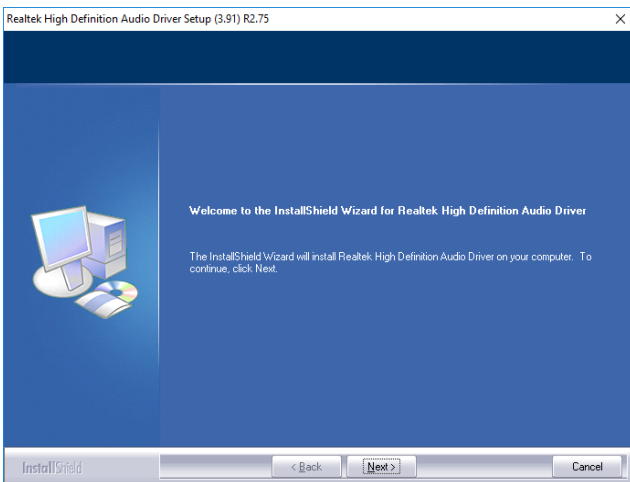

Step 1. Click **Next** to continue setup.

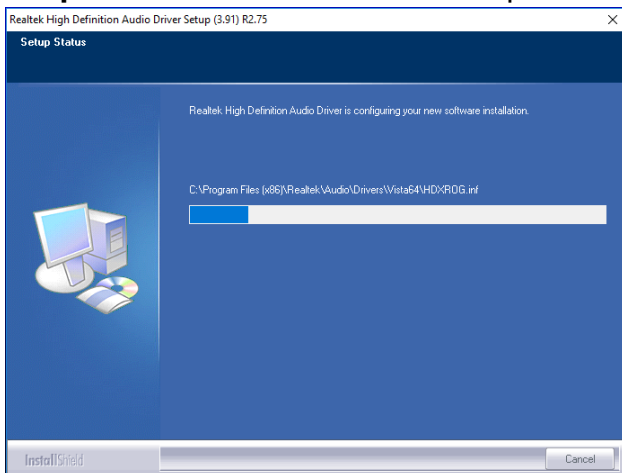

Step 2. Installing.

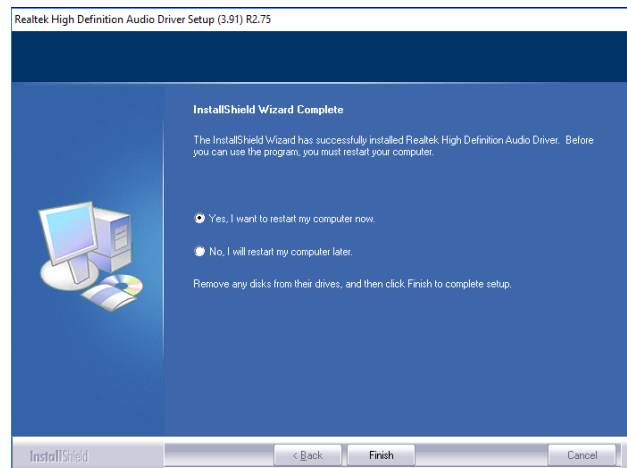

Step 3. Click **Finish** to complete the setup.

4.5 Install Ethernet Driver

All drivers can be found on the Avalue Official Website:
<http://www.avalue.com.tw>.



Note: The installation procedures and screen shots in this section are based on Windows 10 operation system.

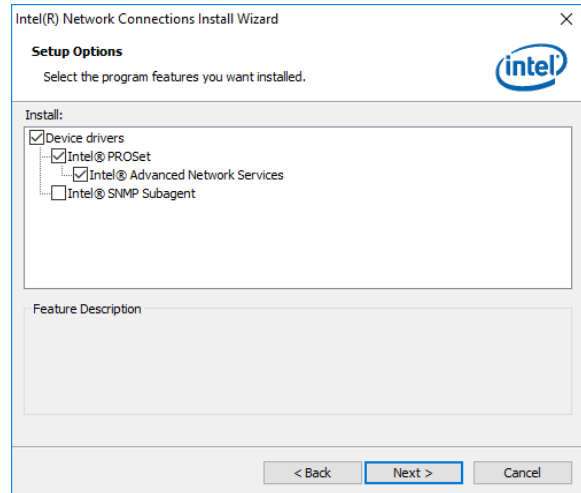

Step 3. Click Next.

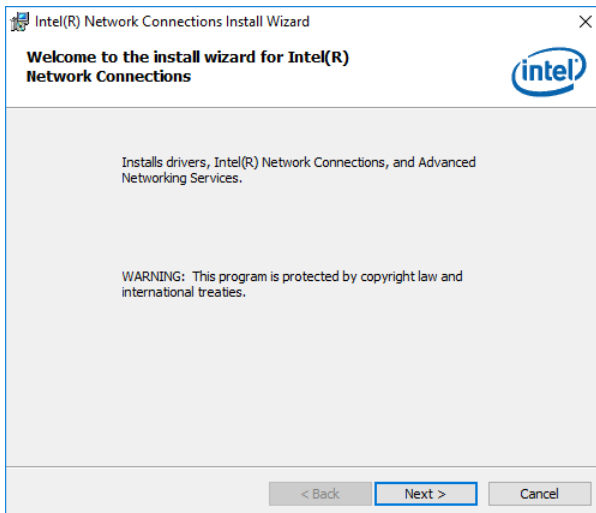

Step 1. Click Next to continue installation.

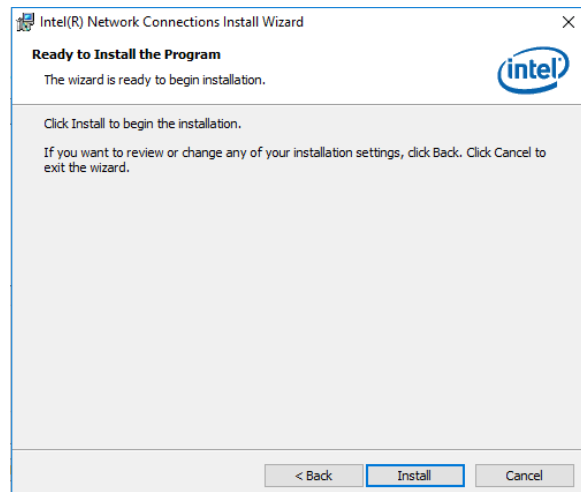

Step 4. Click Install.

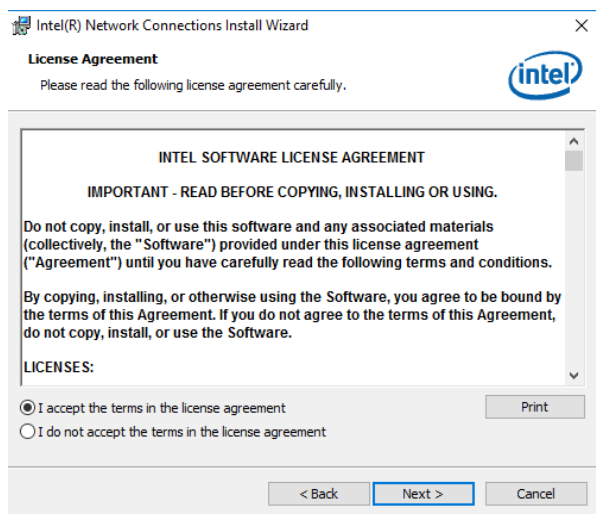

Step 2. Click Next.

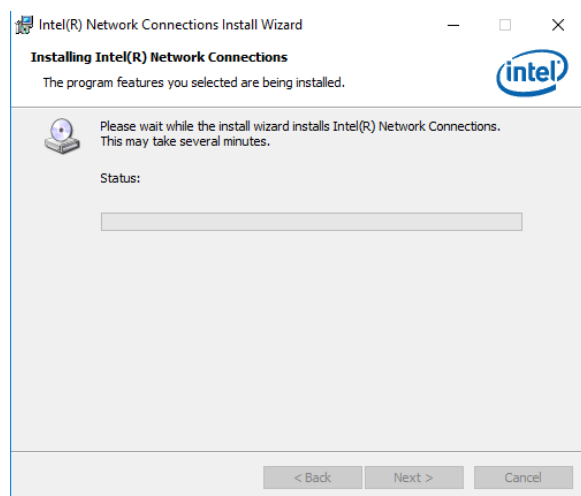

Step 5. Installing.

ECM-SKLU User's Manual

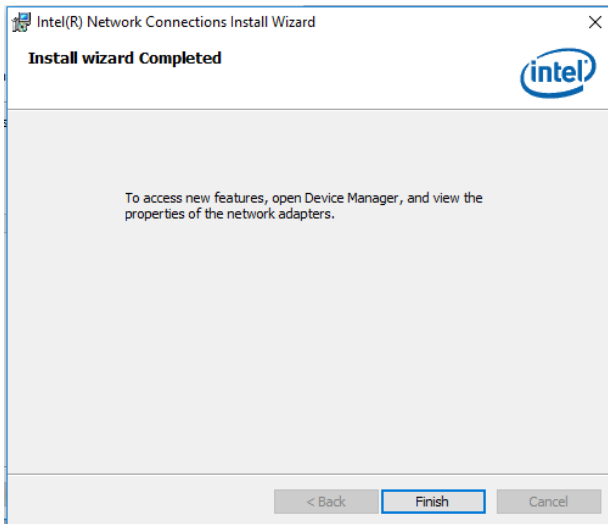

Step 6. Click **Finish** to complete setup.

4.6 Install Serial IO Driver

All drivers can be found on the Avalue Official Website:

<http://www.avalue.com.tw>.



Note: The installation procedures and screen shots in this section are based on Windows 10 operation system.

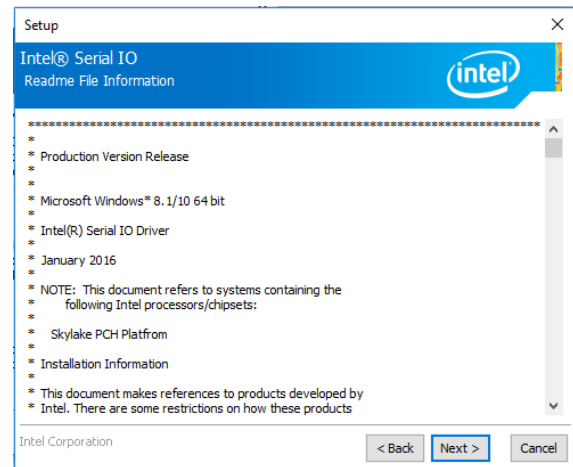

Step 3. Click Next.

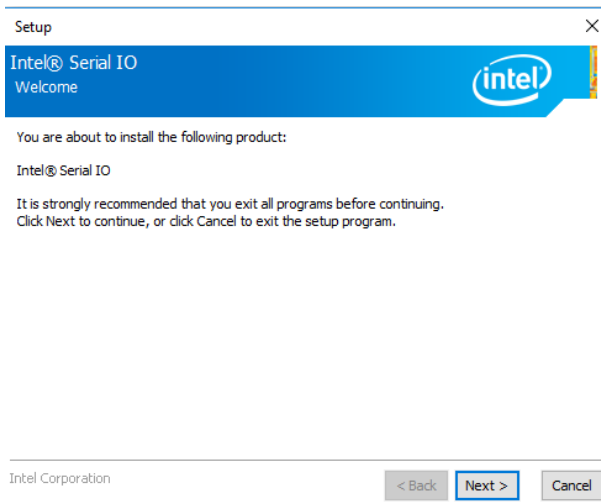

Step 1. Click Next to continue installation.

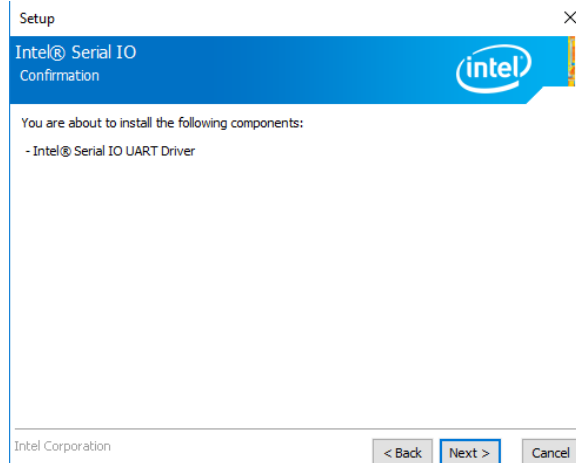

Step 4. Click Next.

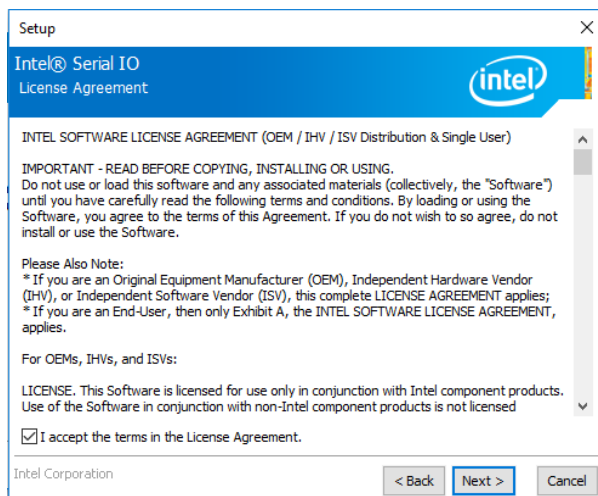

Step 2. Click Next.

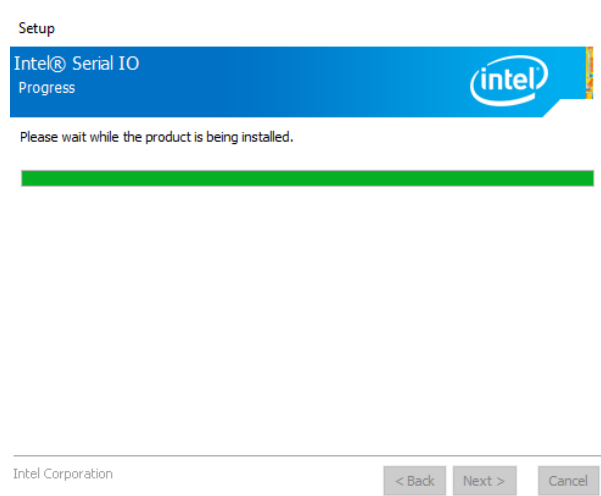

Step 5. Installing.

ECM-SKLU User's Manual

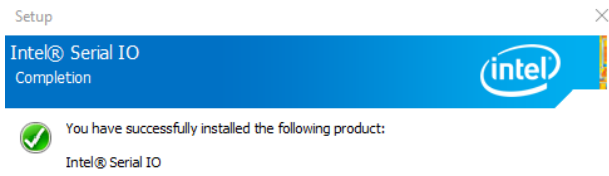

Click [here](#) to open log file location.

Intel Corporation

< Back

Next >

Finish

Step 6. Click **Finish** to complete setup.

4.7 Install IRST Driver

All drivers can be found on the Avalue Official Website:
<http://www.avalue.com.tw>.



Note: The installation procedures and screen shots in this section are based on Windows 10 operation system.

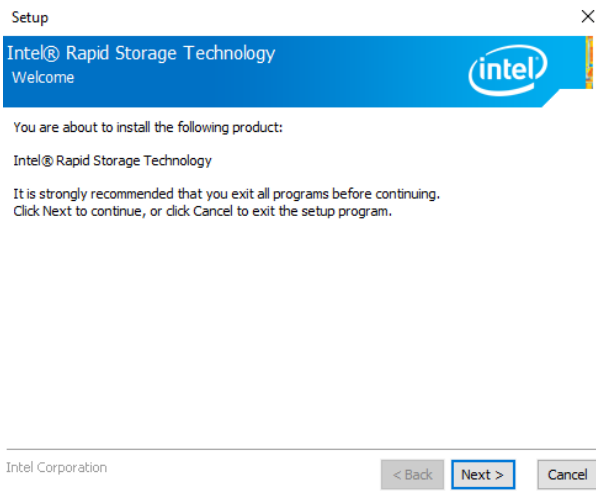

Step 1. Click Next to continue installation.

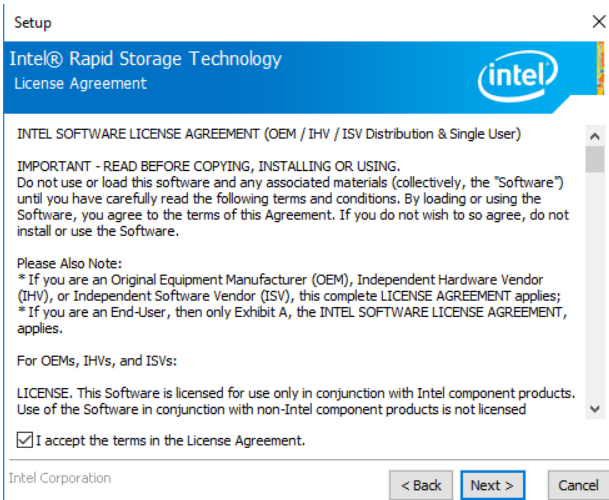

Step 2. Click Next.

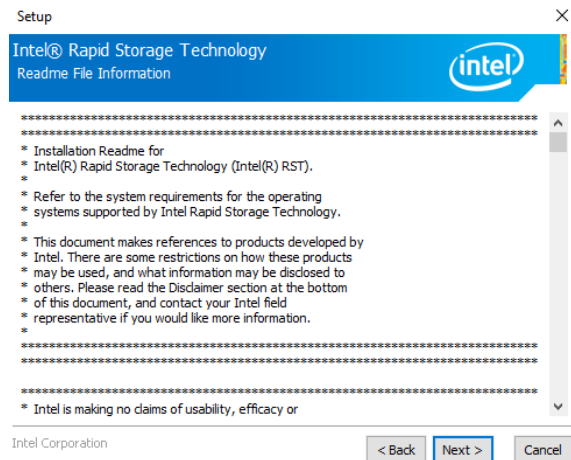

Step 3. Click Next.

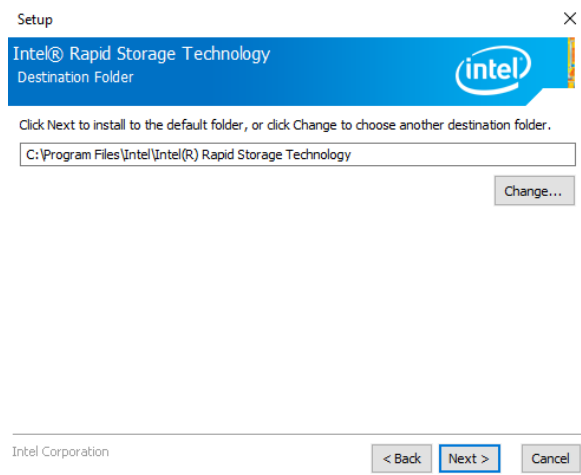

Step 4. Click Next.

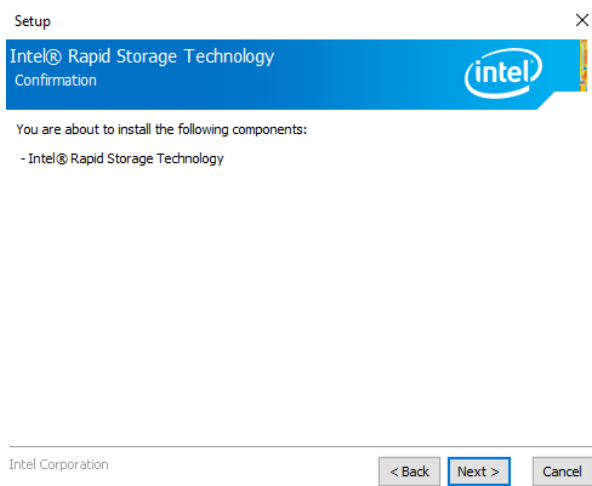

Step 5. Click Next.

ECM-SKLU User's Manual

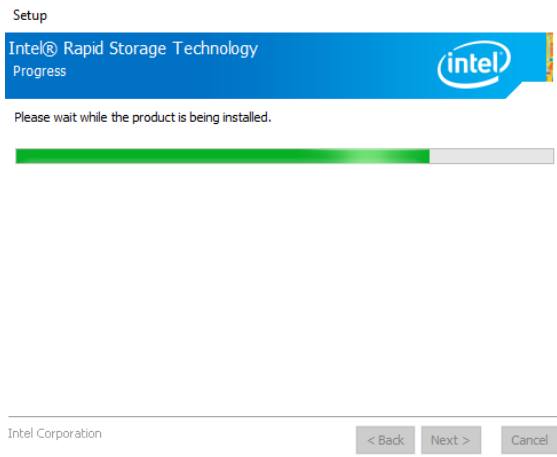

Step 6. Click Next.



Step 7. Click Finish to complete setup.

5. Mechanical Drawing

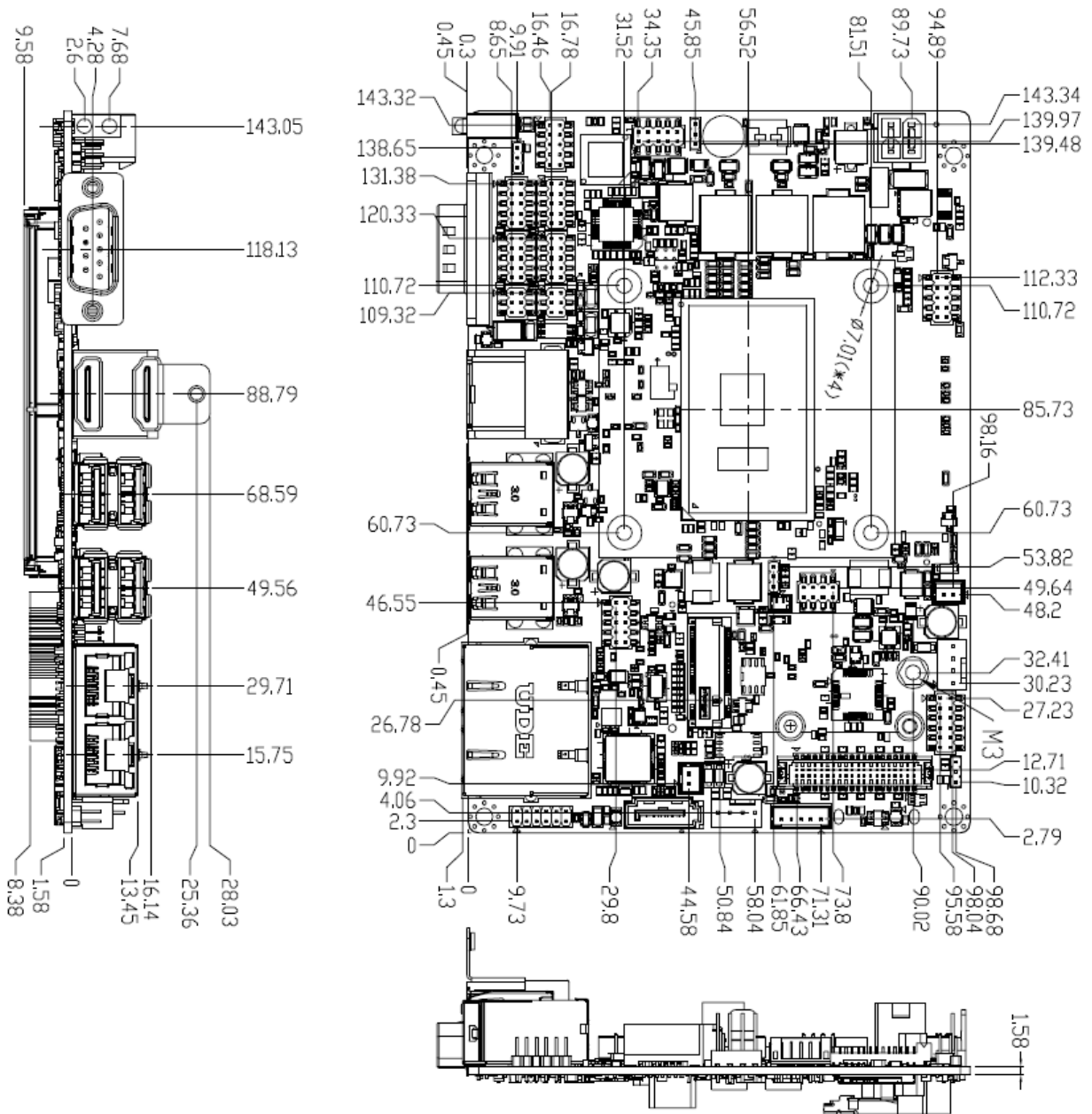

Unit: mm

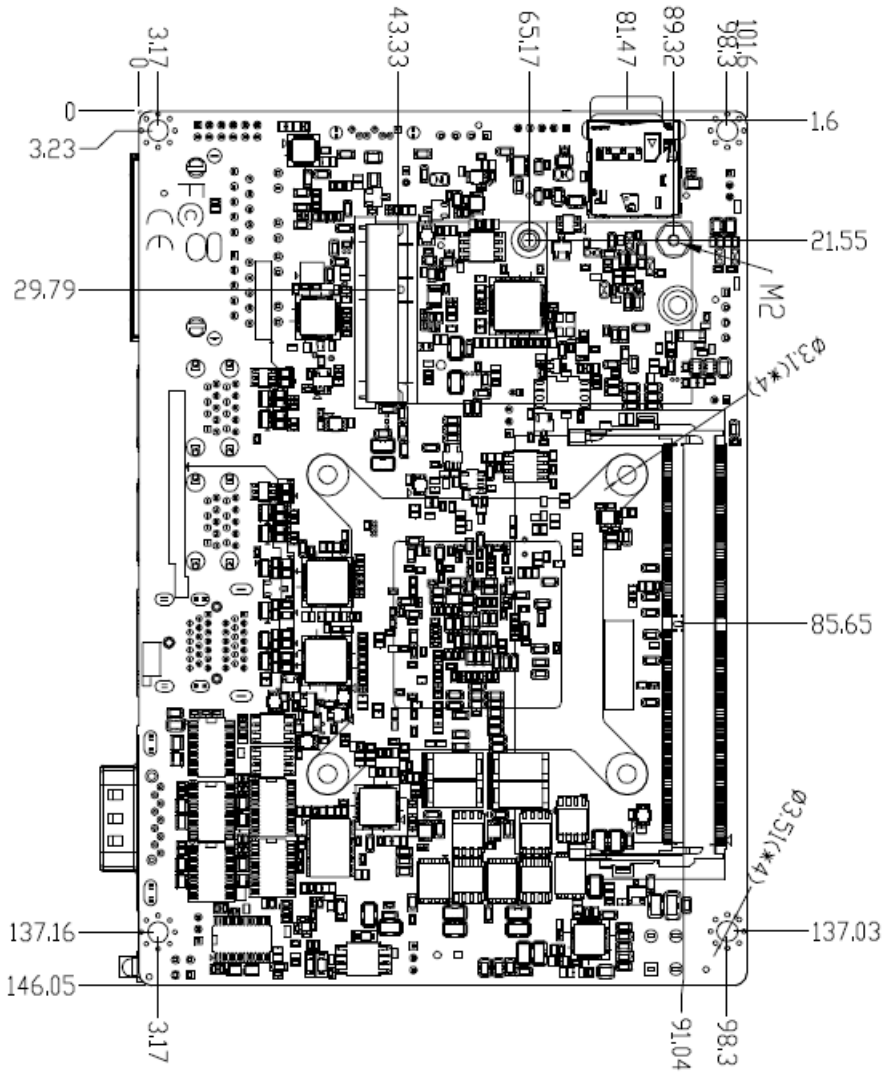

Unit: mm

