

Intel® Desktop Board DX38BT Product Guide

Order Number: D97742-001

Revision History

| Revision | Revision History | Date |
|----------|--|----------------|
| -001 | First release of the Intel® Desktop Board DX38BT Product Guide | September 2007 |

If an FCC declaration of conformity marking is present on the board, the following statement applies:

FCC Declaration of Conformity

This device complies with Part 15 of the FCC Rules. Operation is subject to the following two conditions: (1) this device may not cause harmful interference, and (2) this device must accept any interference received, including interference that may cause undesired operation.

For questions related to the EMC performance of this product, contact:

Intel Corporation, 5200 N.E. Elam Young Parkway, Hillsboro, OR 97124
1-800-628-8686

This equipment has been tested and found to comply with the limits for a Class B digital device, pursuant to Part 15 of the FCC Rules. These limits are designed to provide reasonable protection against harmful interference in a residential installation. This equipment generates, uses, and can radiate radio frequency energy and, if not installed and used in accordance with the instructions, may cause harmful interference to radio communications. However, there is no guarantee that interference will not occur in a particular installation. If this equipment does cause harmful interference to radio or television reception, which can be determined by turning the equipment off and on, the user is encouraged to try to correct the interference by one or more of the following measures:

- Reorient or relocate the receiving antenna.
- Increase the separation between the equipment and the receiver.
- Connect the equipment to an outlet on a circuit other than the one to which the receiver is connected.
- Consult the dealer or an experienced radio/TV technician for help.

Any changes or modifications to the equipment not expressly approved by Intel Corporation could void the user's authority to operate the equipment.

Tested to comply with FCC standards for home or office use.

Canadian Department of Communications Compliance Statement

This digital apparatus does not exceed the Class B limits for radio noise emissions from digital apparatus set out in the Radio Interference Regulations of the Canadian Department of Communications.

Le présent appareil numérique n'émet pas de bruits radioélectriques dépassant les limites applicables aux appareils numériques de la classe B prescrites dans le Règlement sur le brouillage radioélectrique édicté par le ministère des Communications du Canada.

Disclaimer

INFORMATION IN THIS DOCUMENT IS PROVIDED IN CONNECTION WITH INTEL® PRODUCTS. NO LICENSE, EXPRESS OR IMPLIED, BY ESTOPPEL OR OTHERWISE, TO ANY INTELLECTUAL PROPERTY RIGHTS IS GRANTED BY THIS DOCUMENT. EXCEPT AS PROVIDED IN INTEL'S TERMS AND CONDITIONS OF SALE FOR SUCH PRODUCTS, INTEL ASSUMES NO LIABILITY WHATSOEVER, AND INTEL DISCLAIMS ANY EXPRESS OR IMPLIED WARRANTY, RELATING TO SALE AND/OR USE OF INTEL PRODUCTS INCLUDING LIABILITY OR WARRANTIES RELATING TO FITNESS FOR A PARTICULAR PURPOSE, MERCHANTABILITY, OR INFRINGEMENT OF ANY PATENT, COPYRIGHT OR OTHER INTELLECTUAL PROPERTY RIGHT. Intel products are not intended for use in medical, life saving, or life sustaining applications. Intel may make changes to specifications and product descriptions at any time, without notice.

Desktop Board DX38BT may contain design defects or errors known as errata which may cause the product to deviate from published specifications. Current characterized errata are available on request.

Contact your local Intel sales office or your distributor to obtain the latest specifications and before placing your product order.

Copies of documents which have an ordering number and are referenced in this document, or other Intel literature, may be obtained from Intel Corporation by going to the World Wide Web site at: <http://www.intel.com/> or by calling 1-800-548-4725.

Intel and Pentium are trademarks of Intel Corporation in the United States and other countries.

* Other names and brands may be claimed as the property of others.

Copyright © 2007, Intel Corporation. All rights reserved.

Preface

This Product Guide gives information about board layout, component installation, BIOS update, and regulatory requirements for Intel® Desktop Board DX38BT.

Intended Audience

The Product Guide is intended for technically qualified personnel. It is not intended for general audiences.

Use Only for Intended Applications

All Intel Desktop Boards are evaluated as Information Technology Equipment (I.T.E.) for use in personal computers (PC) for installation in homes, offices, schools, computer rooms, and similar locations. The suitability of this product for other PC or embedded non-PC applications or other environments, such as medical, industrial, alarm systems, test equipment, etc. may not be supported without further evaluation by Intel.

Document Organization

The chapters in this Product Guide are arranged as follows:

- 1 Desktop Board Features: a summary of product features
- 2 Installing and Replacing Desktop Board Components: instructions on how to install the Desktop Board and other hardware components
- 3 Updating the BIOS: instructions on how to update the BIOS
- 4 Configuring for RAID (Intel® Matrix Storage Technology): information about configuring your system for RAID
- A Error Messages and Indicators: information about BIOS error messages and beep codes
- B Regulatory Compliance: describes the board's adherence to safety standards and EMC regulations and its product certifications

Conventions

The following conventions are used in this manual:



CAUTION

Cautions warn the user about how to prevent damage to hardware or loss of data.



NOTE

Notes call attention to important information.

Terminology

The table below gives descriptions of some common terms used in the product guide.

| Term | Description |
|-------------|--------------------------------|
| GB | Gigabyte (1,073,741,824 bytes) |
| GHz | Gigahertz (one billion hertz) |
| KB | Kilobyte (1024 bytes) |
| MB | Megabyte (1,048,576 bytes) |
| Mb | Megabit (1,048,576 bits) |
| MHz | Megahertz (one million hertz) |

Contents

1 Desktop Board Features

| | |
|---|----|
| Supported Operating Systems..... | 11 |
| Desktop Board Components..... | 12 |
| Processor..... | 14 |
| Main Memory..... | 15 |
| Intel® X38 Express Chipset..... | 15 |
| Audio Subsystem | 16 |
| LAN Subsystem | 16 |
| USB 2.0 Support..... | 17 |
| Enhanced IDE Interface | 18 |
| Serial ATA..... | 18 |
| Legacy I/O..... | 18 |
| Expandability..... | 18 |
| BIOS..... | 19 |
| Serial ATA and IDE Auto Configuration..... | 19 |
| PCI and PCI Express* Auto Configuration | 19 |
| Security Passwords..... | 19 |
| Hardware Management | 20 |
| Hardware Monitoring and Fan Speed Control | 20 |
| Intel® Precision Cooling Technology | 20 |
| Chassis Intrusion..... | 20 |
| Power Management..... | 21 |
| Software Support | 21 |
| ACPI..... | 21 |
| Hardware Support | 21 |
| Power Connectors | 21 |
| Fan Headers | 22 |
| LAN Wake Capabilities..... | 22 |
| Instantly Available PC Technology..... | 22 |
| +5 V Standby Power Indicator..... | 23 |
| Wake from USB | 24 |
| PME# Signal Wake-up Support..... | 24 |
| WAKE# Signal Wake-up Support | 24 |
| ENERGY STAR* Capable | 24 |
| Onboard Power Button..... | 25 |
| Onboard VR and CPU LEDs | 26 |
| Speaker..... | 26 |
| Battery | 27 |
| Real-Time Clock..... | 27 |

2 Installing and Replacing Desktop Board Components

| | |
|---|----|
| Before You Begin | 29 |
| Installation Precautions..... | 30 |
| Prevent Power Supply Overload | 30 |
| Observe Safety and Regulatory Requirements..... | 30 |
| Installing the I/O Shield | 31 |
| Installing and Removing the Desktop Board | 32 |

| | |
|--|----|
| Installing and Removing a Processor | 33 |
| Installing a Processor | 33 |
| Installing the Processor Fan Heat Sink | 37 |
| Connecting the Processor Fan Heat Sink Cable | 37 |
| Removing the Processor | 38 |
| Installing the ICH Heat Sink Decorative Cover (Optional) | 38 |
| Installing an MCH Heat Sink Fan (Optional)..... | 39 |
| Installing and Removing Memory..... | 40 |
| Guidelines for Dual Channel Memory Configuration..... | 40 |
| Two or Four DIMMs | 40 |
| Three DIMMs | 41 |
| Installing DIMMs | 42 |
| Removing DIMMs..... | 44 |
| Installing and Removing a PCI Express x16 Card | 45 |
| Installing Multiple PCI Express x16 Graphics Cards | 45 |
| Installing a PCI Express x16 Card | 46 |
| Removing a PCI Express x16 Card | 47 |
| Connecting the IDE Cable..... | 48 |
| Connecting the Serial ATA (SATA) Cables | 49 |
| Connecting to the Internal Headers | 50 |
| Front Panel Audio Header | 51 |
| HD Audio Link Header | 51 |
| Consumer IR (CIR) Headers | 51 |
| Chassis Intrusion Header | 52 |
| IEEE 1394a Header | 53 |
| USB 2.0 Headers | 53 |
| Front Panel Header | 54 |
| Alternate Front Panel Power LED Header | 54 |
| Connecting to the Flexible Audio System | 55 |
| Connecting Chassis Fan and Power Supply Cables..... | 56 |
| Connecting Chassis Fan Cables | 56 |
| Connecting Power Supply Cables | 57 |
| Setting the BIOS Configuration Jumper | 58 |
| Clearing Passwords | 59 |
| Replacing the Battery | 60 |

3 Updating the BIOS

| | |
|---|----|
| Updating the BIOS with the Intel® Express BIOS Update Utility..... | 65 |
| Updating the BIOS with the ISO Image BIOS Update File or the Iflash Memory Update Utility..... | 66 |
| Obtaining the BIOS Update File | 66 |
| Updating the BIOS with the ISO Image BIOS Update File | 66 |
| Updating the BIOS with the Iflash Memory Update Utility | 67 |
| Recovering the BIOS..... | 68 |

4 Configuring for RAID (Intel® Matrix Storage Technology)

| | |
|---|----|
| Configuring the BIOS for Intel Matrix Storage Technology | 69 |
| Creating Your RAID Set | 69 |
| Loading the Intel Matrix Storage Technology RAID Drivers and Software | 70 |
| Setting Up a "RAID Ready" System | 70 |

A Error Messages and Indicators

| | |
|---------------------------|----|
| BIOS Beep Codes | 71 |
| BIOS Error Messages | 71 |

B Regulatory Compliance

| | |
|--|----|
| Safety Standards | 73 |
| Place Battery Marking | 73 |
| European Union Declaration of Conformity Statement..... | 74 |
| Product Ecology Statements | 75 |
| Recycling Considerations | 75 |
| Lead-free 2LI/Pb-free 2LI Board | 78 |
| Restriction of Hazardous Substances (RoHS) | 79 |
| EU RoHS | 79 |
| China RoHS | 80 |
| EMC Regulations | 82 |
| Ensure Electromagnetic Compatibility (EMC) Compliance..... | 83 |
| Product Certifications..... | 84 |
| Board-Level Certification Markings | 84 |
| Chassis and Component Certifications..... | 85 |

Figures

| | |
|--|----|
| 1. Desktop Board DX38BT Components | 12 |
| 2. LAN Connector LEDs | 17 |
| 3. Location of the Standby Power Indicator | 23 |
| 4. Onboard Power Button | 25 |
| 5. Location of the VR and CPU LEDs | 26 |
| 6. Installing the I/O Shield | 31 |
| 7. Desktop Board DX38BT Mounting Screw Hole Locations | 32 |
| 8. Lift the Socket Lever | 33 |
| 9. Lift the Load Plate..... | 34 |
| 10. Remove the Protective Socket Cover | 34 |
| 11. Remove the Processor from the Protective Processor Cover | 35 |
| 12. Install the Processor | 35 |
| 13. Close the Load Plate | 36 |
| 14. Connecting the Processor Fan Heat Sink Cable to the Processor Fan Header | 37 |
| 15. Installing the ICH Heat Sink Decorative Cover | 38 |
| 16. Installation of a Typical MCH Heat Sink Fan | 39 |
| 17. Dual Channel Memory Configuration with Two DIMMs | 40 |
| 18. Dual Channel Memory Configuration with Four DIMMs..... | 41 |
| 19. Dual Channel Memory Configuration with Three DIMMs | 41 |
| 20. Use DDR3 DIMMs | 42 |
| 21. Installing a DIMM | 43 |
| 22. Installing PCI Express x16 Graphics Cards..... | 45 |
| 23. Installing a PCI Express x16 Card | 46 |
| 24. Removing a PCI Express x16 Card | 47 |
| 25. Connecting the IDE Cable | 48 |
| 26. Connecting a Serial ATA Cable..... | 49 |
| 27. Internal Headers | 50 |
| 28. Back Panel Audio Connectors | 55 |

Intel Desktop Board DX38BT Product Guide

| | |
|---|----|
| 29. Location of the Chassis Fan Headers..... | 56 |
| 30. Connecting Power Supply Cables | 57 |
| 31. Location of the BIOS Configuration Jumper Block | 58 |
| 32. Removing the Battery | 64 |
| 33. Desktop Board DX38BT China RoHS Material Self Declaration Table | 81 |

Tables

| | |
|---|----|
| 1. Feature Summary..... | 9 |
| 2. Desktop Board DX38BT Components | 13 |
| 3. LAN Connector LEDs | 17 |
| 4. Front Panel Audio Header Signal Names..... | 51 |
| 5. HD Audio Link Header Signal Names | 51 |
| 6. Front Panel CIR Receiver (Input) Header Signal Names | 52 |
| 7. Back Panel CIR Header Emitter (Output) Header Signal Names | 52 |
| 8. Chassis Intrusion Header Signal Names | 52 |
| 9. IEEE 1394a Header Signal Names | 53 |
| 10. USB 2.0 Header Signal Names..... | 53 |
| 11. Front Panel Header Signal Names | 54 |
| 12. Alternate Front Panel Power LED Header Signal Names | 54 |
| 13. Jumper Settings for the BIOS Setup Program Modes..... | 59 |
| 14. Beep Codes | 71 |
| 15. BIOS Error Messages | 71 |
| 16. Safety Standards..... | 73 |
| 17. Lead-Free Second Level Interconnect Marks | 79 |
| 18. China RoHS Environmentally Friendly Use Period Mark..... | 80 |
| 19. EMC Regulations..... | 82 |
| 20. Product Certification Markings | 84 |

1 Desktop Board Features

This chapter briefly describes the features of Intel® Desktop Board DX38BT. Table 1 summarizes the major features of the Desktop Board.

Table 1. Feature Summary

| | |
|-------------------------------|--|
| Form Factor | ATX (304.80 millimeters [12.00 inches] x 243.84 millimeters [9.60 inches]) |
| Processor | Support for an Intel® processor in the LGA775 package |
| Main Memory | <ul style="list-style-type: none"> • Four 240-pin, DDR3 1.5 V SDRAM Dual Inline Memory Module (DIMM) sockets • 1333/1066/800 MHz single or dual channel DDR3 SDRAM interface • Support for up to 8 GB of system memory |
| Chipset | Intel® X38 Express Chipset consisting of: <ul style="list-style-type: none"> • Intel X38 Express Chipset Memory Controller Hub (MCH) with Direct Media Interface interconnect • Intel® 82801IR I/O Controller Hub (ICH9R) supporting Intel® Matrix Storage Technology |
| Graphics | Support for Multiple PCI Express* graphics cards |
| Audio | <ul style="list-style-type: none"> • Independent multi-streaming 8-channel (7.1) audio and 2-channel audio subsystem, featuring: <ul style="list-style-type: none"> — Intel® High Definition Audio interface — IDT* STAC9274D audio codec • HD Audio Link header |
| Expansion Capabilities | <ul style="list-style-type: none"> • Two PCI Express 2.0 x16 ports • One PCI Express 1.1 x4 port (routed to a x16 connector) • Two PCI* bus connectors |
| Legacy I/O Support | Legacy I/O Controller that provides Consumer Infrared (CIR) support |
| Peripheral Interfaces | <ul style="list-style-type: none"> • Up to 12 USB 2.0 ports: <ul style="list-style-type: none"> — Eight ports routed to the back panel — Four ports routed to two USB headers • Up to two IEEE 1394a ports: <ul style="list-style-type: none"> — One port routed to the back panel — One port routed to an IEEE 1394a header • Six Serial ATA (SATA) channels (3.0 Gb/s) via ICH9R • Two external SATA (eSATA) channels via a discrete controller • One IDE interface with ATA-66/100 support (two devices) |
| RAID | <ul style="list-style-type: none"> • Intel® Matrix Storage Technology for Serial ATA |

continued

Table 1. Feature Summary (continued)

| | |
|----------------------------|---|
| LAN Support | Intel® 82566DC Gigabit (10/100/1000 Mb/s) Ethernet LAN controller including an RJ-45 back panel connector with integrated status LEDs |
| BIOS | <ul style="list-style-type: none">• Intel® Platform Innovation Framework for extensible firmware interface• 16 Mb symmetrical flash memory device• Support for SMBIOS• Intel® Rapid BIOS Boot• Intel® Express BIOS Update |
| Power Management | <ul style="list-style-type: none">• Support for Advanced Configuration and Power Interface (ACPI)• Suspend to RAM (STR)• Wake on USB, PCI, PCI Express, LAN, CIR, and front panel• ENERGY STAR* capable |
| Hardware Management | Hardware monitor with: <ul style="list-style-type: none">• Four fan sensing inputs used to monitor fan activity• Intel® Precision Cooling Technology fan speed control• Voltage sensing to detect out of range values |

Related Links:

For more information about Desktop Board DX38BT, including the Technical Product Specification (TPS), BIOS updates, and device drivers, go to:

<http://support.intel.com/support/motherboards/desktop/>

Supported Operating Systems

The Desktop Board supports the following operating systems:

- Microsoft Windows Vista* Ultimate
- Microsoft Windows Vista Enterprise
- Microsoft Windows Vista Business
- Microsoft Windows Vista Home Premium
- Microsoft Windows Vista Home Basic
- Microsoft Windows Vista Ultimate 64-bit edition
- Microsoft Windows Vista Enterprise 64-bit edition
- Microsoft Windows Vista Business 64-bit edition
- Microsoft Windows Vista Home Premium 64-bit edition
- Microsoft Windows Vista Home Basic 64-bit edition
- Microsoft Windows* XP Media Center Edition 2005
- Microsoft Windows XP Professional
- Microsoft Windows XP Professional x64 Edition
- Microsoft Windows XP Home

Desktop Board Components

Figure 1 shows the approximate location of the major components on Desktop Board DX38BT.

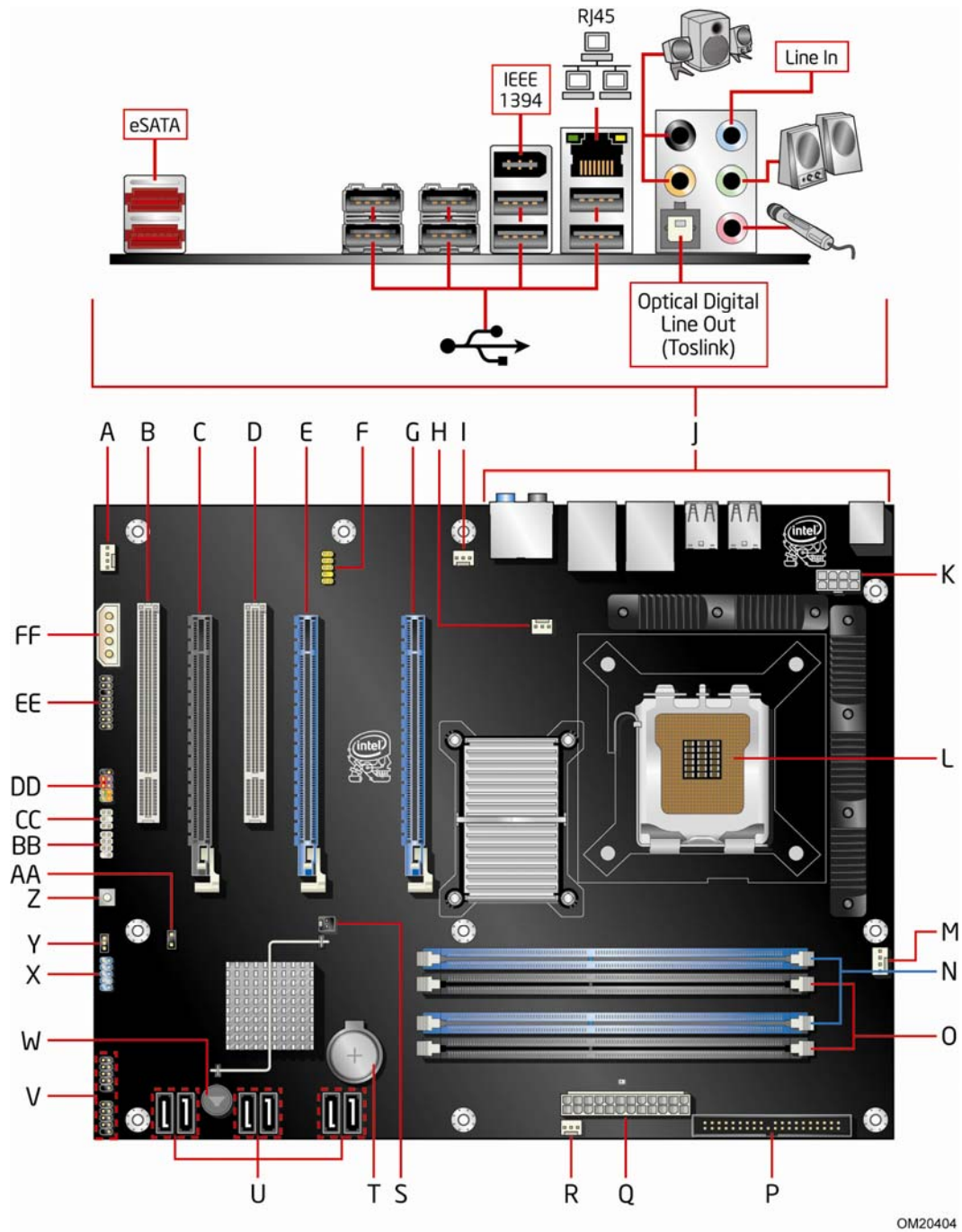

Figure 1. Desktop Board DX38BT Components

Table 2. Desktop Board DX38BT Components

| Label | Description |
|--------------|--|
| A | Rear chassis fan header 2 (4-pin) |
| B | PCI bus connector 2 |
| C | PCI Express 1.1 x16 (x4 electrical) connector |
| D | PCI bus connector 1 |
| E | PCI Express 2.0 x16 secondary connector |
| F | Front panel audio header |
| G | PCI Express 2.0 x16 primary connector |
| H | Rear chassis fan header (3-pin) |
| I | MCH fan header (3-pin) |
| J | Back panel connectors |
| K | 12 V processor core voltage connector (2 x 4 pin) |
| L | Processor socket |
| M | Processor fan header (4-pin) |
| N | DDR3 DIMM 0 sockets |
| O | DDR3 DIMM 1 sockets |
| P | IDE connector |
| Q | Main power connector (2 x 12 pin) |
| R | Front chassis fan header (3-pin) |
| S | Chassis intrusion header |
| T | Battery |
| U | Serial ATA connectors |
| V | USB 2.0 headers |
| W | Speaker |
| X | IEEE 1394a header |
| Y | BIOS configuration jumper block |
| Z | Onboard power button |
| AA | Alternate front panel power LED header |
| BB | Front panel CIR receiver (input) header |
| CC | Back panel CIR transmitter (output) header |
| DD | Front panel header |
| EE | High Definition Audio Link header |
| FF | Auxiliary PCI Express graphics power connector (1 x 4 pin) |

Related Links:

Go to the following links for more information about:

- Desktop Board DX38BT <http://www.intel.com/design/motherbd>
<http://support.intel.com/support/motherboards/desktop>
- Supported processors <http://www.intel.com/go/findCPU>
- Audio software and utilities <http://www.intel.com/design/motherbd>
- LAN software and drivers <http://www.intel.com/design/motherbd>

Processor



CAUTION

Failure to use an appropriate power supply and/or not connecting the 12 V (2 x 2 pin) power connector to the Desktop Board may result in damage to the board, or the system may not function properly.

Desktop Board DX38BT supports an Intel processor in the LGA775 package. Processors are not included with the Desktop Board and must be purchased separately. The processor connects to the Desktop Board through the LGA775 socket.

Related Links:

Go to the following page or link for more information about:

- Instructions on installing or upgrading the processor, page 33 in Chapter 2
- Supported processors for Desktop Board DX38BT,
<http://www.intel.com/go/findCPU>

Main Memory



NOTE

To be fully compliant with all applicable Intel® SDRAM memory specifications, the board should be populated with DIMMs that support the Serial Presence Detect (SPD) data structure. If your memory modules do not support SPD, you will see a notification to this effect on the screen at power up. The BIOS will attempt to configure the memory controller for normal operation.

The Desktop Board supports the dual or single channel memory configurations defined below:

- Four 240-pin Double Data Rate 3 (DDR3) SDRAM Dual Inline Memory Module (DIMM) connectors with gold-plated contacts.
- Unbuffered, non-registered single or double-sided DIMMs
- ECC and non-ECC DDR3 memory
- Serial Presence Detect (SPD) memory only
- Up to 4.0 GB utilizing 512 Mb or 1 Gb technology
- Up to 8.0 GB utilizing 1 Gb technology

Related Links:

Go to the following links or pages for more information about:

- SDRAM specifications, <http://www.intel.com/technology/memory/>
- Installing memory, page 39 in Chapter 2
- Tested memory, <http://www.cmtlabs.com/mbsearch.asp>

Intel® X38 Express Chipset

The Intel X38 Express Chipset consists of the following devices:

- Intel X38 Express Chipset Memory Controller Hub (MCH) with Direct Media Interface (DMI) interconnect
- Intel 82801IR I/O Controller Hub (ICH9R) with DMI interconnect

The MCH provides interfaces to the processor, memory, PCI Express bus, and the DMI interconnect. ICH9R is a centralized controller for the board's I/O paths.

Related Links:

Go to the following link for more information about the Intel X38 Express Chipset:

<http://developer.intel.com/products/chipsets/index.htm>

Audio Subsystem

The onboard audio subsystem consists of the following:

- Intel® ICH9R I/O controller hub
- IDT STAC9274D audio codec
- Back panel audio connectors
- Onboard audio headers:
 - Intel High Definition audio front panel header
 - HD Audio Link header

The audio subsystem supports the following features:

- Dolby* Home Theater support
- A signal-to-noise (S/N) ratio of 95 dB
- Independent multi-streaming 8-channel (7.1) audio (using the back panel audio connectors) and 2-channel audio (using the Intel High Definition audio front panel header)
- ADAT* optical interface support from the back panel S/PDIF optical port

Related Links:

Go to the following link or pages for more information about:

- Audio drivers and utilities <http://support.intel.com/support/motherboards/desktop/>
- The location of the onboard audio headers, Figure 27 on page 50
- The signal names for the Intel High Definition audio front panel header and the HD Audio Link header, page 51
- The back panel audio connectors, Figure 28 on page 55

LAN Subsystem

The LAN subsystem includes:

- Intel ICH9R
- Intel 82566DC Gigabit (10/100/1000 Mb/s) Ethernet LAN controller
- RJ-45 LAN connector with integrated status LEDs

The subsystem features:

- CSMA/CD protocol engine
- LAN connect interface between ICH9R and the LAN controller
- PCI bus power management

Related Links:

Go to the following link for information about LAN software and drivers:

<http://support.intel.com/support/motherboards/desktop/>

Two LEDs are built into the RJ-45 LAN connector located on the back panel (see Figure 2). These LEDs indicate the status of the LAN.

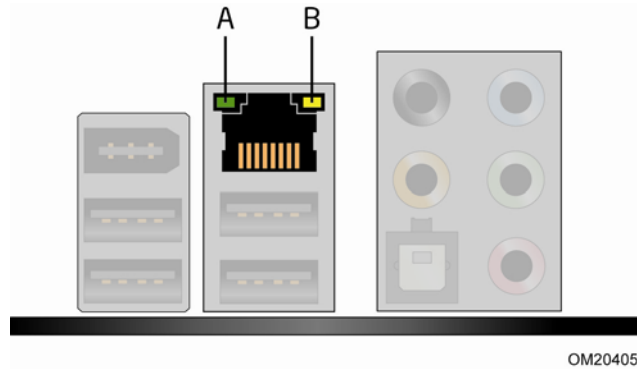

Figure 2. LAN Connector LEDs

Table 3 describes the LED states when the board is powered up and the LAN subsystem is operating.

Table 3. LAN Connector LEDs

| LED | LED Color | LED State | Indicates |
|-----|-----------|-----------|-----------------------------|
| A | Green | Off | LAN link is not established |
| | | On | LAN link is established |
| | | Blinking | LAN activity is occurring |
| B | N/A | Off | 10 Mb/s data rate |
| | Green | On | 100 Mb/s data rate |
| | Yellow | On | 1000 Mb/s data rate |

USB 2.0 Support

The Desktop Board supports up to 12 USB 2.0 ports (eight ports routed to back panel connectors and four ports routed to two onboard headers) via the ICH9R. USB 2.0 ports are backward compatible with USB 1.1 devices. USB 1.1 devices will function normally at USB 1.1 speeds.

USB 2.0 support requires both an operating system and drivers that fully support USB 2.0 transfer rates. Disabling Hi-Speed USB in the BIOS reverts all USB 2.0 ports to USB 1.1 operation. This may be required to accommodate operating systems that do not support USB 2.0.

Enhanced IDE Interface

The board's IDE interface handles the exchange of information between the processor and peripheral devices such as hard disk drives and CD-ROM drives. The interface supports:

- Up to two IDE devices (such as hard drives)
- ATAPI-style devices (such as CD-ROM drives)
- Older PIO Mode devices
- Ultra DMA-33 and ATA-66/100 protocols

Serial ATA

Desktop Board DX38BT supports six onboard Serial ATA channels (3.0 Gb/s) via ICH9R and two eSATA channels (3.0 Gb/s) via a discrete controller.

The six onboard Serial ATA channels provided by ICH9R support the following RAID (Redundant Array of Independent Drives) levels:

- RAID 0 - data striping
- RAID 1 - data mirroring
- RAID 0+1 (or RAID 10) - data striping and data mirroring
- RAID 5 - distributed parity

For information on configuring your system for RAID using Intel® Matrix Storage Technology see Chapter 4.

Legacy I/O

Desktop Board DX38BT includes an I/O controller that provides the following legacy I/O features:

- Consumer Infrared (CIR) support
- Low pin count (LPC) interface
- Intelligent power management, including a programmable wake up event interface
- PCI power management support

Expandability

Desktop Board DX38BT provides the following expansion capability:

- Two PCI Express 2.0 x16 ports
- One PCI Express 1.1 x4 port (routed to a x16 connector)
- Two PCI bus connectors

BIOS

The BIOS provides the Power-On Self-Test (POST), the BIOS Setup program, and the PCI/PCI Express and IDE auto-configuration utilities. The BIOS is stored in the Serial Peripheral Interface (SPI) Flash device.

The BIOS can be updated by following the instructions on page 65 in Chapter 3.

Serial ATA and IDE Auto Configuration

If you install a Serial ATA or IDE device (such as a hard drive) in your computer, the auto-configuration utility in the BIOS automatically detects and configures the device for your computer. You do not need to run the BIOS Setup program after installing a Serial ATA or IDE device. You can override the auto-configuration options by specifying manual configuration in the BIOS Setup program.

PCI and PCI Express* Auto Configuration

If you install a PCI/PCI Express add-in card in your computer, the PCI/PCI Express auto-configuration utility in the BIOS automatically detects and configures the resources (IRQs, DMA channels, and I/O space) for that add-in card. You do not need to run the BIOS Setup program after you install a PCI/PCI Express add-in card.

Security Passwords

The BIOS includes security features that restrict whether the BIOS Setup program can be accessed and who can boot the computer. A supervisor password and a user password can be set for the BIOS Setup and for booting the computer, with the following restrictions:

- The supervisor password gives unrestricted access to view and change all Setup options. If only the supervisor password is set, pressing <Enter> at the password prompt of Setup gives the user restricted access to Setup.
- If both the supervisor and user passwords are set, you must enter either the supervisor password or the user password to access Setup. Setup options are then available for viewing and changing depending on whether the supervisor or user password was entered.
- Setting a user password restricts who can boot the computer. The password prompt is displayed before the computer is booted. If only the supervisor password is set, the computer boots without asking for a password. If both passwords are set, you can enter either password to boot the computer.

Related Links:

For instructions on resetting the password, go to Clearing Passwords on page 59.

Hardware Management

The hardware management features of Desktop Board DX38BT enable the board to be compatible with the Wired for Management (WfM) specification. The board has several hardware management features including the following:

- Fan speed monitoring and control
- Thermal and voltage monitoring
- Chassis intrusion detection

Hardware Monitoring and Fan Speed Control

The features of the hardware monitoring and fan speed control include:

- Monitoring of power supply voltages to detect levels above and below acceptable values
- Intel® Precision Cooling Technology fan speed control, delivering acoustically-optimized thermal management
- Thermal sensors in the processor, MCH, and ICH9R, plus an onboard remote sensor



NOTE

The minimum thermal reporting threshold for the MCH is 66 °C. The MCH thermal sensor will report 66 °C until its temperature rises above this point.

- Thermally monitored closed-loop fan control, for all onboard fans, that can adjust fan speed or switch the fans off as needed

Intel® Precision Cooling Technology

Intel Precision Cooling Technology automatically adjust processor fan speed based on the processor temperature and adjusts chassis fan speeds based on the internal system temperature.

Chassis Intrusion

The board supports a chassis security feature that detects if the chassis cover has been removed. The security feature uses a mechanical switch on the chassis that can be connected to the chassis intrusion header on the Desktop Board. See Figure 27 for the location of the chassis intrusion header.

Power Management

Power management is implemented at several levels, including software support through the Advanced Configuration and Power Interface (ACPI) and the following hardware support:

- Power connectors
- Fan headers
- LAN wake capabilities
- Instantly Available PC technology (Suspend to RAM)
- +5 V standby power indicator LED
- Wake from USB
- Power Management Event signal (PME#) wakeup support
- WAKE# signal wake-up support
- ENERGY STAR capable

Software Support

ACPI

ACPI gives the operating system direct control over the power management and Plug and Play functions of a computer. The use of ACPI with the Desktop Board requires an operating system that provides full ACPI support.

Hardware Support

Power Connectors

ATX12V-compliant power supplies can turn off the computer power through system control. When an ACPI-enabled computer receives the correct command, the power supply removes all non-standby voltages.

When resuming from an AC power failure, the computer returns to the power state it was in before power was interrupted (either on or off). The computer's response can be set by using the Last Power State feature in the BIOS Setup program's Boot menu.

The Desktop Board has three power connectors. See Figure 30 on page 57 for the location of the power connectors.

Fan Headers

The function/operation of the fans is as follows:

- The fans are on when the computer is in the ACPI S0 state.
- The fans are off when the computer is in the ACPI S3, S4, or S5 state.
- Each fan header is wired to a tachometer input of the hardware monitoring and control device.
- All fan headers support closed-loop fan control that can adjust the fan speed or switch the fan on or off as needed.
- All fan headers have a +12 V DC connection.

The Desktop Board has a 4-pin processor fan header, one 4-pin and two 3-pin chassis fan headers, and one 3-pin MCH fan header.

LAN Wake Capabilities



CAUTION

For LAN wake capabilities, the 5 V standby line for the power supply must be capable of delivering adequate +5 V standby current. Failure to provide adequate standby current when using this feature can damage the power supply.

LAN wakeup capabilities enable remote wake-up of the computer through a network. The LAN subsystem monitors network traffic and upon detecting a Magic Packet* frame, it asserts a wake-up signal that powers up the computer.

Instantly Available PC Technology



CAUTIONS

For Instantly Available PC technology, the 5 V standby line for the power supply must be capable of delivering adequate +5 V standby current. Failure to provide adequate standby current when using this feature can damage the power supply and/or effect ACPI S3 sleep state functionality.

Power supplies used with this Desktop Board must be able to provide enough standby current to support the standard Instantly Available (ACPI S3 sleep state) configuration. If the standby current necessary to support multiple wake events from the PCI and/or USB buses exceeds power supply capacity, the Desktop Board may lose register settings stored in memory.

Instantly Available PC technology enables the board to enter the ACPI S3 (Suspend-to-RAM) sleep state. While in the S3 sleep state, the computer will appear to be off. If the computer has a dual-colored power LED on the front panel, the sleep state is indicated by the LED turning amber. When signaled by a wake-up device or event, the computer quickly returns to its last known awake state.

The Desktop Board supports the *PCI Bus Power Management Interface Specification*. Add-in cards that support this specification can participate in power management and can be used to wake the computer.

+5 V Standby Power Indicator



CAUTION

If the AC power has been switched off and the standby power indicator is still lit, disconnect the power cord before installing or removing any devices connected to the board. Failure to do so could damage the board and any attached devices.

The Desktop Board's standby power indicator, shown in Figure 3, is lit when there is standby power still present on the board even when the computer appears to be off. For example, when this LED is lit, standby power is still present at the memory module sockets and the PCI bus connectors.



Figure 3. Location of the Standby Power Indicator

Related Links:

For more information on standby current requirements for the Desktop Board, refer to the Technical Product Specification by going to the following link, finding the product, and selecting Product Documentation from the left-hand menu:

<http://support.intel.com/support/motherboards/desktop/>

Wake from USB



NOTE

Wake from USB requires the use of a USB peripheral that supports Wake from USB and an operating system that supports Wake from USB..

USB bus activity wakes the computer from an ACPI S3 state.

PME# Signal Wake-up Support

When the PME# signal on the PCI bus is asserted, the computer wakes from an ACPI S1, S3, S4, or S5 state.

WAKE# Signal Wake-up Support

When the WAKE# signal on the PCI Express bus is asserted, the computer wakes from an ACPI S1, S3, S4, or S5 state.

ENERGY STAR* Capable

In 2007, the US Department of Energy and the US Environmental Protection Agency revised the ENERGY STAR requirements. Intel worked directly with these two governmental agencies to define the new requirements. Currently Intel Desktop Boards are capable of meeting the new ENERGY STAR requirements depending upon system configuration.

Go to the following link for information and recommendations concerning the new ENERGY STAR requirements: <http://www3.intel.com/cd/channel/reseller/asmo-na/eng/337748.htm>.

Onboard Power Button

CAUTION

Electrostatic discharge (ESD) can damage components. Perform the procedure described in this section only at an ESD workstation using an antistatic wrist strap and a conductive foam pad. If such a station is not available, you can provide some ESD protection by wearing an antistatic wrist strap and attaching it to a metal part of the computer chassis.

A power button on the Desktop Board (see Figure 4) can be used to turn the computer on or off. This button is intended for use at integration facilities to remove standby power before making changes to the system configuration, or for testing purposes. The power button on the front panel is recommended for all other instances of turning the computer on or off. To turn off the computer using the onboard power button, keep the button pressed down for three seconds.

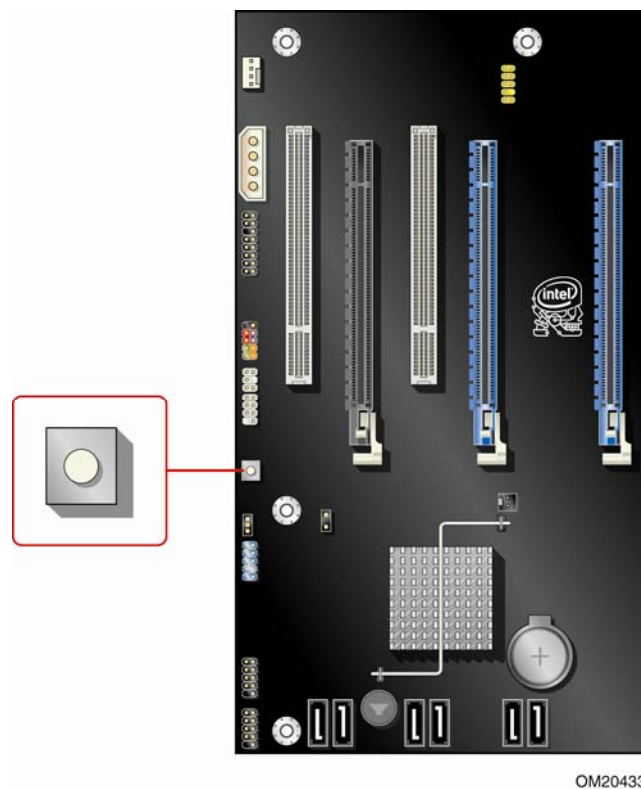
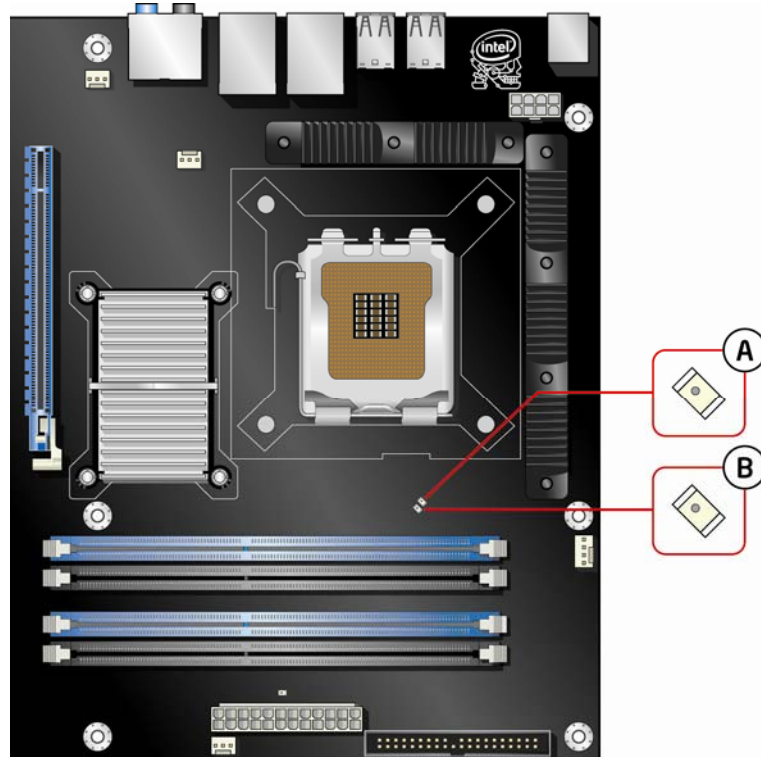

Figure 4. Onboard Power Button

Onboard VR and CPU LEDs

In addition to the standby power indicator (see Figure 3), the Desktop Board contains two other LEDs (see Figure 5):

- The VR LED (Figure 5, A) indicates an elevated temperature in the processor voltage regulator circuit that could affect performance.
- The CPU LED (Figure 5, B) indicates an elevated temperature on the processor that could affect performance.



OM20427

Figure 5. Location of the VR and CPU LEDs

Speaker

A speaker is mounted on the Desktop Board. The speaker provides audible error code (beep code) information during the Power-On Self-Test (POST). Refer to Appendix A for a description of the board's beep codes.

Battery

A battery on the Desktop Board keeps the values in CMOS RAM and the clock current when the computer is turned off. Go to page 60 for instructions on how to replace the battery.

Real-Time Clock

The Desktop Board has a time-of-day clock and 100-year calendar. The battery on the Desktop Board keeps the clock current when the computer is turned off.

2 Installing and Replacing Desktop Board Components

This chapter tells you how to:

- Install the I/O shield
- Install and remove the Desktop Board
- Install and remove a processor
- Install the ICH heat sink decorative cover
- Install an MCH heat sink fan
- Install and remove memory
- Install and remove a PCI Express x16 card
- Connect the IDE and Serial ATA cables
- Connect to the internal headers
- Connect to the audio system
- Connect chassis fan and power supply cables
- Set the BIOS configuration jumper
- Clear passwords
- Replace the battery

Before You Begin



CAUTIONS

The procedures in this chapter assume familiarity with the general terminology associated with personal computers and with the safety practices and regulatory compliance required for using and modifying electronic equipment.

Disconnect the computer from its power source and from any telecommunications links, networks, or modems before performing any of the procedures described in this chapter. Failure to disconnect power, telecommunications links, networks, or modems before you open the computer or perform any procedures can result in personal injury or equipment damage. Some circuitry on the board can continue to operate even though the front panel power button is off.

Follow these guidelines before you begin:

- Always follow the steps in each procedure in the correct order.
- Set up a log to record information about your computer, such as model, serial numbers, installed options, and configuration information.
- Electrostatic discharge (ESD) can damage components. Perform the procedures described in this chapter only at an ESD workstation using an antistatic wrist strap and a conductive foam pad. If such a station is not available, you can provide some ESD protection by wearing an antistatic wrist strap and attaching it to a metal part of the computer chassis.

Installation Precautions

When you install and test the Intel Desktop Board, observe all warnings and cautions in the installation instructions.

To avoid injury, be careful of:

- Sharp pins on connectors
- Sharp pins on printed circuit assemblies
- Rough edges and sharp corners on the chassis
- Hot components (such as processors, voltage regulators, and heat sinks)
- Damage to wires that could cause a short circuit

Observe all warnings and cautions that instruct you to refer computer servicing to qualified technical personnel.

Prevent Power Supply Overload

Do not overload the power supply output. To avoid overloading the power supply, make sure that the calculated total current loads of all the modules within the computer is less than the output current rating of each of the power supplies output circuits.

Observe Safety and Regulatory Requirements

Read and follow the instructions in this section and the instructions supplied with the chassis and associated modules. If you do not follow these instructions and the instructions provided by the chassis and module suppliers, you increase your safety risk and the possibility of noncompliance with regional laws and regulations. If the instructions for the chassis are inconsistent with these instructions or the instructions for associated modules, contact the supplier to find out how you can ensure that your computer meets safety and regulatory requirements.

Related Links

For information about the Desktop Board's regulatory compliance, go to Appendix B on page 73.

Installing the I/O Shield

The Desktop Board comes with an I/O shield. When installed in the chassis, the shield blocks radio frequency transmissions, protects internal components from dust and foreign objects, and promotes correct airflow within the chassis.

Install the I/O shield before installing the Desktop Board in the chassis. Place the shield inside the chassis as shown in Figure 6. Press the shield into place so that it fits tightly and securely. If the shield does not fit, obtain a properly sized shield from the chassis supplier.

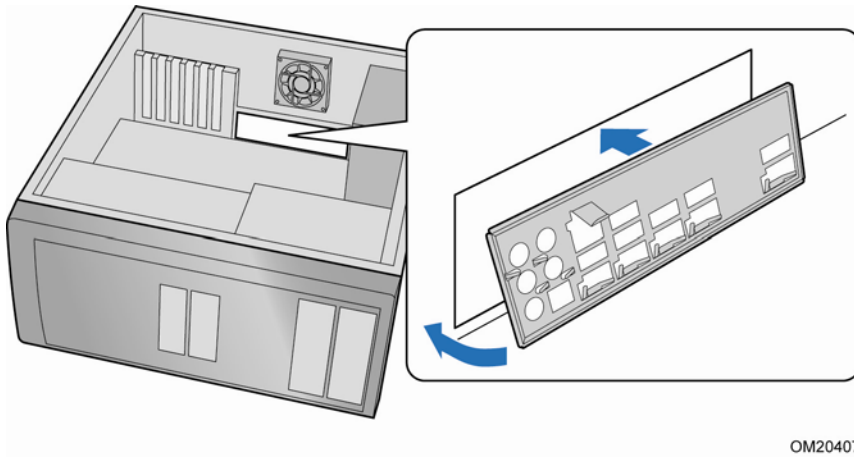

OM20407

Figure 6. Installing the I/O Shield

Installing and Removing the Desktop Board



CAUTION

Only qualified technical personnel should perform this procedure. Disconnect the computer from its power source before performing the procedures described here. Failure to disconnect the power before you open the computer can result in personal injury or equipment damage.

Refer to your chassis manual for instructions on installing and removing the Desktop Board.

Figure 7 shows the location of the mounting screw holes for Desktop Board DX38BT.

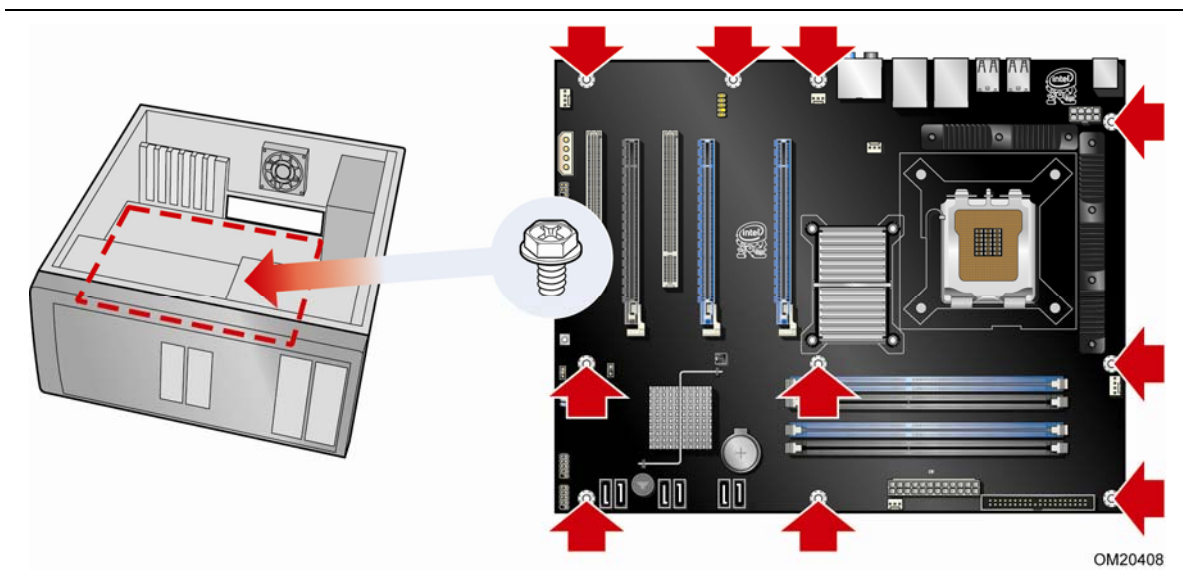

Figure 7. Desktop Board DX38BT Mounting Screw Hole Locations

Installing and Removing a Processor

Instructions on how to install the processor on the Desktop Board are given below.

Installing a Processor



CAUTION

Before installing or removing a processor, make sure the AC power has been removed by unplugging the power cord from the computer; the standby power LED should not be lit (see Figure 3 on page 23). Failure to do so could damage the processor and the board.

To install a processor, follow these instructions:

1. Observe the precautions in "Before You Begin" on page 29.
2. Open the socket lever by pushing the lever down and away from the socket (Figure 8, A and B).

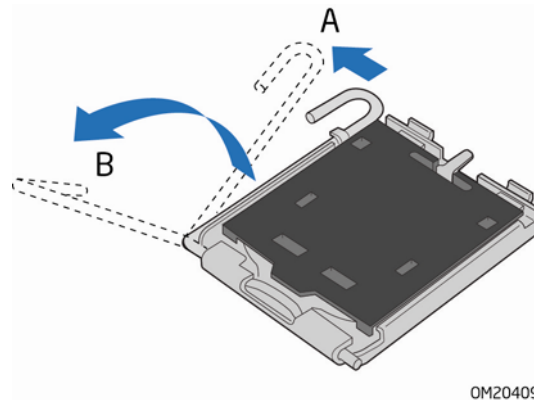

Figure 8. Lift the Socket Lever

3. Lift the load plate (Figure 9, A). Do not touch the socket contacts (Figure 9, B).

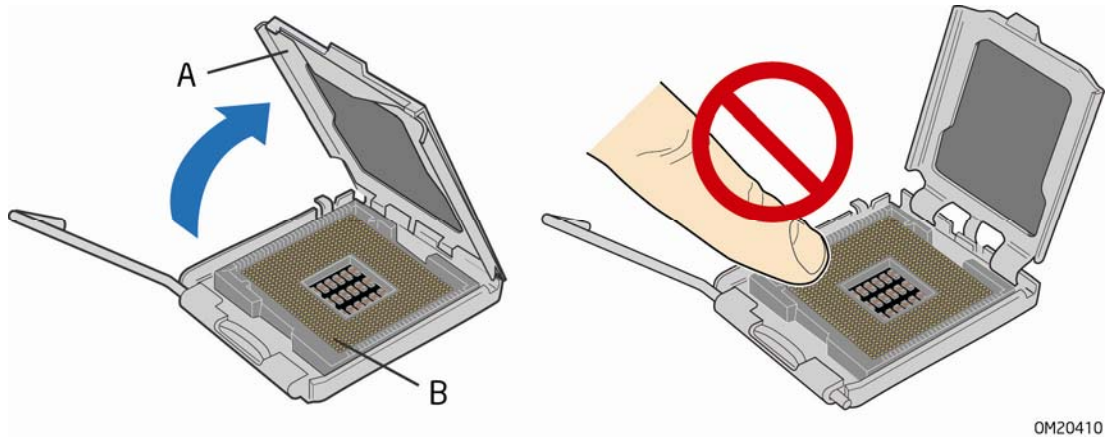

Figure 9. Lift the Load Plate

4. Remove the plastic protective socket cover from the load plate (Figure 10). Do not discard the protective socket cover. Always replace the socket cover if the processor is removed from the socket.

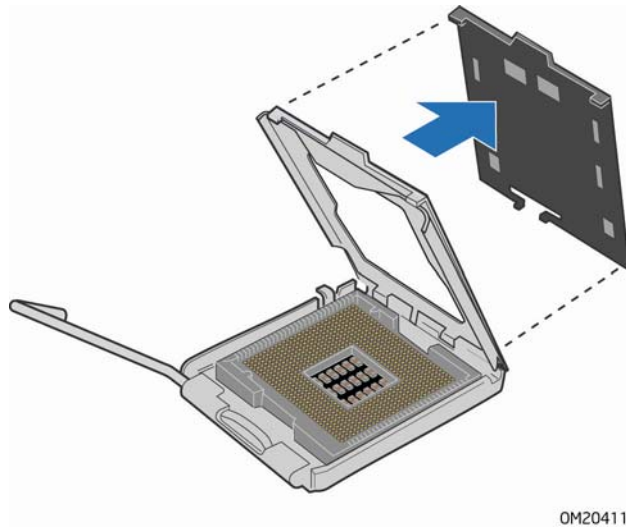

Figure 10. Remove the Protective Socket Cover

5. Remove the processor from the protective processor cover. Hold the processor only at the edges, being careful not to touch the bottom of the processor (see Figure 11). Do not discard the protective processor cover. Always replace the processor cover if the processor is removed from the socket.



OM20412

Figure 11. Remove the Processor from the Protective Processor Cover

6. Hold the processor with your thumb and index fingers oriented as shown in Figure 12. Make sure your fingers align to the socket cutouts (Figure 12, A). Align notches (Figure 12, B) with the socket (Figure 12, C). Lower the processor straight down without tilting or sliding it in the socket.

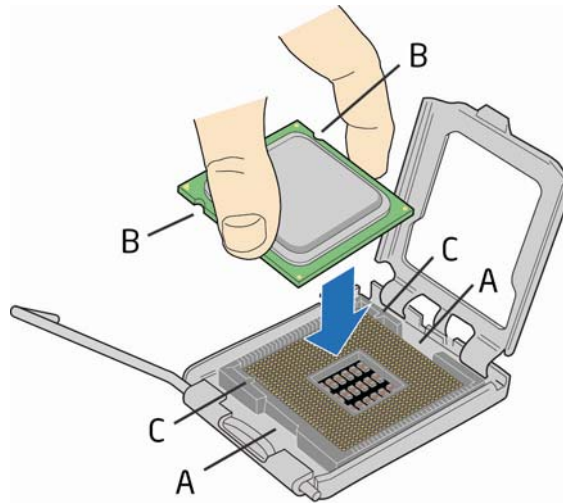

OM20413

Figure 12. Install the Processor

7. Pressing down on the load plate (Figure 13, A), close and engage the socket lever (Figure 13, B).

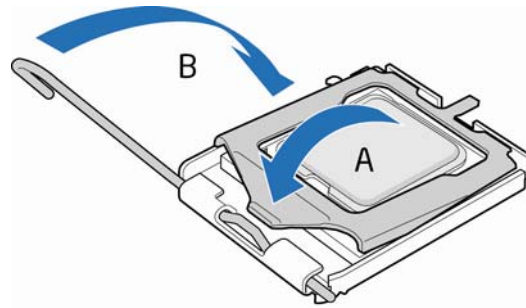

OM20414

Figure 13. Close the Load Plate

Installing the Processor Fan Heat Sink

Desktop Board DX38BT has mounting holes for a processor fan heat sink. For instructions on how to attach the processor fan heat sink to the Desktop Board, refer to the boxed processor manual.

Connecting the Processor Fan Heat Sink Cable

Connect the processor fan heat sink cable to the 4-pin processor fan header (see Figure 14). A fan with a 4-pin connector as shown in Figure 14, A is recommended; however, a fan with a 3-pin connector (Figure 14, B) can be used. However, since the fan with a 3-pin connector cannot use the onboard fan control, the fan will always operate at full speed.

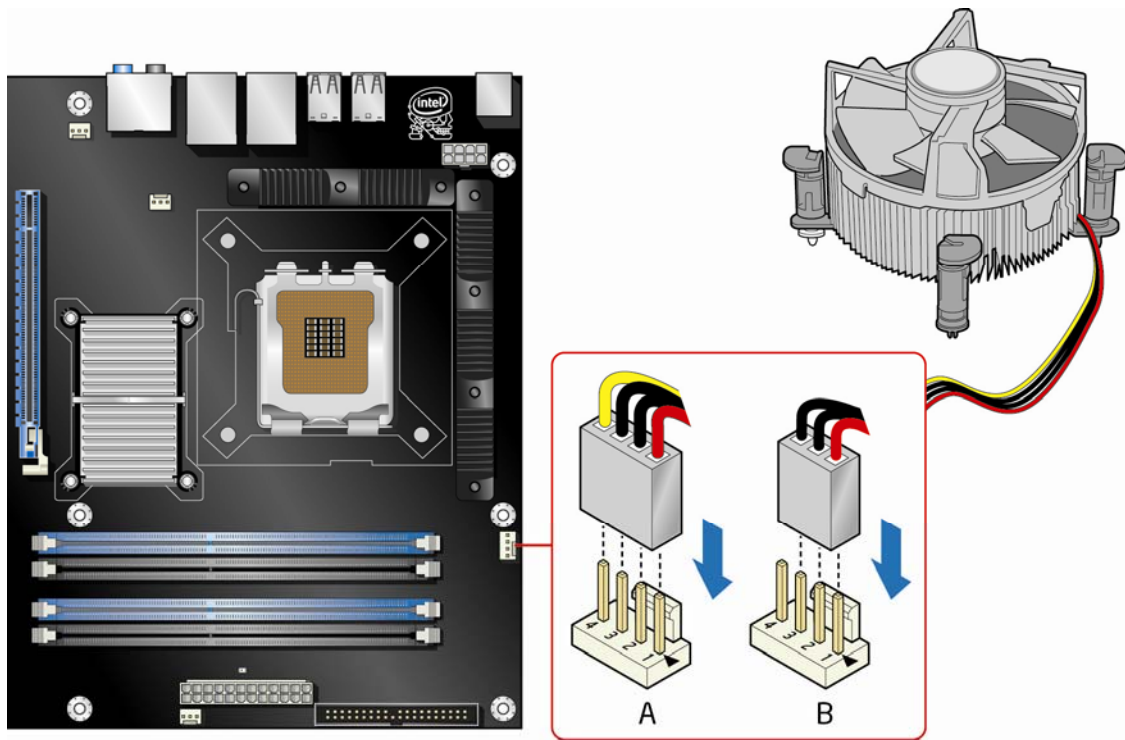

OM20428

Figure 14. Connecting the Processor Fan Heat Sink Cable to the Processor Fan Header

Removing the Processor

For instructions on how to remove the processor fan heat sink and processor, refer to the processor installation manual.

Installing the ICH Heat Sink Decorative Cover (Optional)

To install the ICH heat sink decorative cover, follow these instructions:

1. Observe the precautions in "Before You Begin" on page 29.
2. Remove the paper covering the adhesive strip on the bottom of the heat sink cover (Figure 15, A).
3. Place the heat sink cover on the ICH heat sink (Figure 15, B). Press down firmly to ensure that the adhesive adheres to the heat sink.

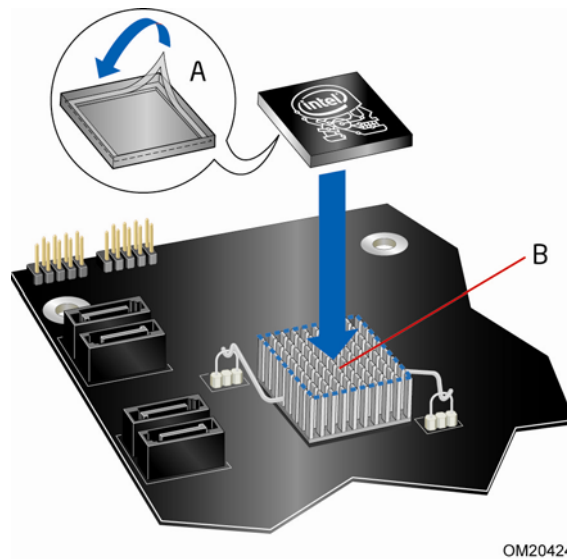

OM20424

Figure 15. Installing the ICH Heat Sink Decorative Cover

Installing an MCH Heat Sink Fan (Optional)

If your system application requires more MCH cooling than that provided by the MCH passive heat sink, you can add a fan to the heat sink by using the included MCH heat sink fan mounting bracket. This fan mounting bracket is designed to accommodate a 40 mm x 10 mm or 40 mm x 20 mm, 12 V dc fan. You can use the board's 3-pin MCH fan header to supply power to the MCH fan.



NOTE

An MCH heat sink fan is not included with Desktop Board DX38BT and must be purchased separately.

To install an MCH heat sink fan, follow these instructions:

1. Observe the precautions in "Before You Begin" on page 29.
2. Attach the fan (Figure 16, A) to the fan mounting bracket (Figure 16, B) using the fasteners (Figure 16, A) supplied with the fan. Slide the four legs of the bracket over the heat sink fins (Figure 16, C) and push down until the bracket "clicks" into place.
3. Attach the fan power connector to the MCH fan header (Figure 16, D).

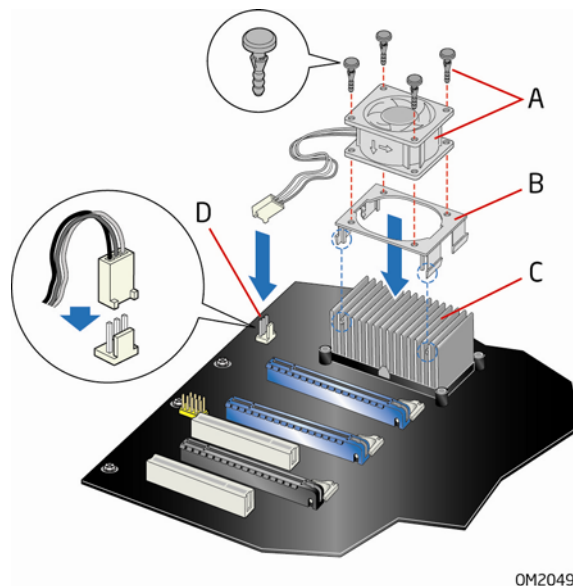

OM20494

Figure 16. Installation of a Typical MCH Heat Sink Fan

Installing and Removing Memory



NOTE

To be fully compliant with all applicable Intel SDRAM memory specifications, the board requires DIMMs that support the Serial Presence Detect (SPD) data structure.

Desktop board DX38BT has four 240-pin DDR3 DIMM sockets arranged as DIMM 0 and DIMM 1 in both Channel A and Channel B.



NOTE

Regardless of the memory configuration used (dual or single channel), Channel A, DIMM 0 must always be populated. This is a requirement of the ICH9R Manageability Engine feature.

Guidelines for Dual Channel Memory Configuration

Before installing DIMMs, read and follow these guidelines for dual channel configuration.

Two or Four DIMMs

Install a matched pair of DIMMs equal in speed and size (see Figure 17) in DIMM 0 (blue) of channels A and B.



OM20429

Figure 17. Dual Channel Memory Configuration with Two DIMMs

If additional memory is to be used, install another matched pair of DIMMs in DIMM 1 (black) in channels A and B (see Figure 18).



Figure 18. Dual Channel Memory Configuration with Four DIMMs

Three DIMMs

If you want to use three DIMMs in a dual-channel configuration, install a matched pair of DIMMs equal in speed and size in DIMM 0 (blue) and DIMM 1 (black) of channel A. Install a DIMM equal in speed and total size of the DIMMs installed in channel A in either DIMM 0 or DIMM 1 of channel B (see Figure 19).



Figure 19. Dual Channel Memory Configuration with Three DIMMs



NOTE

All other memory configurations will result in single channel memory operation.

Installing DIMMs

To make sure you have the correct DIMM, place it on the illustration of the DDR3 DIMM in Figure 20. All the notches should match with the DDR3 DIMM.

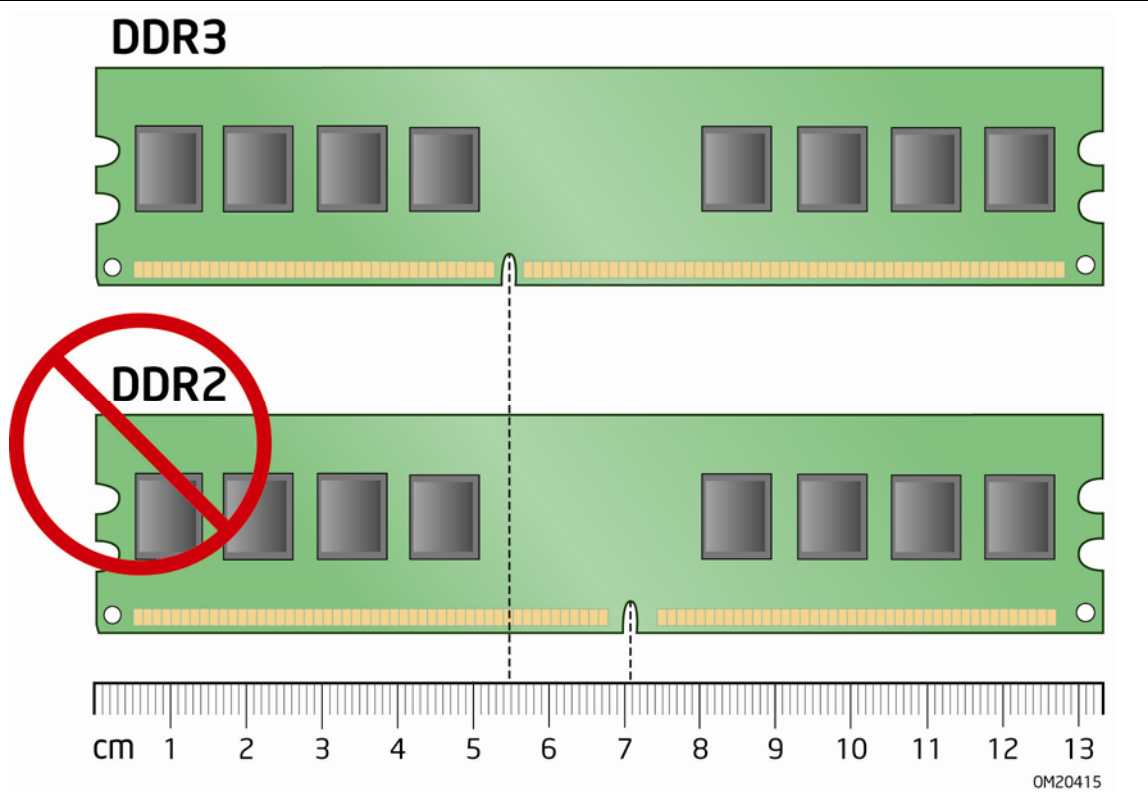
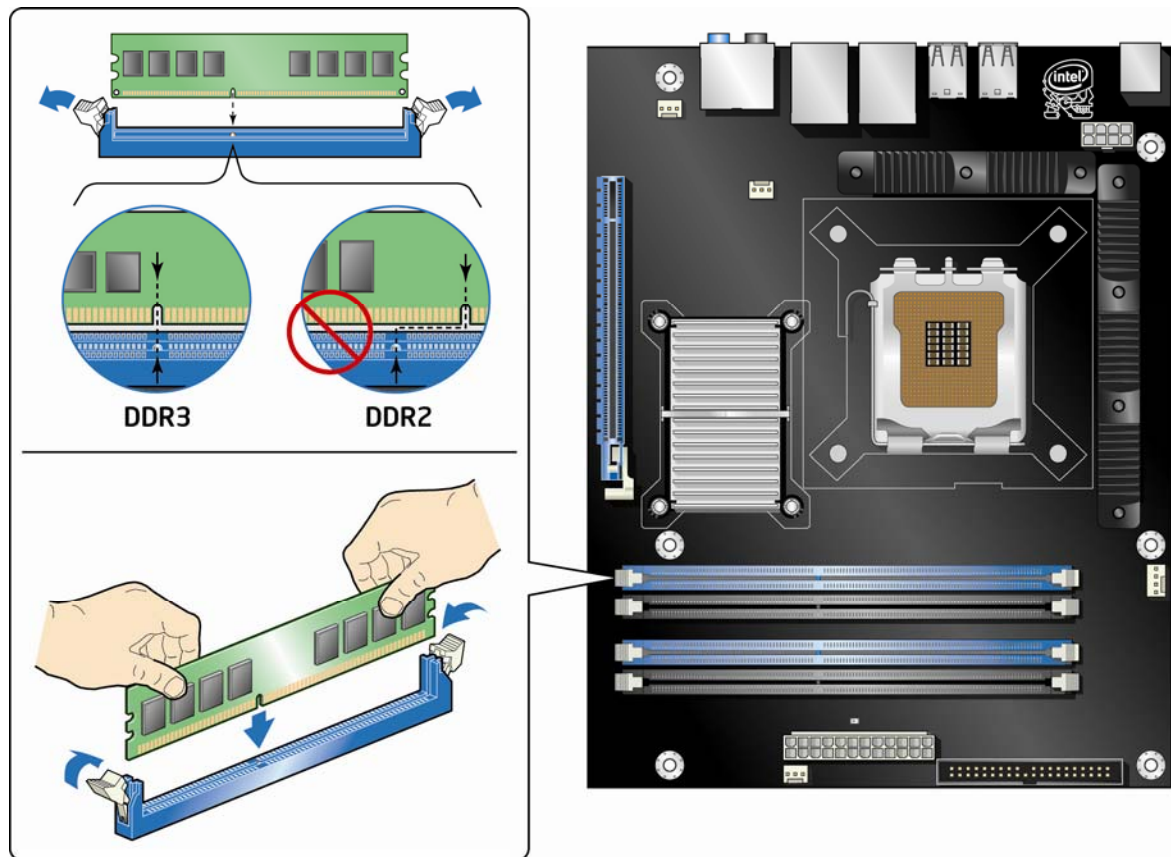

Figure 20. Use DDR3 DIMMs

To install a DIMM, follow these steps:

1. Observe the precautions in "Before You Begin" on page 29.
2. Turn off all peripheral devices connected to the computer. Turn off the computer and disconnect the AC power cord.
3. Remove the computer's cover and locate the DIMM sockets (see Figure 21).



OM20416

Figure 21. Installing a DIMM

4. Make sure the clips at either end of the DIMM socket(s) are pushed outward to the open position.
5. Holding the DIMM by the edges, remove it from its anti-static package.
6. Position the DIMM above the socket. Align the small notch at the bottom edge of the DIMM with the keys in the socket (see inset in Figure 21).
7. Insert the bottom edge of the DIMM into the socket.
8. When the DIMM is inserted, push down on the top edge of the DIMM until the retaining clips snap into place. Make sure the clips are firmly in place.
9. Replace the computer's cover and reconnect the AC power cord.

Removing DIMMs

To remove a DIMM, follow these steps:

1. Observe the precautions in "Before You Begin" on page 29.
2. Turn off all peripheral devices connected to the computer. Turn off the computer.
3. Remove the AC power cord from the computer.
4. Remove the computer's cover.
5. Gently spread the retaining clips at each end of the DIMM socket. The DIMM pops out of the socket.
6. Hold the DIMM by the edges, lift it away from the socket, and store it in an anti-static package.
7. Reinstall and reconnect any parts you removed or disconnected to reach the DIMM sockets.
8. Replace the computer's cover and reconnect the AC power cord.

Installing and Removing a PCI Express x16 Card

CAUTION

When installing a PCI Express card on the Desktop Board, ensure that the card is fully seated in the PCI Express connector before you power on the system. If the card is not fully seated in the connector, an electrical short may result across the connector pins. Depending on the over-current protection of the power supply, certain Desktop Board components and/or traces may be damaged.

Installing Multiple PCI Express x16 Graphics Cards

If you are installing a single PCI Express x16 graphics card, install it in the PCI Express primary connector (Figure 22, A) for optimum performance. However, if you are installing two PCI Express x16 graphics cards, install them in the PCI Express x16 primary (Figure 22, A) and secondary connectors (Figure 22, B).

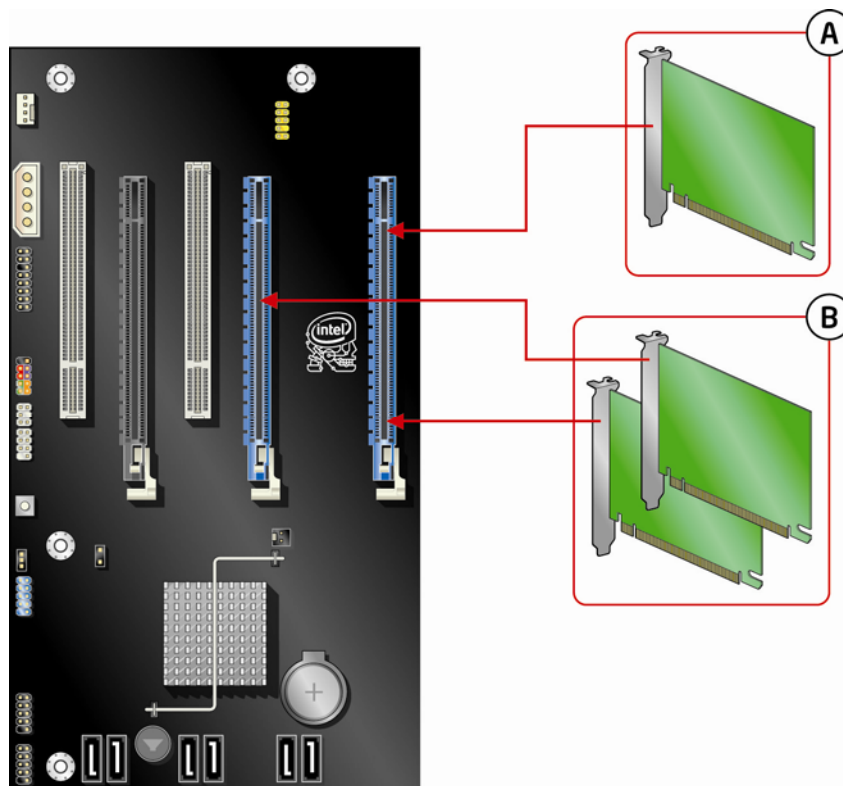

OM20432

Figure 22. Installing PCI Express x16 Graphics Cards

Installing a PCI Express x16 Card

Follow these instructions to install any PCI Express x16 card:

1. Observe the precautions in "Before You Begin" on page 29.
2. Place the card in a PCI Express x16 connector (Figure 23, A) and press down on the card until it is completely seated in the connector and the card retention notch on the card snaps into place around the retention mechanism pin on the connector.
3. Secure the card's metal bracket to the chassis back panel with a screw (Figure 23, B).

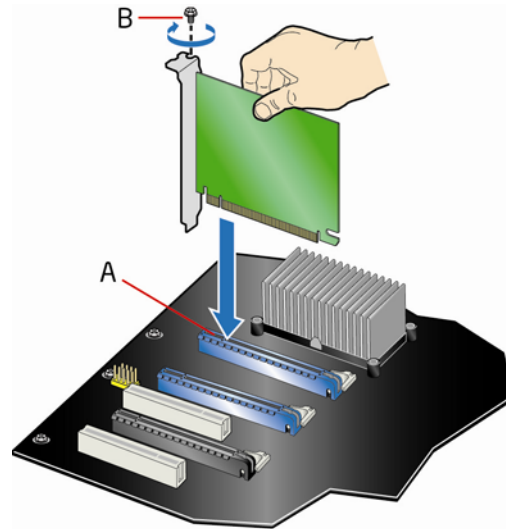

OM20417

Figure 23. Installing a PCI Express x16 Card

Removing a PCI Express x16 Card

Follow these instructions to remove a PCI Express x16 card from a connector:

1. Observe the precautions in "Before You Begin" on page 29.
2. Remove the screw (Figure 24, A) that secures the card's metal bracket to the chassis back panel.
3. Push the card ejector lever down using the tip of a pencil or similar tool (Figure 24, B) in the notch. This will release the card from the connector (C).
4. Pull the card straight up.

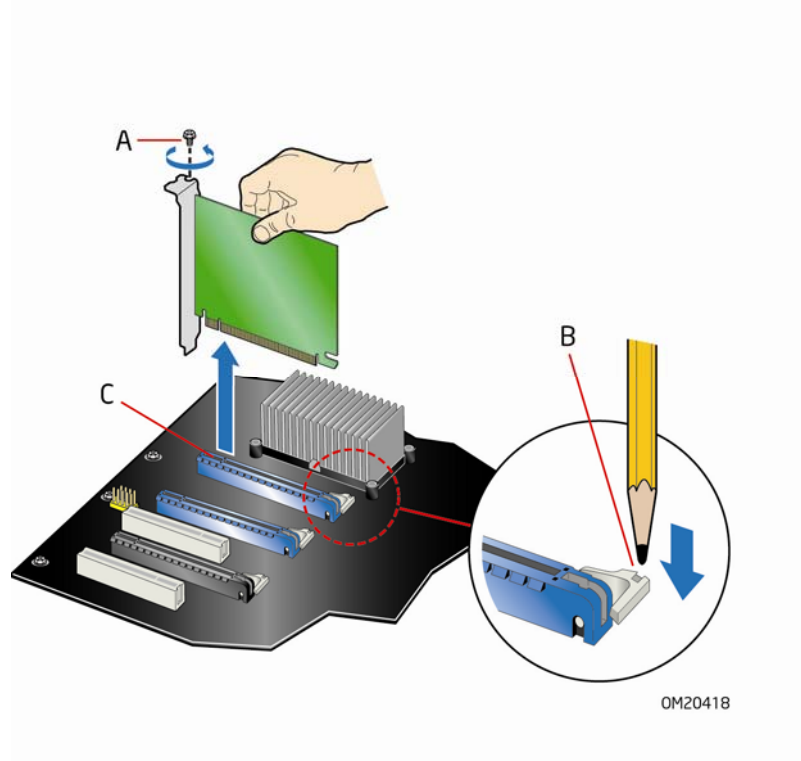

Figure 24. Removing a PCI Express x16 Card

Connecting the IDE Cable

The IDE cable can be used to connect two IDE drives to the Desktop Board. The cable supports the ATA-66/100 transfer protocol. Figure 25 shows the correct installation of the cable.



NOTES

ATA-66/100 compatible cables are backward compatible with drives using slower IDE transfer protocols. If an ATA-66/100 disk drive and a disk drive using any other IDE transfer protocol are attached to the same cable, the maximum transfer rate between the drives may be reduced to that of the slowest drive.

Do not connect an ATA device as a slave on the same IDE cable as an ATAPI master device. For example, do not connect an ATA hard drive as a slave to an ATAPI CD-ROM drive.

For correct function of the cable:

- Observe the precautions in "Before You Begin" on page 29.
- Attach the cable end with the single connector (blue) to the Intel Desktop Board (Figure 25, A).
- Attach the cable end with the two closely spaced connectors (gray and black) to the drives (Figure 25, B).

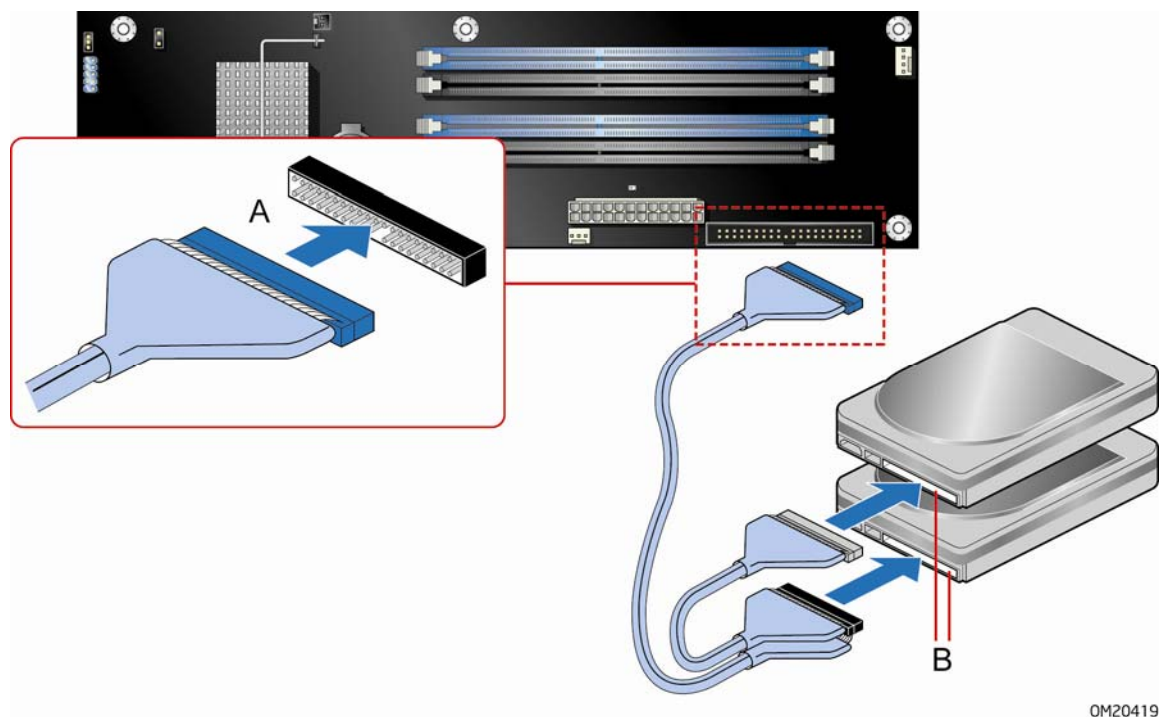

0M20419

Figure 25. Connecting the IDE Cable

Connecting the Serial ATA (SATA) Cables

SATA cables support the Serial ATA protocol. Each cable can be used to connect one internal SATA drive to the Desktop Board. For correct cable function:

1. Observe the precaution in "Before You Begin" on page 29.
2. Attach one end of the SATA cable to one of the SATA connectors on the board (Figure 26, A) and attach the other end of the cable to the SATA drive (Figure 26, B).

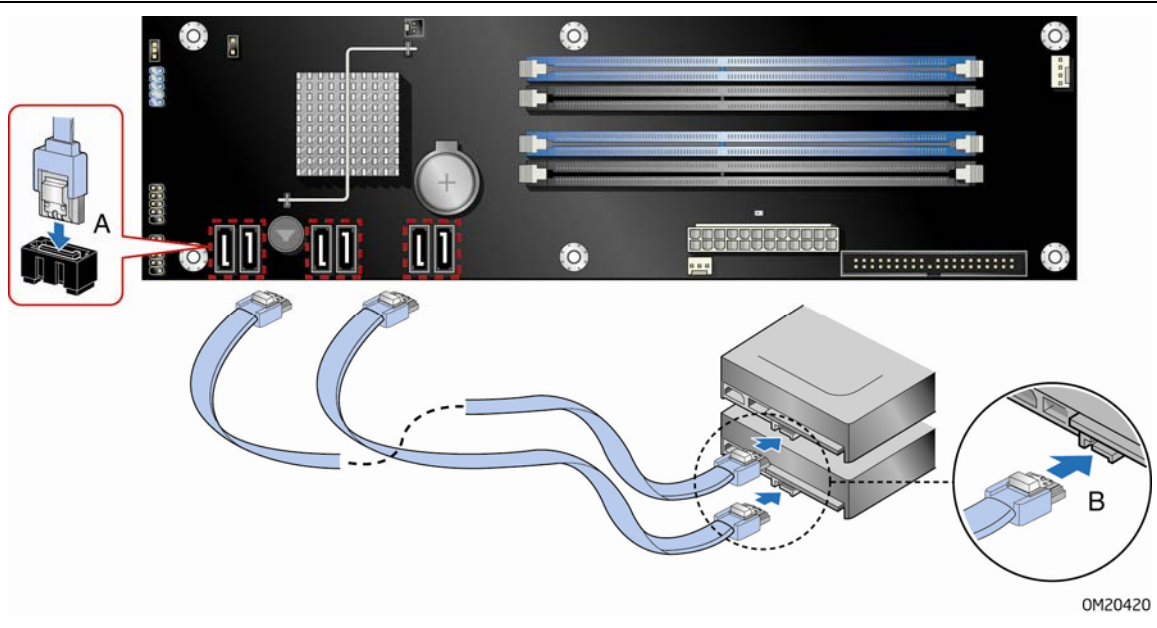
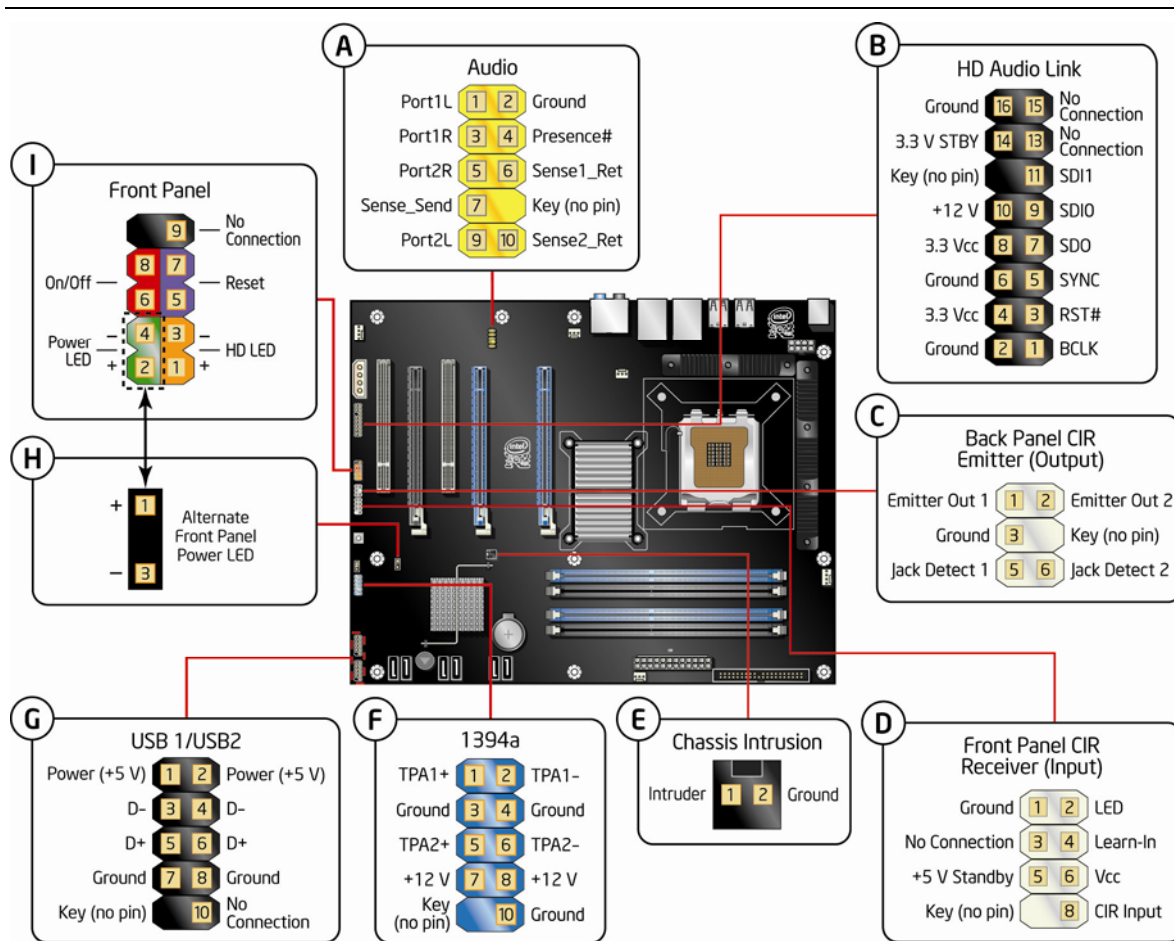

Figure 26. Connecting a Serial ATA Cable

Connecting to the Internal Headers

Before connecting cables to any of the internal headers, observe the precautions in “Before You Begin” on page 29. Figure 27 shows the location of the internal headers.



OM20421

| Item | Description | Item | Description |
|------|----------------------------------|------|---------------------------------|
| | Front panel audio | | IEEE 1394a |
| | HD Audio Link | | USB 2.0 (2) |
| | Back panel CIR emitter (output) | | Alternate front panel power LED |
| | Front panel CIR receiver (input) | | Front panel |
| | Chassis intrusion | | |

Figure 27. Internal Headers

Front Panel Audio Header

Figure 27, A shows the location of the front panel audio header. Table 4 shows the pin assignments and signal names for the front panel audio header.

Table 4. Front Panel Audio Header Signal Names

| Pin | Signal Name | Pin | Signal Name |
|-----|-------------|-----|---------------|
| 1 | PORT 1L | 2 | GND |
| 3 | PORT 1R | 4 | PRESENCE# |
| 5 | PORT 2R | 6 | SENSE1_RETURN |
| 7 | SENSE_SEND | 8 | KEY (no pin) |
| 9 | PORT 2L | 10 | SENSE2_RETURN |

HD Audio Link Header

Figure 27, B shows the location of the HD Audio Link header. Table 5 shows the pin assignments and signal names for the HD Audio Link header.

Table 5. HD Audio Link Header Signal Names

| Pin | Signal Name | Pin | Signal Name |
|-----|---------------|-----|-------------|
| 1 | BCLK | 2 | Ground |
| 3 | RST# | 4 | 3.3 Vcc |
| 5 | SYNC | 6 | Ground |
| 7 | SDO | 8 | 3.3 Vcc |
| 9 | SDI0 | 10 | +12 V |
| 11 | SDI1 | 12 | Key |
| 13 | No Connection | 14 | 3.3 V STBY |
| 15 | No Connection | 16 | Ground |

Consumer IR (CIR) Headers

The Desktop Board has two CIR headers: the input or receiver header (Figure 27, D) and the output or emitter header (Figure 27, C). The receiver header consists of a filtered translated infrared input compliant with Microsoft CIR specifications and a "learning" infrared input. The learning input is a high-pass input which the computer can use to "learn" to speak the infrared communication language of other user remotes. The emitter header consists of two output ports which the computer can use to emulate "learned" infrared commands in order to control external electronic hardware.

**NOTE**

The Consumer IR option must be enabled in the system BIOS before it can function. Press <F2> at boot to enter the system BIOS, and go to Advanced > Peripheral Configuration > Enhanced Consumer IR, and set this option to Enabled.

Table 6 shows the pin assignments and signal names for the front panel CIR receiver (input) header and Table 7 shows the pin assignments and signal names for the back panel CIR emitter (output) header.

Table 6. Front Panel CIR Receiver (Input) Header Signal Names

| Pin | Signal Name | Pin | Signal Name |
|-----|---------------|-----|-------------|
| 1 | Ground | 2 | LED |
| 3 | No Connection | 4 | Learn-In |
| 5 | +5 V Standby | 6 | Vcc |
| 7 | Key (no pin) | 8 | CIR Input |

Table 7. Back Panel CIR Header Emitter (Output) Header Signal Names

| Pin | Signal Name | Pin | Signal Name |
|-----|---------------|-----|---------------|
| 1 | Emitter Out 1 | 2 | Emitter Out 2 |
| 3 | Ground | 4 | Key (no pin) |
| 5 | Jack Detect 1 | 6 | Jack Detect 2 |

Chassis Intrusion Header

Figure 27, E shows the location of the chassis intrusion header. This header can be connected to a mechanical switch on the chassis to detect if the chassis cover is removed.

Table 8 shows the pin assignments and signal names for the chassis intrusion header.

Table 8. Chassis Intrusion Header Signal Names

| Pin | Description |
|-----|-------------|
| 1 | Intruder |
| 2 | Ground |

IEEE 1394a Header

Figure 27, F shows the location of the IEEE 1394a header. Table 9 shows the pin assignments and signal names for the IEEE 1394a header.

Table 9. IEEE 1394a Header Signal Names

| Pin | Signal Name | Pin | Signal Name |
|-----|--------------|-----|-------------|
| 1 | TPA1+ | 2 | TPA1- |
| 3 | Ground | 4 | Ground |
| 5 | TPA2+ | 6 | TPA2- |
| 7 | +12 V | 8 | +12 V |
| 9 | Key (no pin) | 10 | Ground |

USB 2.0 Headers

Figure 27, G shows the location of the USB 2.0 headers. Table 10 shows the pin assignments and signal names for each USB 2.0 header. Each USB header can be used to connect two USB devices.

Table 10. USB 2.0 Header Signal Names

| USB Port A | | USB Port B | |
|------------|--------------|------------|---------------|
| Pin | Signal Name | Pin | Signal Name |
| 1 | Power (+5 V) | 2 | Power (+5 V) |
| 3 | D- | 4 | D- |
| 5 | D+ | 6 | D+ |
| 7 | Ground | 8 | Ground |
| 9 | Key | 10 | No Connection |

Note: USB ports may be assigned as needed.



NOTE

Computer systems that have an unshielded cable attached to a USB port might not meet FCC Class B requirements, even if no device or a low-speed USB device is attached to the cable. Use a shielded cable that meets the requirements for a full-speed USB device.

Front Panel Header

Figure 27, I shows the location of the front panel header. Table 11 shows the pin assignments and signal names for the front panel header.

Table 11. Front Panel Header Signal Names

| Pin | Description | In/Out | Pin | Description | In/Out |
|--------------------------------|-------------------------------|--------|----------------------|------------------------|--------|
| Hard Drive Activity LED | | | Power LED | | |
| 1 | Hard disk LED pull-up to +5 V | Out | 2 | Front panel green LED | Out |
| 3 | Hard disk active LED | Out | 4 | Front panel yellow LED | Out |
| Reset Switch | | | On/Off Switch | | |
| 5 | Ground | | 6 | Power switch | In |
| 7 | Reset switch | In | 8 | Ground | |
| Power | | | Not Connected | | |
| 9 | Power | Out | 10 | No pin | |

Alternate Front Panel Power LED Header

Figure 27, H shows the location of the alternate front panel power LED header. Pins 1 and 3 of this header duplicate the signals on pins 2 and 4 of the front panel header. If your chassis has a three-pin power LED cable, connect it to this header.

Table 12 shows the pin assignments and signal names for the alternate front panel power LED header.

Table 12. Alternate Front Panel Power LED Header Signal Names

| Pin | Description | In/Out |
|-----|------------------------|--------|
| 1 | Front panel green LED | Out |
| 2 | No pin | |
| 3 | Front panel yellow LED | Out |

Connecting to the Flexible Audio System

After installing the IDT* audio driver from the Intel® Express Installer DVD-ROM, the multi-channel audio feature can be enabled. Figure 28 shows the back panel audio connectors. The default connector assignments are shown in the table.

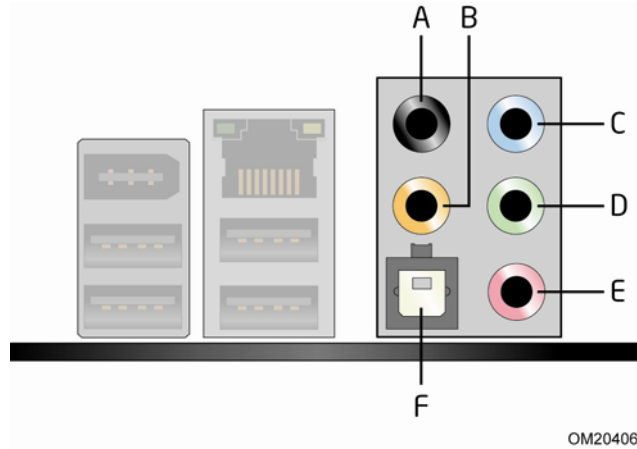

| Item | Description |
|------|---|
| A | Surround Left and Right |
| B | Center Channel and LFE (Subwoofer) |
| C | Side Surround Left and Right/Line In/Retasking Jack |
| D | Line Out |
| E | Mic In |
| F | S/PDIF Digital Audio Out (Optical) |

Figure 28. Back Panel Audio Connectors



NOTE

The back panel line out connector is designed to power either headphones or amplified speakers only. Poor audio quality may occur if passive (non-amplified) speakers are connected to this output.

Connecting Chassis Fan and Power Supply Cables

Connecting Chassis Fan Cables

Connect chassis fan cables to the 3-pin and 4-pin chassis fan headers on the Desktop Board. Figure 29 shows the location of the chassis fan headers.

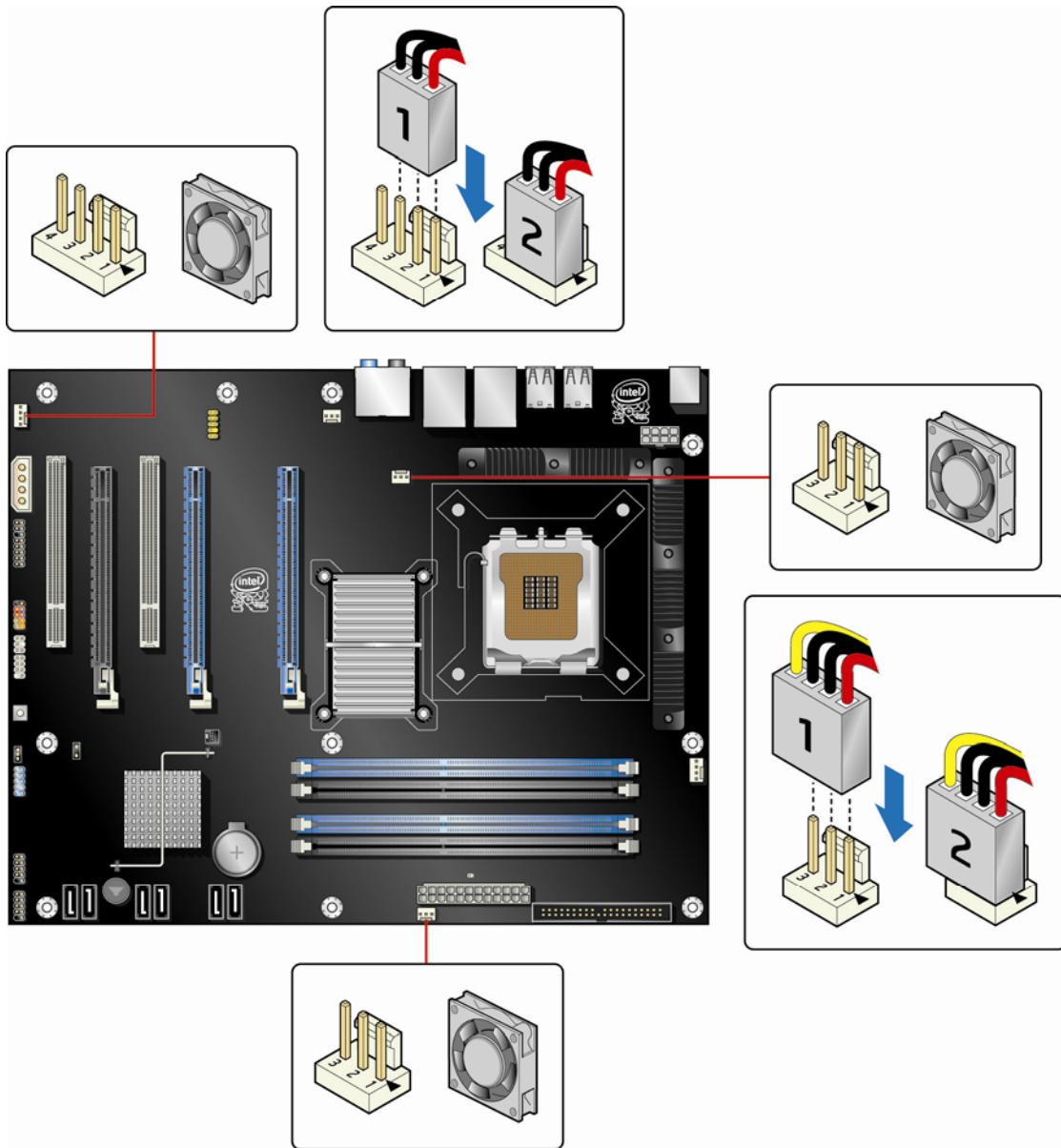

0M20422

Figure 29. Location of the Chassis Fan Headers

Connecting Power Supply Cables



CAUTION

Failure to use an appropriate power supply and/or not connecting the 12 V (2 x 4 pin) power connector to the Desktop Board may result in damage to the board or the system may not function properly.

The 2 x 12 pin main power connector on the Desktop Board is backwards compatible with ATX12V power supplies with 2 x 10 connectors. Use of the 1 x 4 power connector is required with ATX12V power supplies when using PCI Express add-in cards that can consume up to 75 W. Figure 30 shows the location of the power connectors.

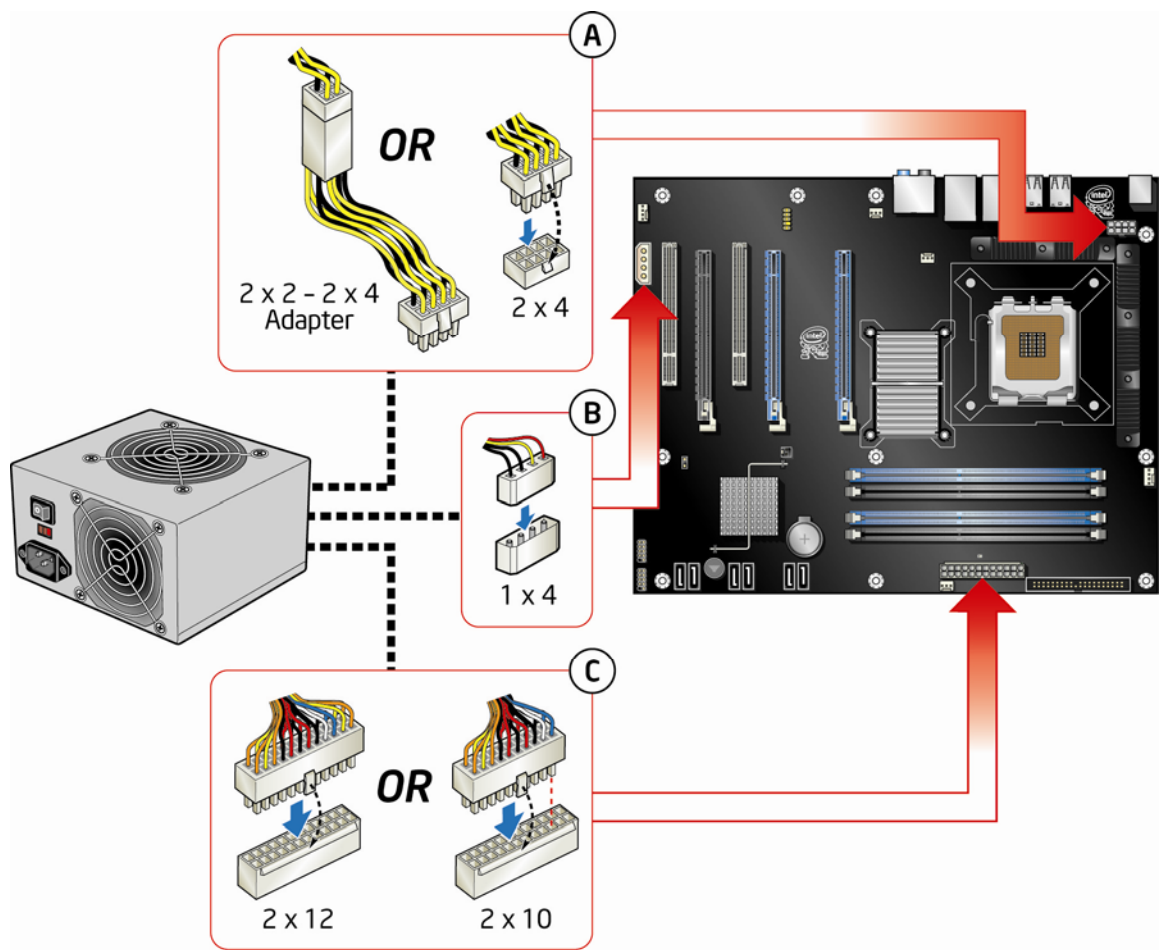

OM20423

Figure 30. Connecting Power Supply Cables

1. Observe the precautions in "Before You Begin" on page 29.
2. Connect the 12 V processor core voltage power supply cable to the 2 x 4 pin connector. Use the 2 x 2 to 2 x 4 adapter if need.



NOTE

Do not use the included 2 x 2 to 2 x 4 adapter when using an Intel® Pentium® processor Extreme Edition or other Intel processor that is not running at its default settings. Doing so may result in damage to the Desktop Board.

3. Connect the 1 x 4 power supply cable to the 1 x 4 connector.
4. Connect the main power supply cable to the 2 x 12 pin connector.

Setting the BIOS Configuration Jumper



NOTE

Always turn off the power and unplug the power cord from the computer before moving the jumper. Moving the jumper with the power on may result in unreliable computer operation.

Figure 31 shows the location of the Desktop Board's BIOS configuration jumper block.

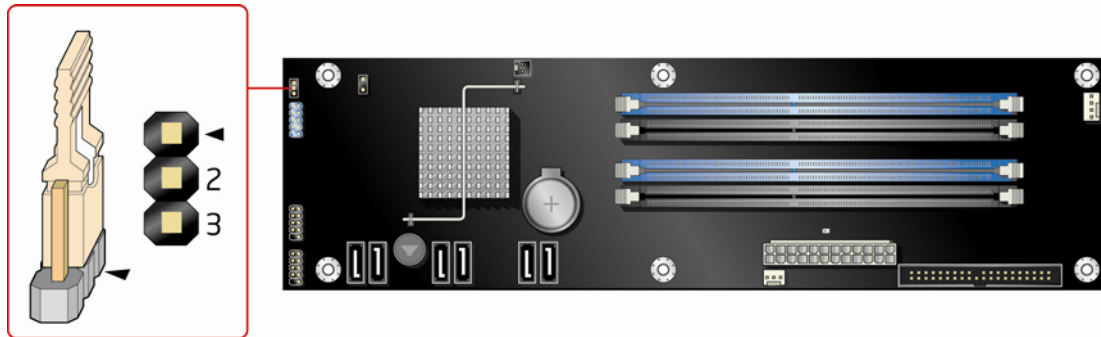

OM20425

Figure 31. Location of the BIOS Configuration Jumper Block

The three-pin BIOS jumper block enables all board configurations to be done in the BIOS Setup program. Table 13 shows the jumper settings for the BIOS Setup program modes.

Table 13. Jumper Settings for the BIOS Setup Program Modes

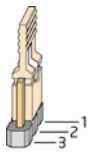
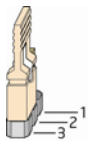
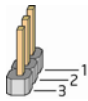
| Jumper Setting | Mode | Description |
|---|------------------------|---|
|  | Normal (default) (1-2) | The BIOS uses the current configuration and passwords for booting. |
|  | Configure (2-3) | After the Power-On Self-Test (POST) runs, the BIOS displays the Maintenance Menu. Use this menu to clear passwords. |
|  | Recovery (None) | The BIOS recovers data in the event of a failed BIOS update. |

Clearing Passwords

This procedure assumes that the board is installed in the computer and the configuration jumper block is set to normal mode.

1. Observe the precautions in "Before You Begin" on page 29.
2. Turn off all peripheral devices connected to the computer. Turn off the computer. Disconnect the computer's power cord from the AC power source (wall outlet or power adapter).
3. Remove the computer cover.
4. Find the configuration jumper block (see Figure 31).
5. Place the jumper on pins 2-3 as shown below.

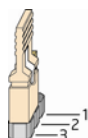

6. Replace the cover, plug in the computer, turn on the computer, and allow it to boot.
7. The computer starts the Setup program. Setup displays the Maintenance menu.
8. Use the arrow keys to select Clear Passwords. Press <Enter> and Setup displays a pop-up screen requesting that you confirm clearing the password. Select Yes and press <Enter>. Setup displays the maintenance menu again.
9. Press <F10> to save the current values and exit Setup.
10. Turn off the computer. Disconnect the computer's power cord from the AC power source.
11. Remove the computer cover.

12. To restore normal operation, place the jumper on pins 1-2 as shown below.

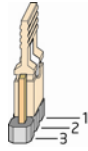

13. Replace the cover, plug in the computer, and turn on the computer.

Replacing the Battery

A coin-cell battery (CR2032) powers the real-time clock and CMOS memory. When the computer is not plugged into a wall socket, the battery has an estimated life of three years. When the computer is plugged in, the standby current from the power supply extends the life of the battery. The clock is accurate to ± 13 minutes/year at 25 °C with 3.3 VSB applied.

When the voltage drops below a certain level, the BIOS Setup program settings stored in CMOS RAM (for example, the date and time) might not be accurate. Replace the battery with an equivalent one. Figure 32 on page 64 shows the location of the battery.



CAUTION

Risk of explosion if the battery is replaced with an incorrect type. Batteries should be recycled where possible. Disposal of used batteries must be in accordance with local environmental regulations.



PRÉCAUTION

Risque d'explosion si la pile usagée est remplacée par une pile de type incorrect. Les piles usagées doivent être recyclées dans la mesure du possible. La mise au rebut des piles usagées doit respecter les réglementations locales en vigueur en matière de protection de l'environnement.



FORHOLDSREGEL

Eksplussionsfare, hvis batteriet erstattes med et batteri af en forkert type. Batterier bør om muligt genbruges. Bortskaffelse af brugte batterier bør foregå i overensstemmelse med gældende miljølovgivning.



OBS!

Det kan oppstå eksplosjonsfare hvis batteriet skiftes ut med feil type. Brukte batterier bør kastes i henhold til gjeldende miljølovgivning.



VIKTIGT!

Risk för explosion om batteriet ersätts med felaktig batterityp. Batterier ska kasseras enligt de lokala miljövårdsbestämmelserna.



VARO

Räjähdysvaara, jos pariston tyyppi on väärä. Paristot on kierrätettävä, jos se on mahdollista. Käytetyt paristot on hävitettävä paikallisten ympäristömääräysten mukaisesti.



VORSICHT

Bei falschem Einsetzen einer neuen Batterie besteht Explosionsgefahr. Die Batterie darf nur durch denselben oder einen entsprechenden, vom Hersteller empfohlenen Batterietyp ersetzt werden. Entsorgen Sie verbrauchte Batterien den Anweisungen des Herstellers entsprechend.



AVVERTIMENTO

Esiste il pericolo di un esplosione se la pila non viene sostituita in modo corretto. Utilizzare solo pile uguali o di tipo equivalente a quelle consigliate dal produttore. Per disfarsi delle pile usate, seguire le istruzioni del produttore.



PRECAUCIÓN

Existe peligro de explosión si la pila no se cambia de forma adecuada. Utilice solamente pilas iguales o del mismo tipo que las recomendadas por el fabricante del equipo. Para deshacerse de las pilas usadas, siga igualmente las instrucciones del fabricante.



WAARSCHUWING

Er bestaat ontploffingsgevaar als de batterij wordt vervangen door een onjuist type batterij. Batterijen moeten zoveel mogelijk worden gerecycled. Houd u bij het weggooien van gebruikte batterijen aan de plaatselijke milieuwetgeving.



ATENÇÃO

Haverá risco de explosão se a bateria for substituída por um tipo de bateria incorreto. As baterias devem ser recicladas nos locais apropriados. A eliminação de baterias usadas deve ser feita de acordo com as regulamentações ambientais da região.



AŚCIAROŻNAŚĆ

Існуе рызыка выбуху, калі заменены акумулятар неправільнага тыпу. Акумулятары павінны, па магчымасці, перепрацоўвацца. Пазбаўляцца ад старых акумулятараў патрэбна згодна з мясцовымі заканадаўствам па экалогіі.



UPOZORNĚNÍ

V případě výměny baterie za nesprávný druh může dojít k výbuchu. Je-li to možné, baterie by měly být recyklovány. Baterie je třeba zlikvidovat v souladu s místními předpisy o životním prostředí.



Προσοχή

Υπάρχει κίνδυνος για έκρηξη σε περίπτωση που η μπαταρία αντικατασταθεί από μία λανθασμένου τύπου. Οι μπαταρίες θα πρέπει να ανακυκλώνονται όταν κάτι τέτοιο είναι δυνατό. Η απόρριψη των χρησιμοποιημένων μπαταριών πρέπει να γίνεται σύμφωνα με τους κατά τόπο περιβαλλοντικούς κανονισμούς.



VIGYÁZAT

Ha a telepet nem a megfelelő típusú telepre cseréli, az felrobbanhat. A telepeket lehetőség szerint újra kell hasznosítani. A használt telepeket a helyi környezetvédelmi előírásoknak megfelelően kell kiselejtezni.



注意

異なる種類の電池を使用すると、爆発の危険があります。リサイクルが可能な地域であれば、電池をリサイクルしてください。使用後の電池を破棄する際には、地域の環境規制に従ってください。



AWAS

Risiko letupan wujud jika bateri digantikan dengan jenis yang tidak betul. Bateri sepatutnya dikitar semula jika boleh. Pelupusan bateri terpakai mestilah mematuhi peraturan alam sekitar tempatan.



OSTRZEŻENIE

Istnieje niebezpieczeństwo wybuchu w przypadku zastosowania niewłaściwego typu baterii. Zużyte baterie należy w miarę możliwości utylizować zgodnie z odpowiednimi przepisami ochrony środowiska.



PRECAUȚIE

Risc de explozie, dacă bateria este înlocuită cu un tip de baterie necorespunzător. Bateriile trebuie reciclate, dacă este posibil. Depozitarea bateriilor uzate trebuie să respecte reglementările locale privind protecția mediului.



ВНИМАНИЕ

При использовании батареи несоответствующего типа существует риск ее взрыва. Батареи должны быть утилизированы по возможности. Утилизация батарей должна проводиться по правилам, соответствующим местным требованиям.



UPOZORNENIE

Ak batériu vymeníte za nesprávny typ, hrozí nebezpečenstvo jej výbuchu. Batérie by sa mali podľa možnosti vždy recyklovať. Likvidácia použitých batérií sa musí vykonávať v súlade s miestnymi predpismi na ochranu životného prostredia.



POZOR

Zamenjava baterije z baterijo drugačnega tipa lahko povzroči eksplozijo. Če je mogoče, baterije reciklirajte. Rabljene baterije zavržite v skladu z lokalnimi okoljevarstvenimi predpisi.



คำเตือน

ระวังการระเบิดที่เกิดจากเปลี่ยนแบตเตอรี่ผิดประเภท หากเป็นไปได้ ควรนำแบตเตอรี่ไปรีไซเคิล การทิ้งแบตเตอรี่ใช้แล้วต้องเป็นไปตามกฎข้อบังคับด้านสิ่งแวดล้อมของท้องถิ่น.



UYARI

Yanlış türde pil takıldığında patlama riski vardır. Piller mümkün olduğunda geri dönüştürülmelidir. Kullanılmış piller, yerel çevre yasalarına uygun olarak atılmalıdır.



ОСТОРОГА

Використовуйте батареї правильного типу, інакше існуватиме ризик вибуху. Якщо можливо, використані батареї слід утилізувати. Утилізація використаних батарей має бути виконана згідно місцевих норм, що регулюють охорону довкілля.



UPOZORNĚNÍ

V případě výměny baterie za nesprávný druh může dojít k výbuchu. Je-li to možné, baterie by měly být recyklovány. Baterie je třeba zlikvidovat v souladu s místními předpisy o životním prostředí.



ETTEVAATUST

Kui patarei asendatakse uue ebasobivat tüüpi patareiga, võib tekkida plahvatusoht. Tühjad patareid tuleb võimaluse korral viia vastavasse kogumispunkti. Tühjade patareide äraviskamisel tuleb järgida kohalikke keskkonnakaitse alaseid reegleid.



FIGYELMEZTETÉS

Ha az elemet nem a megfelelő típusúra cseréli, felrobbanhat. Az elemeket lehetőség szerint újra kell hasznosítani. A használt elemeket a helyi környezetvédelmi előírásoknak megfelelően kell kiselejtezni.



UZMANĪBU

Pastāv eksplozijas risks, ja baterijas tiek nomainītas ar nepareiza veida baterijām. Ja iespējams, baterijas vajadzētu nodot attiecīgos pieņemšanas punktus. Bateriju izmešanai atkritumos jānotiek saskaņā ar vietējiem vides aizsardzības noteikumiem.



DĒMESIO

Naudojant netinkamo tipo baterijas įrenginys gali sprogti. Kai tik įmanoma, baterijas reikia naudoti pakartotinai. Panaudotas baterijas išmesti būtina pagal vietinius aplinkos apsaugos nuostatus.



ATTENZJONI

Riskju ta' splużjoni jekk il-batterija tinbidel b'tip ta' batterija mhux korrett. Il-batteriji għandhom jiġu riċiklati fejn hu possibbli. Ir-rimi ta' batteriji użati għandu jsir skond ir-regolamenti ambjentali lokali.



OSTRZEŻENIE

Ryzyko wybuchu w przypadku wymiany na baterie niewłaściwego typu. W miarę możliwości baterie należy poddać recyklingowi. Zużytych baterii należy pozbywać się zgodnie z lokalnie obowiązującymi przepisami w zakresie ochrony środowiska.

To replace the battery, follow these steps:

1. Observe the precautions in "Before You Begin" (see page 29).
2. Turn off all peripheral devices connected to the computer. Disconnect the computer's power cord from the AC power source (wall outlet or power adapter).
3. Remove the computer cover.
4. Locate the battery on the board (see Figure 32).
5. With a medium flat-bladed screwdriver, gently pry the battery free from its connector. Note the orientation of the "+" and "-" on the battery.
6. Install the new battery in the connector, orienting the "+" and "-" correctly.
7. Replace the computer cover.

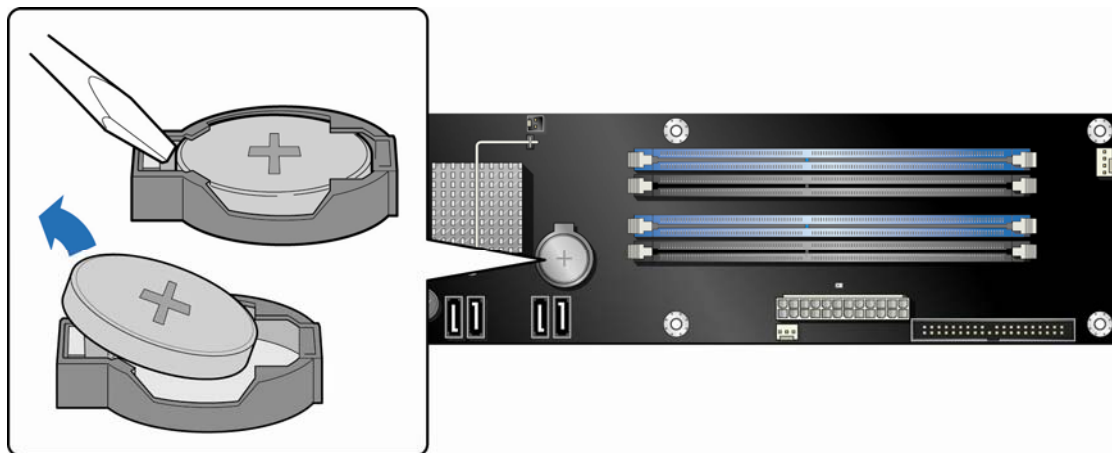

OM20426

Figure 32. Removing the Battery

3 Updating the BIOS

The BIOS Setup program can be used to view and change the BIOS settings for the computer. You can access the BIOS Setup program by pressing the <F2> key after the Power-On Self-Test (POST) memory test begins and before the operating system boot begins.

This chapter tells you how to update the BIOS by either using the Intel Express BIOS Update utility or the Iflash Memory Update utility, and how to recover the BIOS if an update fails.

Updating the BIOS with the Intel[®] Express BIOS Update Utility

With the Intel Express BIOS Update utility you can update the system BIOS while in the Windows environment. The BIOS file is included in an automated update utility that combines the functionality of the Intel[®] Flash Memory Update Utility and the ease of use of Windows-based installation wizards.

To update the BIOS with the Intel Express BIOS Update utility:

1. Go to the Intel World Wide Web site:
<http://support.intel.com/support/motherboards/desktop/>
2. Navigate to the DX38BT page, click “[view] Latest BIOS updates,” and select the Express BIOS Update utility file.
3. Download the file to your hard drive. (You can also save this file to a removable USB device. This is useful if you are updating the BIOS for multiple identical systems.)
4. Close all other applications. This step is required. Your system will be rebooted at the last Express BIOS Update window.
5. Double-click the executable file from the location on your hard drive where it was saved. This runs the update program.
6. Follow the instructions provided in the dialog boxes to complete the BIOS update.

Updating the BIOS with the ISO Image BIOS Update File or the Iflash Memory Update Utility

You can use the information in this section to update the BIOS using either the Iflash Memory Update Utility or the ISO Image BIOS update file.

Obtaining the BIOS Update File

You can update to a new version of the BIOS by using the ISO Image BIOS update file (recommended), or Iflash BIOS update file.

The ISO Image BIOS update file is a standardized image of a bootable CD-ROM that can be used to create a bootable CD that will update the BIOS.

The Iflash BIOS update file is a compressed file that contains the files you need to update the BIOS. The Iflash BIOS update file contains:

- New BIOS file (including the Intel® Management Engine Firmware Image)
- Intel® Integrator Toolkit Configuration File (optional)
- Intel Flash Memory Update Utility

You can obtain either of these files through your computer supplier or by navigating to the Desktop Board DX38BT page on the Intel World Wide Web site at:

<http://support.intel.com/support/motherboards/desktop>

Navigate to the DX38BT page, click “[view] Latest BIOS updates,” and select the ISO Image BIOS Update or Iflash BIOS Update utility file.

Updating the BIOS with the ISO Image BIOS Update File

The ISO Image BIOS update allows for the update of an Intel® Desktop Board BIOS to the latest production release regardless of the operating system installed on the computer's hard drive and without the need to remove the BIOS configuration jumper. It requires a blank CD-R, a read/writeable CD drive, and software capable of uncompressing and writing the ISO image file to CD.

The image uses ISOLINUX* bootloader and automatically launches a script to upgrade the BIOS via the Iflash utility.

**CAUTION**

Do not interrupt the process or the system may not function properly.

Follow these instructions to upgrade the BIOS using the ISO Image BIOS file:

1. Download the ISO Image BIOS file.
2. Using software capable of uncompressing and writing an ISO image file to CD, burn the data to a blank CD.

**NOTE**

Copying the ISO Image BIOS file to CD will not work. The completed CD should contain multiple files and a directory.

3. Insert the CD that was created in the CD-ROM drive of the computer to be upgraded and boot the system.
4. When the "Press ENTER to continue booting from CD-ROM" prompt appears, press the Enter key. The system will boot from the hard drive if no key is pressed within 15 seconds.
5. At the "Welcome to the Intel Desktop Board BIOS Upgrade CD-ROM" page, press any key to confirm the BIOS upgrade operation.
6. Wait for the BIOS upgrade process to complete.

**CAUTION**

DO NOT POWER DOWN YOUR COMPUTER before the update is complete. The update may take up to 5 minutes.

Updating the BIOS with the Iflash Memory Update Utility

With the Iflash Memory update utility you can update the system BIOS from a bootable CD-ROM, bootable USB flash drive, or other bootable USB media. The utility available on the Intel World Wide Web site provides a simple method for creating a bootable CD-ROM that will automatically update your BIOS. The Iflash BIOS update files can also be extracted locally to your hard drive and copied to a bootable USB flash drive or other bootable USB media.

The Iflash Memory update utility allows you to:

- Update the BIOS and Intel Management Engine in flash memory
- Update the language section of the BIOS

**NOTE**

Review the instructions distributed with the update utility before attempting a BIOS update.



CAUTION

Do not interrupt the process or the system may not function properly.

1. Uncompress the BIOS update file and copy the .BIO file, IFLASH.EXE, and .ITK file (optional) to a bootable USB flash drive or other bootable USB media.
2. Configure the BIOS or use the F10 option during POST to boot to the USB device.
3. Manually run the IFLASH.EXE file from the USB device and manually update the BIOS.

Recovering the BIOS

It is unlikely that anything will interrupt the BIOS update; however, if an interruption occurs, the BIOS could be damaged. Due to BIOS size and recovery requirements, a CD-R with the .BIO file in the root directory will be required.

Related Links:

For more information about updating the Intel Desktop Board BIOS or recovering from a BIOS update failure, go to:

<http://support.intel.com/support/motherboards/desktop/sb/CS-022312.htm>

4 Configuring for RAID (Intel® Matrix Storage Technology)



NOTE

Intel Matrix Storage Technology requires Microsoft Windows Vista or Microsoft Windows XP operating system and SATA hard drives.

Configuring the BIOS for Intel Matrix Storage Technology

1. Assemble your system and attach two or more SATA hard drives to the SATA connectors.
2. Enter system BIOS Setup by pressing <F2> after the Power-On-Self-Test (POST) memory tests begin.
3. Go to **Advanced** → **Drive Configuration** → **Configure SATA as**; ensure that **RAID** is selected.
4. Then save your settings by pressing <F10>.

Creating Your RAID Set

1. Upon re-boot, you will see the following Intel Matrix Storage Manager option ROM status message on the screen: Press <Ctrl-I> to enter the RAID Configuration Utility. Press <Ctrl-I> and enter the RAID Configuration Utility.
2. In the Intel Matrix Storage Manager option ROM Main Menu, select option #1: Create RAID Volume. Enter a volume name and press <Enter>. **NOTE:** The RAID Volume name must be in English alphanumeric ASCII characters.
3. Use the arrow keys to select RAID 0 or RAID 1 (if only two SATA drives are available), RAID 5 and RAID 10 (these options will only appear if three or four SATA drives are installed respectively). Press <Enter> once you have selected the RAID LEVEL.
4. Select the drives to be used in the RAID array (only if there are more than two drives available) and press <Enter>.
5. Select the strip size, if necessary, and press <Enter>.
6. Enter the size of the volume (if you enter less than the maximum volume size, you can then create a second RAID array on the remaining portion of your volume) and press <Enter>.
7. Finally, press <Enter> to **Create Volume**.
8. Exit the Option ROM user interface by pressing <Esc> or going to the EXIT option in the MAIN MENU.

Loading the Intel Matrix Storage Technology RAID Drivers and Software

1. Begin Windows Setup by booting from the Windows installation CD.
2. At the beginning of Windows Setup, press <F6> to install a third-party SCSI or RAID driver. When prompted, insert the diskette labeled Intel Matrix Storage Technology RAID Driver. Install the Intel® ICH9 SATA RAID Controller driver.
3. Finish the Windows installation and install all necessary drivers.
4. Install the Intel Matrix Storage Console software via the Intel Express Installer CD included with your Desktop Board or after downloading it from the Internet at <http://support.intel.com/support/motherboards/desktop/>. The Intel Matrix Storage Console software can be used to manage the RAID configuration.

Setting Up a “RAID Ready” System

The Intel Matrix Storage Technology Console software offers the flexibility to upgrade from a single Serial ATA drive to RAID without reinstalling the operating system, when a second SATA hard drive is added to the system.

Follow the steps described above in: "Configuring the BIOS for Intel Matrix Storage Technology" and "Loading the Intel Matrix Storage Technology RAID Drivers and Software."

Once additional SATA drives have been added to the system, open the Intel Matrix Storage Technology Console Software and follow the directions to update to a RAID setup.

A Error Messages and Indicators

Desktop Board DX38BT reports POST errors in two ways:

- By sounding a beep code
- By displaying an error message on the monitor

BIOS Beep Codes

The BIOS also issues a beep code (one long tone followed by two short tones) during POST if the video configuration fails (a faulty video card or no card installed) or if an external ROM module does not properly checksum to zero. Table 14 lists the BIOS codes.

Table 14. Beep Codes

| Beep | Description |
|-------|--------------------------------|
| 3 | No memory |
| Siren | Processor overheat (on reboot) |

BIOS Error Messages

When a recoverable error occurs during the POST, the BIOS displays an error message describing the problem. Table 15 gives an explanation of the BIOS error messages.

Table 15. BIOS Error Messages

| Error Message | Explanation |
|------------------------------|---|
| PROCESSOR_THERMAL_TRIP_ERROR | Processor was previously shutdown due to a thermal event (overheating). |
| MULTI_BIT_ECC_ERROR | The firmware has detected that a Multi-Bit ECC Error occurred. |
| SINGLE_BIT_ECC_ERROR | The firmware has detected that a Single-Bit ECC Error occurred. |
| CMOS_BATTERY_ERROR | The firmware has detected that a CMOS battery failure occurred. |
| CMOS_CHECKSUM_ERROR | The firmware has detected that a CMOS Checksum Error occurred. |
| CMOS_TIMER_ERROR | The firmware has detected that the system date/time has not been set. |
| MEMORY_SIZE_DECREASE_ERROR | The firmware has detected that the system memory has decreased. |
| INTRUDER_DETECTION_ERROR | The system chassis was opened. |
| SPD_TOLER_ERROR | SERIAL PRESENCE DETECT (SPD) device data missing or inconclusive. Properly programmed SPD device data is required for reliable operation. |
| MEM_OPTIMAL_ERROR | The installed amount of memory in Channel A is not equal to the amount of memory in Channel B. Maximum memory performance is achieved with equal amounts of memory installed in each channel. |

B Regulatory Compliance

This appendix contains the following regulatory compliance information for Desktop Board DX38BT:

- Safety standards
- European Union Declaration of Conformity statement
- Product Ecology statements
- Electromagnetic Compatibility (EMC) regulations
- Product certifications

Safety Standards

Desktop Board DX38BT complies with the safety standards stated in Table 16 when correctly installed in a compatible host system.

Table 16. Safety Standards

| Regulation | Title |
|----------------------------------|---|
| CSA/UL 60950-1, First Edition | Information Technology Equipment – Safety - Part 1: General Requirements (USA and Canada) |
| EN 60950-1:2006, Second Edition | Information Technology Equipment – Safety - Part 1: General Requirements (European Union) |
| IEC 60950-1:2005, Second Edition | Information Technology Equipment – Safety - Part 1: General Requirements (International) |

Place Battery Marking

There is insufficient space on this Desktop Board to provide instructions for replacing and disposing of the Lithium ion coin cell battery. For system safety certification, the statement below or an equivalent statement is required to be permanently and legibly marked on the chassis near the battery.



CAUTION

Risk of explosion if the battery is replaced with an incorrect type. Batteries should be recycled where possible. Disposal of used batteries must be in accordance with local environmental regulations.

A suitable caution label is included with Desktop Board DX38BT.

Related Links

For information about replacing the battery, go to page 60.

European Union Declaration of Conformity Statement

We, Intel Corporation, declare under our sole responsibility that the product Intel® Desktop Board DX38BT is in conformity with all applicable essential requirements necessary for CE marking, following the provisions of the European Council Directives 2004/108/EC (EMC Directive) and 2006/95/EC (Low Voltage Directive).

The product is properly CE marked demonstrating this conformity and is for distribution within all member states of the EU with no restrictions.



This product follows the provisions of the European Directives 2004/108/EC and 2006/95/EC.

Čeština Tento výrobek odpovídá požadavkům evropských směrnic 2004/108/EC a 2006/95/EC.

Dansk Dette produkt er i overensstemmelse med det europæiske direktiv 2004/108/EC & 2006/95/EC.

Dutch Dit product is in navolging van de bepalingen van Europees Directief 2004/108/EC & 2006/95/EC.

Eesti Antud toode vastab Euroopa direktiivides 2004/108/EC ja 2006/95/EC kehtestatud nõuetele.

Suomi Tämä tuote noudattaa EU-direktiivin 2004/108/EC & 2006/95/EC määräyksiä.

Français Ce produit est conforme aux exigences de la Directive Européenne 2004/108/EC & 2006/95/EC.

Deutsch Dieses Produkt entspricht den Bestimmungen der Europäischen Richtlinie 2004/108/EC & 2006/95/EC.

Ελληνικά Το παρόν προϊόν ακολουθεί τις διατάξεις των Ευρωπαϊκών Οδηγιών 2004/108/EC και 2006/95/EC.

Magyar E termék megfelel a 2004/108/EC és 2006/95/EC Európai Irányelv előírásainak.

Icelandic Þessi vara stenst reglugerð Evrópska Efnahags Bandalagsins númer 2004/108/EC & 2006/95/EC.

Italiano Questo prodotto è conforme alla Direttiva Europea 2004/108/EC & 2006/95/EC.

Latviešu Šis produkts atbilst Eiropas Direktīvu 2004/108/EC un 2006/95/EC noteikumiem.

Lietuvių Šis produktas atitinka Europos direktyvų 2004/108/EC ir 2006/95/EC nuostatas.

Malti Dan il-prodott hu konformi mal-provvedimenti tad-Direttivi Ewropej 2004/108/EC u 2006/95/EC.

Norsk Dette produktet er i henhold til bestemmelsene i det europeiske direktivet 2004/108/EC & 2006/95/EC.

Polski Niniejszy produkt jest zgodny z postanowieniami Dyrektyw Unii Europejskiej 2004/108/EC i 2006/95/EC.

Portuguese Este produto cumpre com as normas da Diretiva Europeia 2004/108/EC & 2006/95/EC.

Español Este producto cumple con las normas del Directivo Europeo 2004/108/EC & 2006/95/EC.

Slovensky Tento produkt je v súlade s ustanoveniami európskych direktív 2004/108/EC a 2006/95/EC.

Slovenščina Izdelek je skladen z določbami evropskih direktiv 2004/108/EC in 2006/95/EC.

Svenska Denna produkt har tillverkats i enlighet med EG-direktiv 2004/108/EC & 2006/95/EC.

Türkçe Bu ürün, Avrupa Birliği'nin 2004/108/EC ve 2006/95/EC yönergelerine uyar.

Product Ecology Statements

The following information is provided to address worldwide product ecology concerns and regulations.

Recycling Considerations

As part of its commitment to environmental responsibility, Intel has implemented the Intel® Product Recycling Program to allow retail consumers of Intel's branded products to return used products to selected locations for proper recycling.

Please consult http://www.intel.com/intel/other/ehs/product_ecology for the details of this program, including the scope of covered products, available locations, shipping instructions, terms and conditions, etc.

中文

作为其对环境责任之承诺的部分，英特尔已实施 Intel Product Recycling Program（英特尔产品回收计划），以允许英特尔品牌产品的零售消费者将使用过的产品退还至指定地点作恰当的重复使用处理。

请参考http://www.intel.com/intel/other/ehs/product_ecology了解此计划的详情，包括涉及产品之范围、回收地点、运送指导、条款和条件等。

Deutsch

Als Teil von Intels Engagement für den Umweltschutz hat das Unternehmen das Intel Produkt-Recyclingprogramm implementiert, das Einzelhandelskunden von Intel Markenprodukten ermöglicht, gebrauchte Produkte an ausgewählte Standorte für ordnungsgemäßes Recycling zurückzugeben.

Details zu diesem Programm, einschließlich der darin eingeschlossenen Produkte, verfügbaren Standorte, Versandanweisungen, Bedingungen usw., finden Sie auf der http://www.intel.com/intel/other/ehs/product_ecology

Español

Como parte de su compromiso de responsabilidad medioambiental, Intel ha implantado el programa de reciclaje de productos Intel, que permite que los consumidores al detalle de los productos Intel devuelvan los productos usados en los lugares seleccionados para su correspondiente reciclado.

Consulte la http://www.intel.com/intel/other/ehs/product_ecology para ver los detalles del programa, que incluye los productos que abarca, los lugares disponibles, instrucciones de envío, términos y condiciones, etc.

Français

Dans le cadre de son engagement pour la protection de l'environnement, Intel a mis en œuvre le programme Intel Product Recycling Program (Programme de recyclage des produits Intel) pour permettre aux consommateurs de produits Intel de recycler les produits usés en les retournant à des adresses spécifiées.

Visitez la page Web http://www.intel.com/intel/other/ehs/product_ecology pour en savoir plus sur ce programme, à savoir les produits concernés, les adresses disponibles, les instructions d'expédition, les conditions générales, etc.

日本語

インテルでは、環境保護活動の一環として、使い終わったインテルブランド製品を指定の場所へ返送していただき、リサイクルを適切に行えるよう、インテル製品リサイクルプログラムを発足させました。

対象製品、返送先、返送方法、ご利用規約など、このプログラムの詳細情報は、http://www.intel.com/intel/other/ehs/product_ecology (英語)をご覧ください。

Malay

Sebagai sebahagian daripada komitmennya terhadap tanggungjawab persekitaran, Intel telah melaksanakan Program Kitar Semula Produk untuk membenarkan pengguna-pengguna runcit produk jenama Intel memulangkan produk terguna ke lokasi-lokasi terpilih untuk dikitar semula dengan betul.

Sila rujuk http://www.intel.com/intel/other/ehs/product_ecology untuk mendapatkan butir-butir program ini, termasuklah skop produk yang dirangkumi, lokasi-lokasi tersedia, arahan penghantaran, terma & syarat, dsb.

Portuguese

Como parte deste compromisso com o respeito ao ambiente, a Intel implementou o Programa de Reciclagem de Produtos para que os consumidores finais possam enviar produtos Intel usados para locais selecionados, onde esses produtos são reciclados de maneira adequada.

Consulte o site http://www.intel.com/intel/other/ehs/product_ecology (em Inglês) para obter os detalhes sobre este programa, inclusive o escopo dos produtos cobertos, os locais disponíveis, as instruções de envio, os termos e condições, etc.

Russian

В качестве части своих обязательств к окружающей среде, в Intel создана программа утилизации продукции Intel (Product Recycling Program) для предоставления конечным пользователям марок продукции Intel возможности возврата используемой продукции в специализированные пункты для должной утилизации.

Пожалуйста, обратитесь на веб-сайт http://www.intel.com/intel/other/ehs/product_ecology за информацией об этой программе, принимаемых продуктах, местах приема, инструкциях об отправке, положениях и условиях и т.д.

Türkçe

Intel, çevre sorumluluğuna bağlılığının bir parçası olarak, perakende tüketicilerin Intel markalı kullanılmış ürünlerini belirlenmiş merkezlere iade edip uygun şekilde geri dönüştürmesini amaçlayan Intel Ürünleri Geri Dönüşüm Programı'nı uygulamaya koymuştur.

Bu programın ürün kapsamı, ürün iade merkezleri, nakliye talimatları, kayıtlar ve şartlar v.s dahil bütün ayrıntılarını öğrenmek için lütfen http://www.intel.com/intel/other/ehs/product_ecology web sayfasına gidin.

Lead-free 2LI/Pb-free 2LI Board

The electronics industry is transitioning to European Union (EU) Restriction of Hazardous Substances (RoHS)-compliant products. The RoHS legislation restricts the use of six materials. One of these restricted materials is lead. Lead is the most common and problematic of the RoHS restricted materials.

There are exemptions in RoHS that allow the use of lead in some very limited locations in electronic products. Maximum lead concentration values have been established for RoHS-compliant electronic products that allow up to 1000 ppm of lead.



Lead-free/Pb-free is a nickname that is often used (or misused) for RoHS-compliant products. In this case, the term "Lead-free/Pb-free" means that lead has been removed where required by the RoHS legislation but still may exist as an impurity below 1000 ppm.

The term "Lead-free 2LI/Pb-free 2LI" means lead-free second level interconnect (2LI). The balls, leads, or pads used to connect the component to a printed circuit board are lead-free, but the first level interconnect (FLI) is not lead-free. The use of lead in the FLI is acceptable because of the RoHS "flip chip" or "die bump" interconnect exemption.

Desktop Board DX38BT is a lead-free second level interconnect product. Table 17 shows the lead-free second level interconnect marks as they appear on the board and accompanying collateral. These marks are based on JEDEC standard J-STD-609, "Marking and Labeling of Components, PCBs and PCBAs to Identify Lead, Lead Free and Other Attributes."

For more information concerning Intel's lead-free initiatives, refer to:
<http://www.intel.com/technology/silicon/leadfree.htm>.

Table 17. Lead-Free Second Level Interconnect Marks

| Description | Mark |
|--|--|
| <p>This symbol is used to identify electrical and electronic assemblies and components in which the Pb concentration level in the Desktop Board substrate and the solder connections from the board to the components (second-level interconnect) is not greater than 0.1% by weight (1000 ppm).</p> | <div style="text-align: center;">  2nd Level Interconnect </div> <p style="text-align: center;">or</p> <div style="text-align: center;">  2nd lvl Intct </div> <p style="text-align: center;">or</p> <div style="text-align: center;">  2LI </div> |

Restriction of Hazardous Substances (RoHS)

EU RoHS

EU RoHS Directive 2002/95/EC restricts the use of the following six materials in various types of electronic and electrical equipment:

- Lead
- Mercury
- Cadmium
- Hexavalent chromium
- Polybrominated biphenyls (PBB)
- Polybrominated diphenyl ether (PBDE)

The maximum concentrations allowed are 0.1% or 1000 ppm (except for cadmium, which is limited to 0.01% or 100 ppm) by weight of homogeneous material.

Desktop Board DX38BT complies with these restrictions.

China RoHS

“China RoHS” is the term used by industry generally to describe legislation implemented by the Ministry of Information Industry (MII) in the People's Republic of China for the control of pollution by electronic information products (EIP). The official title of the China RoHS regulation is “Management Methods for Controlling Pollution by Electronic Information Products.”

China RoHS bans the same substances and has the same limits as EU RoHS. However, the China RoHS regulation requires specific product marking and a self-declaration of the controlled substances contained in each product.

Desktop Board DX38BT is a China RoHS-compliant product.

The required China RoHS mark indicates the product’s Environmental Friendly Usage Period (EFUP). The EFUP is defined as the number of years for which listed controlled substances will not leak or chemically deteriorate while in the product. The EFUP for Intel Desktop Boards has been determined to be 10 years.

The EFUP for Desktop Board DX38BT is shown in Table 18.

Table 18. China RoHS Environmentally Friendly Use Period Mark

| Description | Mark |
|--|--|
| <p>This is an example of the symbol used on Intel Desktop Boards and associated collateral. The color of the mark may vary depending upon the application. The Environmental Friendly Usage Period (EFUP) for Intel Desktop Boards has been determined to be 10 years.</p> |  |

The China MII also stipulates that a material Self Declaration Table (SDT) must be included in a product’s user documentation. The SDT for Desktop Board DX38BT is shown in Figure 33.

关于符合中国《电子信息产品污染控制管理办法》的声明

**Management Methods on Control of Pollution from
Electronic Information Products
(China RoHS declaration)**

产品中有毒有害物质的名称及含量

| 部件名称 (Parts) | 有毒有害物质或元素 | | | | | |
|---|-----------|-----------|-----------|---------------|---------------|-----------------|
| | 铅 (Pb) | 汞 (Hg) | 镉 (Cd) | 六价铬 (Cr6+) | 多溴联苯 (PBB) | 多溴二苯醚 (PBDE) |
| 主板组件 Motherboard Assembly | × | ○ | ○ | ○ | ○ | ○ |
| <p>○：表示该有毒有害物质在该部件所有均质材料中的含量均在 SJ/T 11363-2006 标准规定的限量要求以下。</p> <p>○：Indicates that this hazardous substance contained in all homogeneous materials of this part is below the limit requirement in SJ/T 11363-2006.</p> <p>×：表示该有毒有害物质至少在该部件的某一均质材料中的含量超出 SJ/T 11363-2006 标准规定的限量要求。</p> <p>×：Indicates that this hazardous substance contained in at least one of the homogeneous materials of this part is above the limit requirement in SJ/T 11363-2006.</p> <p>对销售之日的所售产品,本表显示我公司供应链的电子信息产品可能包含这些物质。注意：在所售产品中可能会也可能不会含有所有所列的部件。</p> <p>This table shows where these substances may be found in the supply chain of our electronic information products, as of the date of sale of the enclosed product. Note that some of the component types listed above may or may not be a part of the enclosed product.</p> | | | | | | |

Figure 33. Desktop Board DX38BT China RoHS Material Self Declaration Table

EMC Regulations

Desktop Board DX38BT complies with the EMC regulations stated in Table 19 when correctly installed in a compatible host system.

Table 19. EMC Regulations

| Regulation (Class B) | Title |
|---------------------------------|---|
| FCC 47 CFR Part 15, Subpart B | Title 47 of the Code of Federal Regulations, Part 15, Subpart B, Radio Frequency Devices. (USA) |
| ICES-003 Issue 4 | Interference-Causing Equipment Standard, Digital Apparatus. (Canada) |
| EN55022:2006 | Limits and methods of measurement of Radio Interference Characteristics of Information Technology Equipment. (European Union) |
| EN55024:1998 | Information Technology Equipment – Immunity Characteristics Limits and methods of measurement. (European Union) |
| EN55022:2006 | Australian Communications Authority, Standard for Electromagnetic Compatibility. (Australia and New Zealand) |
| CISPR 22:2005 +A1:2005 +A2:2006 | Limits and methods of measurement of Radio Disturbance Characteristics of Information Technology Equipment. (International) |
| CISPR 24:1997 +A1:2001 +A2:2002 | Information Technology Equipment – Immunity Characteristics – Limits and Methods of Measurement. (International) |
| VCCI V-3/2007.04, V-4/2007.04 | Voluntary Control for Interference by Information Technology Equipment (Japan) |

Japanese Kanji statement translation: This is a Class B product based on the standard of the Voluntary Control Council for Interference from Information Technology Equipment (VCCI). If this is used near a radio or television receiver in a domestic environment, it may cause radio interference. Install and use the equipment according to the instruction manual.

この装置は、情報処理装置等電波障害自主規制協議会（VCCI）の基準に基づくクラスB 情報技術装置です。この装置は、家庭環境で使用することを目的としていますが、この装置がラジオやテレビジョン受信機に近接して使用されると、受信障害を引き起こすことがあります。
取扱説明書に従って正しい取り扱いをして下さい。

Korean Class B statement translation: This is household equipment that is certified to comply with EMC requirements. You may use this equipment in residential environments and other non-residential environments.

이 기기는 가정용으로 전자파적합등록을 한 기기로서
주거지역에서는 물론 모든 지역에서 사용할 수 있습니다.

Ensure Electromagnetic Compatibility (EMC) Compliance

Before computer integration, make sure that the power supply and other modules or peripherals, as applicable, have passed Class B EMC testing and are marked accordingly.

Pay close attention to the following when reading the installation instructions for the host chassis, power supply, and other modules:

- Product certifications or lack of certifications
- External I/O cable shielding and filtering
- Mounting, grounding, and bonding requirements
- Keying connectors when mating the wrong connectors could be hazardous







If the power supply and other modules or peripherals, as applicable, are not Class B EMC compliant before integration, then EMC testing may be required on a representative sample of the newly completed computer.

Product Certifications

Board-Level Certification Markings

Desktop Board DX38BT has the product certification markings shown in Table 20.

Table 20. Product Certification Markings

| Description | Mark |
|--|---|
| UL joint US/Canada Recognized Component mark. Includes adjacent UL file number for Intel Desktop Boards: E210882. |  |
| FCC Declaration of Conformity logo mark for Class B equipment. Includes Intel name and DX38BT model designation. |  |
| CE mark. Declaring compliance to European Union (EU) EMC directive and Low Voltage directive. |  |
| Australian Communications Authority (ACA) and New Zealand Radio Spectrum Management (NZ RSM) C-tick mark. Includes adjacent Intel supplier code number, N-232. |  |
| Japan VCCI (Voluntary Control Council for Interference) mark. |  |
| S. Korea MIC (Ministry of Information and Communication) mark. Includes adjacent MIC certification number: CPU-DX38BT (B). |  |
| Taiwan BSMI (Bureau of Standards, Metrology and Inspections) mark. Includes adjacent Intel company number, D33025. |  |
| Printed wiring board manufacturer's recognition mark. Consists of a unique UL recognized manufacturer's logo, along with a flammability rating (solder side). | V-0 |

Chassis and Component Certifications

Ensure that the chassis and certain components; such as the power supply, peripheral drives, wiring, and cables; are components certified for the country or market where used. Agency certification marks on the product are proof of certification. Typical product certifications include:

In Europe

The CE marking signifies compliance with all applicable European requirements. If the chassis and other components are not properly CE marked, a supplier's Declaration of Conformity statement to the European EMC directive and Low Voltage directive (as applicable), should be obtained. Additionally, other directives, such as the Radio and Telecommunications Terminal Equipment (R&TTE) directive may also apply depending on product features.

In the United States

A certification mark by a Nationally Recognized Testing Laboratory (NRTL) such as UL, CSA, or ETL signifies compliance with safety requirements. Wiring and cables must also be UL listed or recognized and suitable for the intended use. The FCC Class B logo for home or office use signifies compliance with electromagnetic interference (EMI) requirements.

In Canada

A nationally recognized certification mark such as CSA or cUL signifies compliance with safety requirements. The Industry Canada statement at the front of this product guide demonstrates compliance with Canadian EMC regulations.

